

TERMINAL BLOCKS

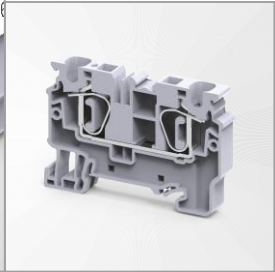

PRODUCT CATALOGUE
2023-2024

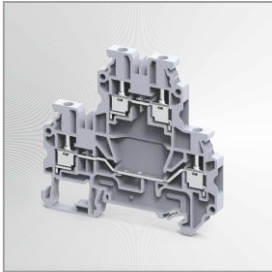
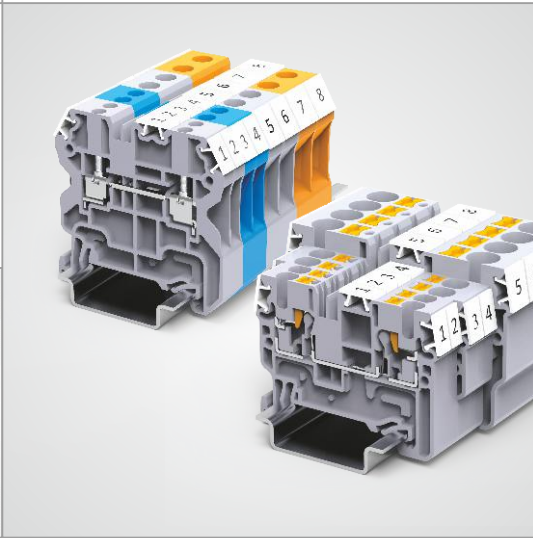
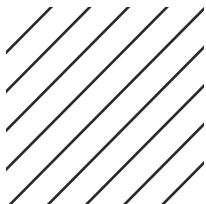
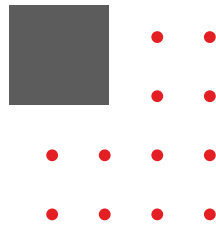
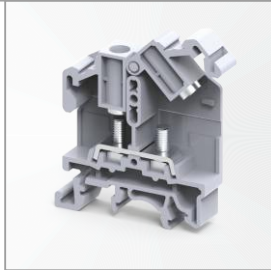

INDEX

COMPANY PROFILE	1 - 4
CP SERIES PUSH-IN TERMINAL BLOCKS	5 - 46
CX SERIES SPRING CLAMP TERMINAL BLOCKS	47 - 104
CY SERIES SCREW TERMINAL BLOCKS	105 - 130
CTS SERIES SCREW CLAMP TERMINAL BLOCKS	131 - 208
STUD & BOLT TYPE TERMINAL BLOCKS	209 - 239
MELAMINE TERMINAL BLOCKS	240 - 260
ACCESSORIES	261 - 282
PROFESSIONAL TOOLS	283 - 285
DIN RAIL MOUNTED SOCKETS & SWITCHES	287 - 288
TECHNICAL REFERENCE	289 - 306
ALPHABETICAL INDEX	307 - 314



A story of **billions of electrical connections** made over 4 decades

From very humble beginnings to becoming one of the leading manufacturers of Terminal Blocks in the world, Connectwell is a dynamic organization focused on making the highest quality electro mechanical and electronic products.

15+ international product certifications backed by the most stringent quality standards put our products through 40+ quality tests. This has ensured a ready acceptance of our products across 80+ countries and in thousands of projects and applications.

With world class manufacturing infrastructure and systems which are ISO certified, Connectwell today has become a synonym for

... The Right Connection

Making A **Million** Connections Everyday

VISION

- We will build a brand that puts people at the centre of it's business.
- For our employees we will create an environment which inspires them to achieve higher goals.
- For our customers we will provide products which bring them the right value.
- For the society at large we will create meaningful employment and will support those in need.

MISSION

Connectwell is dedicated to achieve customer satisfaction by, supplying the Right Product, at the Right Time and at the Right Cost.

CONNECTWELL TODAY

44 Years

Delighting Customers

300+

Channel Partners

1 Million

Connections Made Everyday

15+

Global Product Approvals

40+

Quality Tests

80+

Countries Serviced

OUR STRENGTHS

From product conceptualization to realization, we are well equipped with the latest software and high precision machinery to meet the requirements of our customers. Some of these strengths are listed below



**INJECTION & COMPRESSION
MOULDING**



**AUTOMATED
WAREHOUSE**

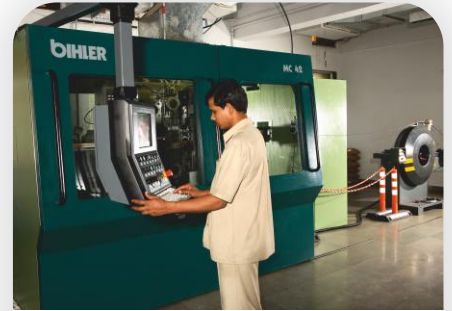

**SHEETA METAL
PROCESSING**



**TOOL DEVELOPMENT
& MAINTENANCE**



**AUTOMATIC MECHANICAL
ASSEMBLY**



**PRODUCT DESIGN
& DEVELOPMENT**



PRESENT, WHERE & WHEN you need us

VIRTUAL

Product Configuration

Our Visual Solution Configurator allows you to create custom solutions for your needs in minutes.



Self Service Portal

Our Self Service Portal enables you with the correct information on the status of your orders.

<<< WIDE >>>

Network of Distributors

Our dealers across India and the world, ensure the availability of our products and mitigate any supply chain hindrances.

Present in **80+** Countries

No Matter where your business takes you, you will find Connectwell present to help you with products and solutions

100+

Sales & Product Support Personnel

Our experienced Sales and Marketing Team, Supported by Product Experts are at your disposal to help you arrive at the right solution for your needs.

SOLUTIONS ACROSS INDUSTRIES

Our customers range from the largest to smallest entities across variety of industries.
Here are some interesting case studies.



CONTINUOUS PROCESS AUTOMATION

Safeguarding process against cement dust ingress



POWER

Connectwell's Marshalling Terminal Blocks for the Telangana Super Thermal Power Project

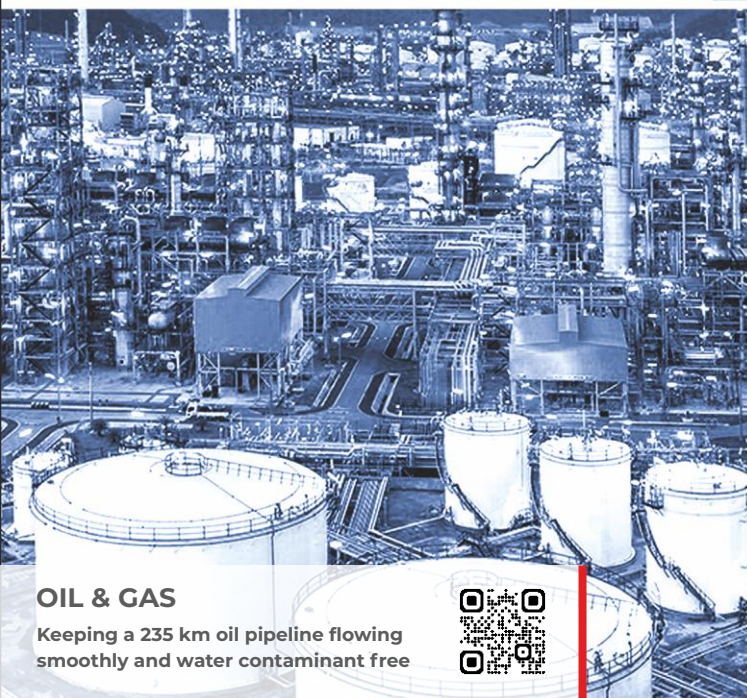

OIL & GAS

Keeping a 235 km oil pipeline flowing smoothly and water contaminant free



MACHINERY & FACTORY AUTOMATION

Empowering Sustainable Mining



BUILDING INFRASTRUCTURE

Connectwell solutions for a German HVAC leader



TRANSPORTATION

Connectwell Terminal Blocks Solve Haramain Railway's Corrosion Problem



[READ MORE CASE STUDIES HERE](#)



CP SERIES PUSH-IN

TERMINAL BLOCKS

CP series Push-In Terminal Blocks have a specialized connection system that enables tool less wire connections. Reliable, vibration resistant, gas tight connections are made with in built high quality stainless steel Push-In spring clamps.

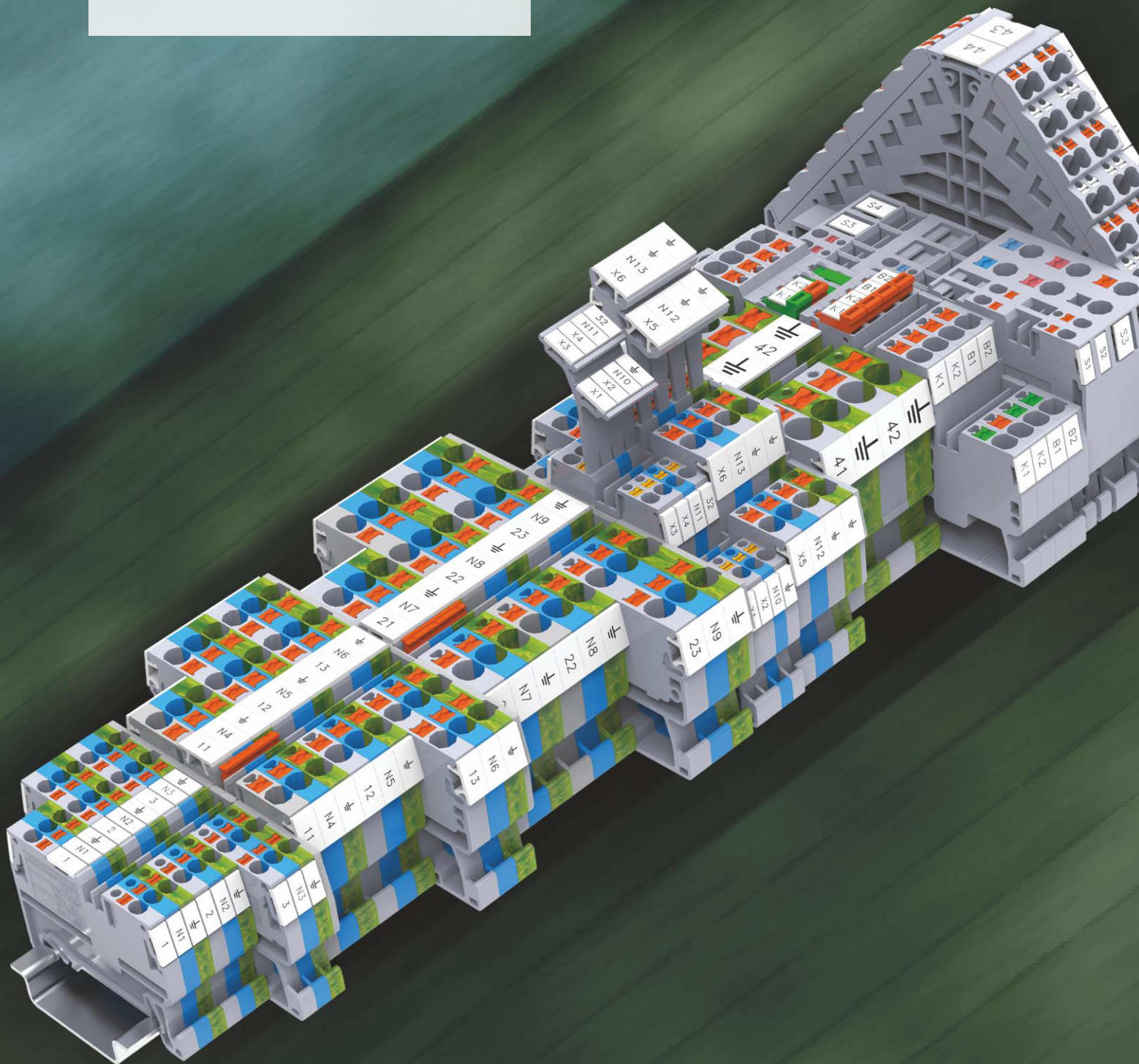

CP SERIES PUSH-IN TERMINAL BLOCKS

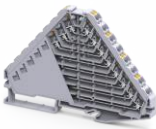
	Feed Through	9 - 10
	Multiple Connection	11 - 14
	Ground / Earth	15 - 19
	Double Level	20 - 25
	Triple Level	26 - 28
	Sensor & Actuator	29 - 31
	Component Carrier	32
	Marshalling	33 - 34
	Fuse	35 - 37
	Disconnect	38 - 42
	With Electronic Components	43 - 45

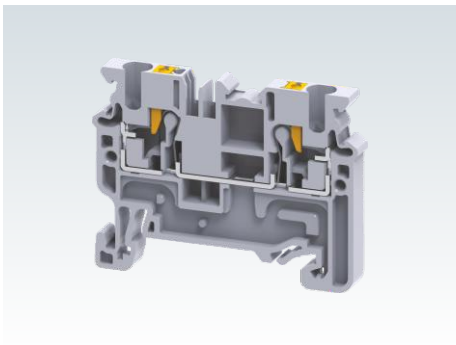

CP series Push-In Terminal Blocks have a specialized connection system that enables tool less wire connections. Reliable, vibration resistant, gas tight connections are made with in built high quality stainless steel Push-In spring clamps.



Solid wires and wires with crimped lugs / ferrules are simply pushed into the connection point. No special tools or screwdrivers are required for making such connections. The connection spring is actuated with minimum insertion force.

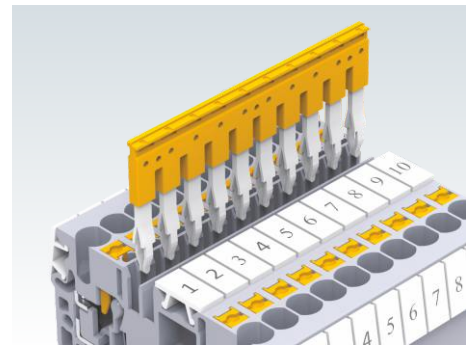

Standardized jumpers for shorting Terminal Blocks are now available in various pole configurations.

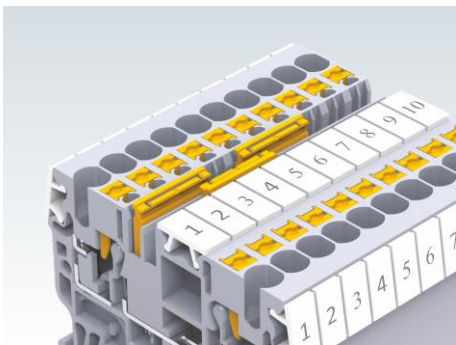

The possibility of using 2 independent rows for jumpering enables the creation of various circuit combinations. Jumpers can be marked with a felt tip pen on the recess provided on top, to clearly indicate shorted positions.

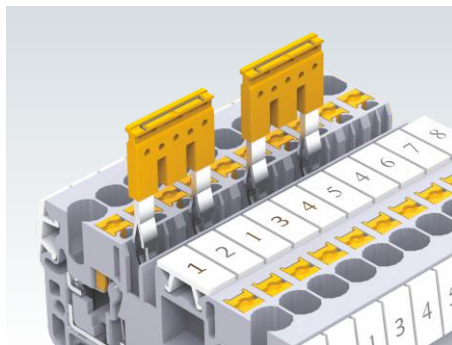

Individual Terminal Blocks in an assembly can be skipped from getting shorted with the adjacent terminal. This is achieved by breaking intermediate contacts from the standard pluggable jumpers.



Step down jumpers facilitate shorting of different wire size terminals. This helps in building distribution circuits easily.

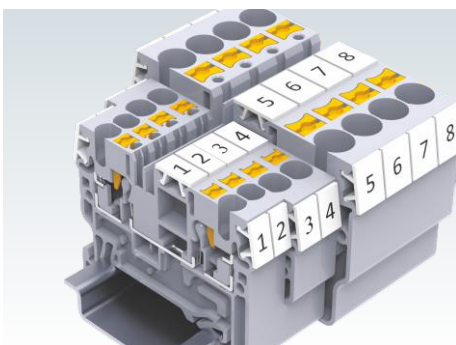

High quality stainless steel Push-In springs, provide a gas tight connection. A vibration proof, anti-loosening wire connection is achieved with this pre-stressed Push-In spring clamp system.



The jumper and marking tag position is aligned across different types of CP series Terminal Blocks. This facilitates shorting and marking adjacent terminals with different functionalities.

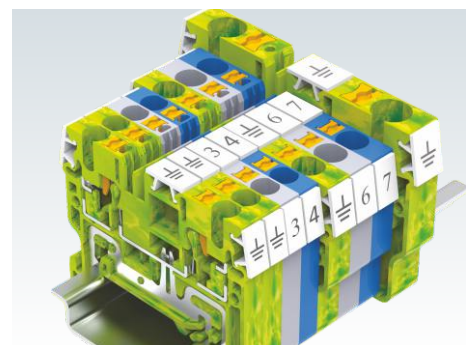

Ground Terminal Blocks have specially designed alloy feet which snap on to the DIN rail. They are green-yellow colour coded as per industry norms.

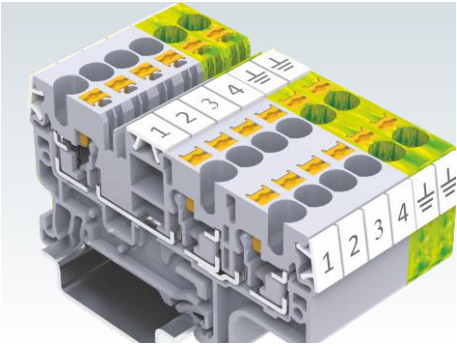

Multi connection Terminal Blocks are used for applications involving more than one same potential wires to be connected.

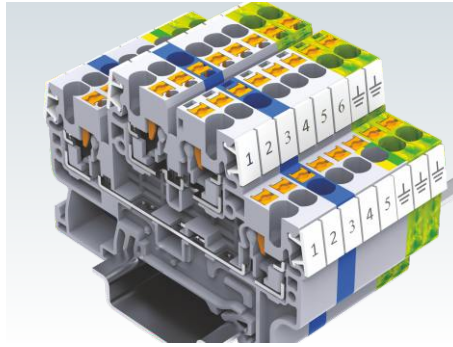

Double level Terminal Blocks enable high density wiring. Each level can be independently shorted to suit various applications.

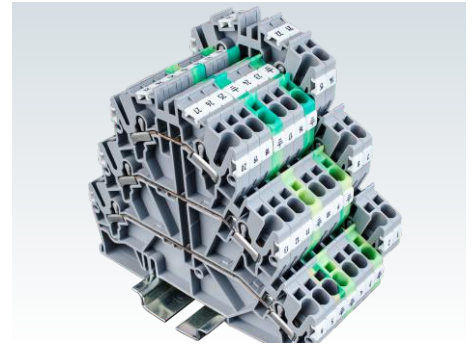

Multi level Terminal Blocks are ideal choice for control systems. Two Level plus ground and three level plus ground terminals facilitate single & three phase connections.

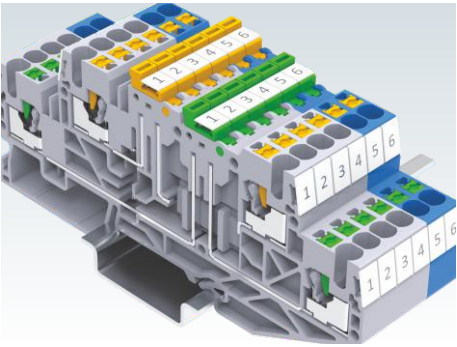

Knife type disconnecting Terminal Blocks are available for applications in process control industries. The circuit on individual levels can be easily disconnected by lifting the disconnection lever.

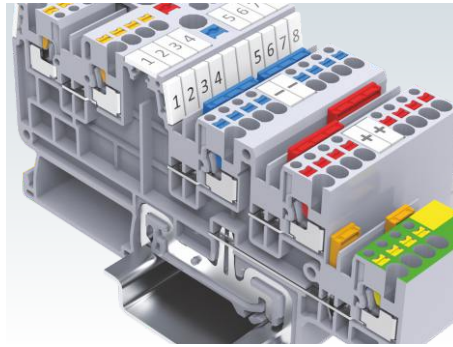

Sensors and actuator Terminal Blocks are ideal for wiring machine control systems. These Terminal Blocks are extremely compact with a terminal thickness of as low as 3.5mm

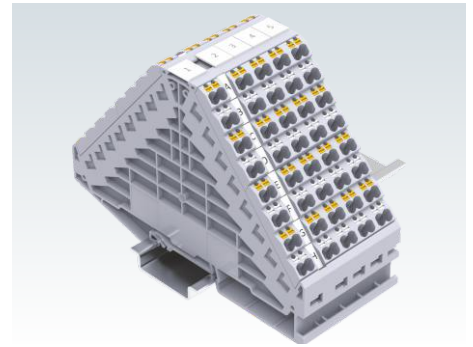

8 Level Terminal Blocks are space saving method for potential and signal distribution. Push-In connection technology facilitates extremely high density wiring. This is an ideal choice for high density marshalling cabinets.



Specially designed Test Plugs are available for CP series Terminal Blocks for quick testing and measurement.

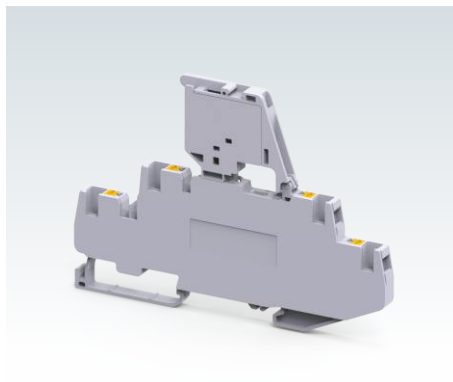

Single & Multilevel Fuse Terminal Blocks have an integral built-in end plate. They are available in various configuration including LED variants for indication fuse blow out.

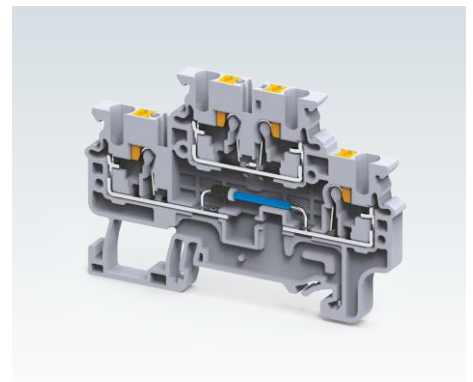

A wide range of functional Terminal Blocks are available with built-in electronic components.

FEED THROUGH TERMINAL BLOCKS

CP series Push-In Terminal Blocks have a specialized connection system that enables tool less wire connections.

Lugged cable & solid wires can be directly pressed into the clamp to make connections.

The Push button on the top is to be pressed for using flexible cable without lug / ferrule for connection.

Cross connection of these Terminal Blocks can be done using pluggable jumpers available in various pole configurations.

The terminals with  & IECEx approval can be used in potentially explosive atmosphere. For detailed information refer page 289.

Width (Thickness) x Length	3.5 x 45.3 mm			
Height with DIN 35 x 7.5 / 35 x 15 mm Rail	34.1 mm / 41.1 mm			
Connection Possibility as per	IEC		UL - CSA	
With 1 Conductor per clamp	Stranded / Flexible	0.2 - 1.5 mm ²	24 - 14 AWG	
	Solid	0.2 - 2.5 mm ²	24 - 14 AWG	
	with Ferrule / Lug	0.2 - 1.0 mm ²	24 - 18 AWG	
With 2 same size Conductors per clamp	with TWIN Ferrule / Lug			
Wire Stripping Length	8 mm			
Ratings As Per	IEC60947-7-1	UL-1059	CSA22.2-158	IEC60079-7
Voltage	800 V	600 V	600 V	630 V
Current	15 A	15 A	15 A	13 A
Approval				
Insulation Material / Material Group	Polyamide 6,6 / 1			
Rated Impulse Voltage / Pollution Degree	8 KV / 3			

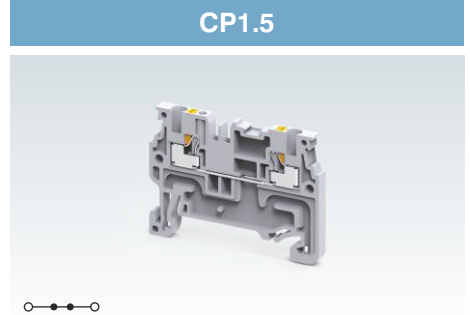

	Type / Cat. No.	Standard Pack	
Terminal Block	Grey	CP1.5	100
	Blue	CP1.5BU	100
	Red	CP1.5R	100
	Yellow	CP1.5Y	100
	Black	CP1.5BK	100
	Green	CP1.5GN	100
	Ground / Earth	CPG1.5 (Refer Pg. 15 for details)	100
End Plate	EPCP1.5	50	
Partition Plate	PPCX4	50	
Mounting Rail (Refer Pg. 263 for details)	CA701-1M / CA701-1M-S	50 m	
	CA701-15-1M / CA701-15-1M-S	25 m	
End Clamp (Refer Pg. 264 for details)	CA103 / CA104	50	
Marking Tags (Refer Pg. 268 for details)	MS3.5WHT	100	
Marker Card (Refer Pg. 269 for details)	MC3.5	10	
Screw Driver	SCM0.4/2	Blade size: 0.4 x 2 mm	10

Jumpers	Type / Cat. No.	I _{max}	Standard Pack	
Pluggable Jumpers	2 pole	JX1.5/2	16 A	100
	3 pole	JX1.5/3	16 A	50
	4 pole	JX1.5/4	16 A	50
	5 pole			
	6 pole			
	7 pole			
	8 pole			
	10 pole	JX1.5/10	16 A	10
	16 pole			
	20 pole			
Step Down Jumpers	6 - 2.5 mm ² 6 - 4 mm ²			
Test Plug				

CP2.5

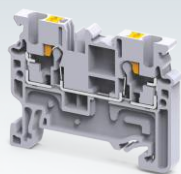

5 x 48.0 mm

38.3 mm / 45.8 mm

IEC	UL - CSA
0.2 - 2.5 mm ²	24 - 12 AWG
0.2 - 4.0 mm ²	24 - 10 AWG
0.2 - 2.5 mm ²	24 - 14 AWG

0.5 mm² 20 AWG

10 mm

IEC60947-7-1 UL-1059 CSA22.2-158 IEC60079-7

1000 V	600 V	600 V	630 V
24 A	20 A	20 A	21 A



Polyamide 6,6 / 1

8 KV / 3

Type / Cat. No.	Standard Pack
CP2.5	100
CP2.5BU	100
CP2.5R	100
CP2.5Y	100
CP2.5BK	100
CP2.5GN	100
CPG2.5 (Refer Pg. 16 for details)	100
EPCX2.5	50
PPCX4	50
CA701-1M / CA701-1M-S	50 m
CA701-15-1M / CA701-15-1M-S	25 m
CA103 / CA104	50
CA509/K5WHT	100
MC5	10
SCM0.5/3 Blade size: 0.5 x 3 mm	10

CP4

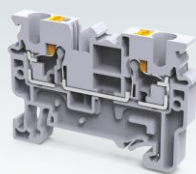

6 x 54.8 mm

38.3 mm / 45.8 mm

IEC	UL - CSA
0.2 - 4.0 mm ²	24 - 10 AWG
0.2 - 6.0 mm ²	24 - 12 AWG
0.2 - 4.0 mm ²	24 - 12 AWG

0.5 - 1.0 mm² 20 - 18 AWG

11 mm

IEC60947-7-1 UL-1059 IEC60079-7

1000 V	600 V	630 V
32 A	30 A	28 A



Polyamide 6,6 / 1

8 KV / 3

Type / Cat. No.	Standard Pack
CP4	100
CP4BU	100
CP4R	100
CP4Y	100
CP4BK	100
CP4GN	100
CPG4 (Refer Pg. 16 for details)	100
EPCX4	50
PPCX4	50
CA701-1M / CA701-1M-S	50 m
CA701-15-1M / CA701-15-1M-S	25 m
CA103 / CA104	50
CA509/K6WHT	100
MC6	10
SCM0.6/3.5 Blade size: 0.6 x 3.5 mm	10

Type / Cat. No.	I _{max}	Standard Pack
JX4/2	32 A	100
JX4/3	32 A	50
JX4/4	32 A	50
JX4/5	32 A	50
JX4/6	32 A	50
JX4/8	32 A	10
JX4/10	32 A	10
JX4/16	32 A	10
JXS6/4	32 A	50

CP6/10

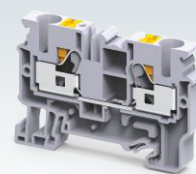

8 x 62.8 mm

43 mm / 50.6 mm

IEC	UL - CSA
0.5 - 10.0 mm ²	20 - 8 AWG
0.5 - 10.0 mm ²	20 - 8 AWG
0.5 - 10.0 mm ²	20 - 8 AWG

0.5 - 2.5 mm² 20 - 14 AWG

12 mm

IEC60947-7-1 UL-1059 CSA22.2-158 IEC60079-7

1000 V	600 V	600 V	630 V
57 A	44 A	44 A	51 A



Polyamide 6,6 / 1

8 KV / 3

Type / Cat. No.	Standard Pack
CP6/10	100
CP6/10BU	100
CP6/10R	100
CP6/10Y	100
CP6/10BK	100
CP6/10GN	100
CPG6/10 (Refer Pg. 16 for details)	100
EPCX6	50
PPCX10	20
CA701-1M / CA701-1M-S	50 m
CA701-15-1M / CA701-15-1M-S	25 m
CA103 / CA104	50
CA509/K8WHT	100
MC8	10
SCM0.8/4 Blade size: 0.8 x 4 mm	10





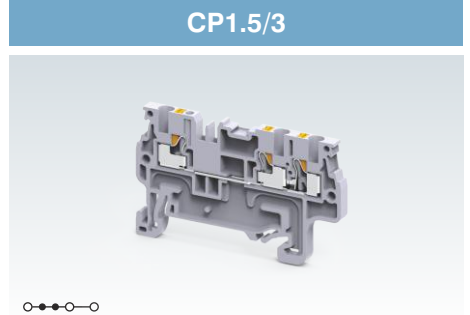

Type / Cat. No.	I _{max}	Standard Pack
JX6/2	41 A	100
JX6/3	41 A	50
JX6/4	41 A	50
JX6/5	41 A	50
JX6/10	41 A	10
JXS6/2.5	24 A	50
JXS6/4	32 A	50

MULTIPLE CONNECTION TERMINAL BLOCKS

CP series multi connect 3 wire & 4 wire Push-In type Terminal Blocks are used to eliminate reliability problems encountered when there is a need to connect multiple wires in a single Terminal Block.

Width (Thickness) x Length	3.5 x 56.1 mm			
Height with DIN 35 x 7.5 / 35 x 15 mm Rail	34.1 mm / 41.1 mm			
Connection Possibility as per	IEC		UL - CSA	
With 1 Conductor per clamp	Stranded / Flexible	0.2 - 1.5 mm ²	24 - 14 AWG	
	Solid	0.2 - 2.5 mm ²	24 - 14 AWG	
	with Ferrule / Lug	0.2 - 1.0 mm ²	24 - 18 AWG	
With 2 same size Conductors per clamp	with TWIN Ferrule / Lug			
Wire Stripping Length	8 mm			
Ratings As Per	IEC60947-7-1	UL-1059	CSA22.2-158	IEC60079-7
Voltage	800 V	600 V	600 V	630 V
Current	15 A	15 A	15 A	13 A
Approval				
Insulation Material / Material Group	Polyamide 6,6 / 1			
Rated Impulse Voltage / Pollution Degree	8 KV / 3			



		Type / Cat. No.	Standard Pack	
Terminal Block	Grey	CP1.5/3	100	
	Blue	CP1.5/3BU	100	
	Red	CP1.5/3R	100	
	Yellow	CP1.5/3Y	100	
	Black	CP1.5/3BK	100	
	Green	CP1.5/3GN	100	
	Ground / Earth	CPG1.5/3 (Refer Pg. 17 for details)	100	
End Plate		EPCP1.5/3	50	
Partition Plate		PPCX4/3	50	
Mounting Rail	(Refer Pg. 263 for details) 	CA701-1M / CA701-1M-S	50 m	
		CA701-15-1M / CA701-15-1M-S	25 m	
End Clamp	(Refer Pg. 264 for details) 	CA103 / CA104	50	
Marking Tags	(Refer Pg. 268 for details) 	MS3.5WHT	100	
Marker Card	(Refer Pg. 269 for details)	MC3.5	10	
Screw Driver		SCM0.4/2	Blade size: 0.4 x 2 mm	10

		Type / Cat. No.	I _{max}	Standard Pack
Pluggable Jumpers	2 pole	JX1.5/2	15 A	100
	3 pole	JX1.5/3	15 A	50
	4 pole	JX1.5/4	15 A	50
	5 pole			
	6 pole			
	7 pole			
	8 pole			
	10 pole	JX1.5/10	15 A	10
	20 pole			
	Step Down Jumpers	6 - 2.5 mm ² 6 - 4 mm ²		
Test Plug				

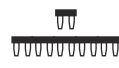

CP1.5/4

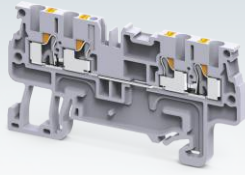

3.5 x 66.9 mm

34.1 mm / 41.1 mm

IEC	UL - CSA
0.2 - 1.5 mm ²	24 - 14 AWG
0.2 - 2.5 mm ²	24 - 14 AWG
0.2 - 1.0 mm ²	24 - 18 AWG

8 mm

IEC60947-7-1 UL-1059 CSA22.2-158 IEC60079-7

800 V	600 V	600 V	630 V
15 A	15 A	15 A	13 A



Polyamide 6,6 / 1

8 KV / 3

Type / Cat. No.	Standard Pack
CP1.5/4	100
CP1.5/4BU	100
CP1.5/4R	100
CP1.5/4Y	100
CP1.5/4BK	100
CP1.5/4GN	100
CPG1.5/4 (Refer Pg. 17 for details)	100
EPCP1.5/4	50
PPCX4/4	50
CA701-1M / CA701-1M-S	50 m
CA701-15-1M / CA701-15-1M-S	25 m
CA103 / CA104	50
MS3.5WHT	100
MC3.5	10
SCM0.4/2 Blade size: 0.4 x 2 mm	10

CP2.5/3

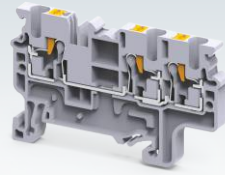

5 x 62.2 mm

38.3 mm / 45.7 mm

IEC	UL - CSA
0.2 - 2.5 mm ²	24 - 12 AWG
0.2 - 4.0 mm ²	24 - 10 AWG
0.2 - 2.5 mm ²	24 - 14 AWG

0.5 mm² 20 AWG

10 mm

IEC60947-7-1 UL-1059 CSA22.2-158 IEC60079-7

1000 V	600 V	600 V	630 V
24 A	20 A	20 A	21 A



Polyamide 6,6 / 1

8 KV / 3

Type / Cat. No.	Standard Pack
CP2.5/3	100
CP2.5/3BU	100
CP2.5/3R	100
CP2.5/3Y	100
CP2.5/3BK	100
CP2.5/3GN	100
CPG2.5/3 (Refer Pg. 18 for details)	100
EPCX2.5/3	50
PPCX4/3	50
CA701-1M / CA701-1M-S	50 m
CA701-15-1M / CA701-15-1M-S	25 m
CA103 / CA104	50
CA509/K5WHT	100
MC5	10
SCM0.5/3 Blade size: 0.5 x 3 mm	10

Type / Cat. No.	I _{max}	Standard Pack
JX2.5/2	24 A	100
JX2.5/3	24 A	50
JX2.5/4	24 A	50
JX2.5/5	24 A	50
JX2.5/6	24 A	10
JX2.5/7	24 A	10
JX2.5/8	24 A	10
JX2.5/10	24 A	10
JX2.5/20	24 A	10
JXS6/2.5	24 A	50
TX2.5		20

CP2.5/4

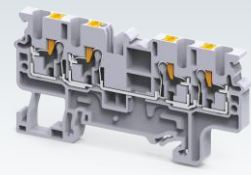

5 x 73 mm

38.3 mm / 45.7 mm

IEC	UL - CSA
0.2 - 2.5 mm ²	24 - 12 AWG
0.2 - 4.0 mm ²	24 - 10 AWG
0.2 - 2.5 mm ²	24 - 14 AWG

0.5 mm² 20 AWG

10 mm

IEC60947-7-1 UL-1059 CSA22.2-158 IEC60079-7

1000 V	600 V	600 V	630 V
24 A	20 A	20 A	21 A

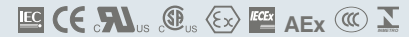

Polyamide 6,6 / 1

8 KV / 3

Type / Cat. No.	Standard Pack
CP2.5/4	100
CP2.5/4BU	100
CP2.5/4R	100
CP2.5/4Y	100
CP2.5/4BK	100
CP2.5/4GN	100
CPG2.5/4 (Refer Pg. 18 for details)	100
EPCX2.5/4	50
PPCX4/4	50
CA701-1M / CA701-1M-S	50 m
CA701-15-1M / CA701-15-1M-S	25 m
CA103 / CA104	50
CA509/K5WHT	100
MC5	10
SCM0.5/3 Blade size: 0.5 x 3 mm	10

Type / Cat. No.	I _{max}	Standard Pack
JX2.5/2	24 A	100
JX2.5/3	24 A	50
JX2.5/4	24 A	50
JX2.5/5	24 A	50
JX2.5/6	24 A	10
JX2.5/7	24 A	10
JX2.5/8	24 A	10
JX2.5/10	24 A	10
JX2.5/20	24 A	10
JXS6/2.5	24 A	50
TX2.5		20

CP4/3

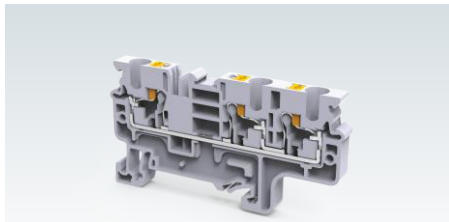

CP4/4

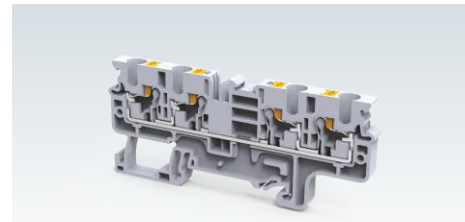

Width (Thickness) x Length	6 x 70.5 mm	
Height with DIN 35 x 7.5 / 35 x 15 mm Rail	38.3 mm / 45.7 mm	
Connection Possibility as per	IEC	UL - CSA
With 1 Conductor per clamp	Stranded / Flexible	0.2 - 4.0 mm ²
	Solid	0.2 - 6.0 mm ²
	with Ferrule / Lug	0.2 - 4.0 mm ²
With 2 same size Conductors per clamp	with TWIN Ferrule / Lug	0.5 - 1.0 mm ²
Wire Stripping Length	10 mm	
Ratings As Per	IEC60947-7-1	UL-1059 IEC60079-7
Voltage	1000 V	600 V 630 V
Current	32 A	30 A 28 A
Approval		
Insulation Material / Material Group	Polyamide 6,6 / 1	
Rated Impulse Voltage / Pollution Degree	8 KV / 3	

Width (Thickness) x Length	6 x 86.2 mm	
Height with DIN 35 x 7.5 / 35 x 15 mm Rail	38.3 mm / 45.7 mm	
Connection Possibility as per	IEC	UL - CSA
With 1 Conductor per clamp	Stranded / Flexible	0.2 - 4.0 mm ²
	Solid	0.2 - 6.0 mm ²
	with Ferrule / Lug	0.2 - 4.0 mm ²
With 2 same size Conductors per clamp	with TWIN Ferrule / Lug	0.5 - 1.0 mm ²
Wire Stripping Length	10 mm	
Ratings As Per	IEC60947-7-1	UL-1059 IEC60079-7
Voltage	1000 V	600 V 630 V
Current	32 A	30 A 28 A
Approval		
Insulation Material / Material Group	Polyamide 6,6 / 1	
Rated Impulse Voltage / Pollution Degree	8 KV / 3	

	Type / Cat. No.	Standard Pack
Terminal Block	Grey	CP4/3
	Blue	CP4/3BU
	Red	CP4/3R
	Yellow	CP4/3Y
	Black	CP4/3BK
	Green	CP4/3GN
	Ground / Earth	CPG4/3 (Refer Pg. 18 for details)
	End Plate	EPCX4/3
Partition Plate	PPCX4/3	
Mounting Rail (Refer Pg. 263 for details)	CA701-1M / CA701-1M-S	50 m
	CA701-15-1M / CA701-15-1M-S	25 m
End Clamp (Refer Pg. 264 for details)	CA103 / CA104	50
Marking Tags (Refer Pg. 268 for details)	CA509/K6WHT	100
Marker Card (Refer Pg. 269 for details)	MC6	10
Screw Driver	SCM0.6/3.5 Blade size: 0.6 x 3.5 mm	10

	Type / Cat. No.	Standard Pack
Terminal Block	Grey	CP4/4
	Blue	CP4/4BU
	Red	CP4/4R
	Yellow	CP4/4Y
	Black	CP4/4BK
	Green	CP4/4GN
	Ground / Earth	CPG4/4 (Refer Pg. 19 for details)
	End Plate	EPCX4/4
Partition Plate	PPCX4/4	
Mounting Rail (Refer Pg. 263 for details)	CA701-1M / CA701-1M-S	50 m
	CA701-15-1M / CA701-15-1M-S	25 m
End Clamp (Refer Pg. 264 for details)	CA103 / CA104	50
Marking Tags (Refer Pg. 268 for details)	CA509/K6WHT	100
Marker Card (Refer Pg. 269 for details)	MC6	10
Screw Driver	SCM0.6/3.5 Blade size: 0.6 x 3.5 mm	10

	Type / Cat. No.	Standard Pack
Terminal Block	Grey	CP4/3
	Blue	CP4/3BU
	Red	CP4/3R
	Yellow	CP4/3Y
	Black	CP4/3BK
	Green	CP4/3GN
	Ground / Earth	CPG4/3 (Refer Pg. 18 for details)
	End Plate	EPCX4/3
Partition Plate	PPCX4/3	
Mounting Rail (Refer Pg. 263 for details)	CA701-1M / CA701-1M-S	50 m
	CA701-15-1M / CA701-15-1M-S	25 m
End Clamp (Refer Pg. 264 for details)	CA103 / CA104	50
Marking Tags (Refer Pg. 268 for details)	CA509/K6WHT	100
Marker Card (Refer Pg. 269 for details)	MC6	10
Screw Driver	SCM0.6/3.5 Blade size: 0.6 x 3.5 mm	10

	Type / Cat. No.	I _{max}	Standard Pack
Pluggable Jumpers	2 pole	JX4/2	32 A 100
	3 pole	JX4/3	32 A 50
	4 pole	JX4/4	32 A 50
	5 pole	JX4/5	32 A 50
	6 pole	JX4/6	32 A 50
	7 pole	JX4/7	32 A 10
	8 pole	JX4/8	32 A 10
	10 pole	JX4/10	32 A 10
Step Down Jumpers	6 - 2.5 mm ²	JXS6/4	32 A 50
	6 - 4 mm ²	JXS6/4	32 A 50

	Type / Cat. No.	I _{max}	Standard Pack
Pluggable Jumpers	2 pole	JX4/2	32 A 100
	3 pole	JX4/3	32 A 50
	4 pole	JX4/4	32 A 50
	5 pole	JX4/5	32 A 50
	6 pole	JX4/6	32 A 50
	7 pole	JX4/7	32 A 10
	8 pole	JX4/8	32 A 10
	10 pole	JX4/10	32 A 10
Step Down Jumpers	6 - 2.5 mm ²	JXS6/4	32 A 50
	6 - 4 mm ²	JXS6/4	32 A 50

	Type / Cat. No.	I _{max}	Standard Pack
Pluggable Jumpers	2 pole	JX4/2	32 A 100
	3 pole	JX4/3	32 A 50
	4 pole	JX4/4	32 A 50
	5 pole	JX4/5	32 A 50
	6 pole	JX4/6	32 A 50
	7 pole	JX4/7	32 A 10
	8 pole	JX4/8	32 A 10
	10 pole	JX4/10	32 A 10
Step Down Jumpers	6 - 2.5 mm ²	JXS6/4	32 A 50
	6 - 4 mm ²	JXS6/4	32 A 50

CP6/10/3

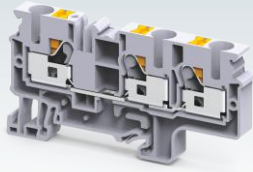

8 x 82.8 mm

43 mm / 50.6 mm

IEC	UL - CSA
0.5 - 10.0 mm ²	20 - 8 AWG
0.5 - 10.0 mm ²	
0.5 - 10.0 mm ²	20 - 8 AWG

0.5 - 2.5 mm² 20 - 14 AWG

12 mm

IEC60947-7-1 UL-1059 CSA22.2-158 IEC60079-7

1000 V	600 V	600 V	630 V
57 A	44 A	44 A	51 A

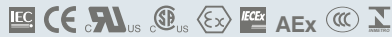

Polyamide 6,6 / 1

8 KV / 3

Type / Cat. No.	Standard Pack
CP6/10/3	50
CP6/10/3BU	50
CP6/10/3R	50
CP6/10/3Y	50
CP6/10/3BK	50
CP6/10/3GN	50
CPG6/10/3 (Refer Pg. 19 for details)	50
EPCX6/3	50
CA701-1M / CA701-1M-S	50 m
CA701-15-1M / CA701-15-1M-S	25 m
CA103 / CA104	50
CA509/K8WHT	100
MC8	10
SCM0.8/4 Blade size: 0.8 x 4 mm	10

Type / Cat. No.	I _{max}	Standard Pack
JX6/2	41 A	100
JX6/3	41 A	50
JX6/4	41 A	50
JX6/5	41 A	50
JX6/10	41 A	10
JXS6/2.5	24 A	50
JXS6/4	32 A	50

CPG2.5

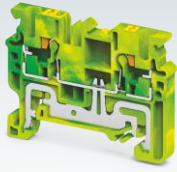

5 x 49.7 mm
38.3 mm / 45.8 mm

IEC	UL - CSA
0.2 - 2.5 mm ²	24 - 12 AWG
0.2 - 4.0 mm ²	24 - 10 AWG
0.2 - 2.5 mm ²	24 - 14 AWG

0.5 mm² 20 AWG

10 mm



Polyamide 6,6 / 1

8 KV / 3

Type / Cat. No.	Standard Pack
CPG2.5	100
EPCX2.5	50
PPCX4	50
CA701-1M / CA701-1M-S	50 m
CA701-15-1M / CA701-15-1M-S	25 m
CA103 / CA104	50
CA509/K5WHT	100
MC5	10
SCM0.5/3 Blade size: 0.5 x 3 mm	10

Type / Cat. No.	Imax	Standard Pack
JX2.5/2	24 A	100
JX2.5/3	24 A	50
JX2.5/4	24 A	50
JX2.5/5	24 A	50
JX2.5/6	24 A	10
JX2.5/7	24 A	10
JX2.5/8	24 A	10
JX2.5/10	24 A	10
JX2.5/20	24 A	10
JXS6/2.5	24 A	50
TX2.5		20

CPG4

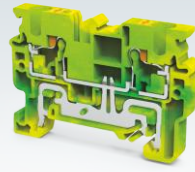

6 x 54.8 mm
38.3 mm / 45.8 mm

IEC	UL - CSA
0.2 - 4.0 mm ²	24 - 10 AWG
0.2 - 6.0 mm ²	
0.2 - 4.0 mm ²	24 - 12 AWG

0.5 - 1.0 mm² 20 - 18 AWG

11 mm



Polyamide 6,6 / 1

8 KV / 3

Type / Cat. No.	Standard Pack
CPG4	100
EPCX4	50
PPCX4	50
CA701-1M / CA701-1M-S	50 m
CA701-15-1M / CA701-15-1M-S	25 m
CA103 / CA104	50
CA509/K6WHT	100
MC6	10
SCM0.5/3 Blade size: 0.5 x 3 mm	10

Type / Cat. No.	Imax	Standard Pack
JX4/2	32 A	100
JX4/3	32 A	50
JX4/4	32 A	50
JX4/5	32 A	50
JX4/6	32 A	50
JX4/8	32 A	10
JX4/10	32 A	10
JX4/16	32 A	10
JXS6/4	32 A	50

CPG6/10

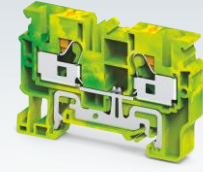

8 x 62.8 mm
43 mm / 50.6 mm

IEC	UL - CSA
0.5 - 10.0 mm ²	20 - 8 AWG
0.5 - 10.0 mm ²	
0.5 - 10.0 mm ²	20 - 8 AWG

0.5 - 2.5 mm² 20 - 14 AWG

12 mm



Polyamide 6,6 / 1

8 KV / 3

Type / Cat. No.	Standard Pack
CPG6/10	100
EPCX6	50
PPCX10	20
CA701-1M / CA701-1M-S	50 m
CA701-15-1M / CA701-15-1M-S	25 m
CA103 / CA104	50
CA509/K8WHT	100
MC8	10
SCM0.8/4 Blade size: 0.8 x 4 mm	10

Type / Cat. No.	Imax	Standard Pack
JX6/2	41 A	100
JX6/3	41 A	50
JX6/4	41 A	50
JX6/10	41 A	10
JXS6/2.5	24 A	50
JXS6/4	32 A	50

CPG1.5/3

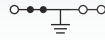
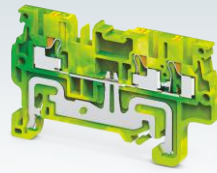

CPG1.5/4

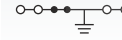
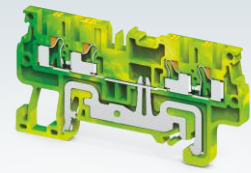

Width (Thickness) x Length	3.5 x 54.5 mm			3.5 x 63.5 mm			
Height with DIN 35 x 7.5 / 35 x 15 mm Rail	32.8 mm / 40.3 mm			32.8 mm / 40.3 mm			
Connection Possibility as per	With 1 Conductor per clamp	Stranded / Flexible	IEC	UL - CSA	IEC	UL - CSA	
		Solid	0.2 - 1.5 mm ²	24 - 14 AWG	0.2 - 1.5 mm ²	24 - 14 AWG	
	With 2 same size Conductors per clamp	with Ferrule / Lug	0.2 - 2.5 mm ²	24 - 14 AWG	0.2 - 2.5 mm ²	24 - 14 AWG	
		with TWIN Ferrule / Lug	0.2 - 1.0 mm ²	24 - 18 AWG	0.2 - 1.0 mm ²	24 - 18 AWG	
Wire Stripping Length	8 mm			8 mm			
Approval							
Insulation Material / Material Group	Polyamide 6,6 / 1			Polyamide 6,6 / 1			
Rated Impulse Voltage / Pollution Degree	8 KV / 3			8 KV / 3			
	Type / Cat. No.		Standard Pack	Type / Cat. No.		Standard Pack	
Terminal Block	CPG1.5/3		50	CPG1.5/4		50	
End Plate	EPCP1.5/3		50	EPCP1.5/4		50	
Partition Plate	PPCX4/3		50	PPCX4/4		50	
Mounting Rail (Refer Pg. 263 for details)	CA701-1M / CA701-1M-S		50 m	CA701-1M / CA701-1M-S		50 m	
	CA701-15-1M / CA701-15-1M-S		25 m	CA701-15-1M / CA701-15-1M-S		25 m	
End Clamp (Refer Pg. 264 for details)	CA103 / CA104		50	CA103 / CA104		50	
Marking Tags (Refer Pg. 268 for details)	MS3.5WHT		100	MS3.5WHT		100	
Marker Card (Refer Pg. 269 for details)	MC3.5		10	MC3.5		10	
Screw Driver	SCM0.4/2 Blade size: 0.4 x 2 mm		10	SCM0.4/2 Blade size: 0.4 x 2 mm		10	
	Type / Cat. No.		I_{max}	Standard Pack	Type / Cat. No.		
Pluggable Jumpers	2 pole	JX1.5/2	15 A	100	JX1.5/2	15 A	100
	3 pole	JX1.5/3	15 A	50	JX1.5/3	15 A	50
	4 pole	JX1.5/4	15 A	50	JX1.5/4	15 A	50
	5 pole						
	6 pole						
	7 pole						
	8 pole						
	10 pole	JX1.5/10	15 A	10	JX1.5/10	15 A	10
	16 pole						
	20 pole						
Step Down Jumpers	6 - 2.5 mm ²						
	6 - 4 mm ²						
Test Plug							

CPG2.5/3

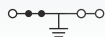
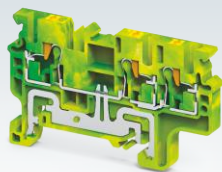

5 x 62.5 mm

38.3 mm / 45.8 mm

IEC	UL - CSA
0.2 - 2.5 mm ²	24 - 12 AWG
0.2 - 4.0 mm ²	24 - 10 AWG
0.2 - 2.5 mm ²	24 - 14 AWG

0.5 mm² 20 AWG

10 mm



Polyamide 6,6 / 1

8 KV / 3

Type / Cat. No.	Standard Pack
CPG2.5/3	100
EPCX2.5/3	50
PPCX4/3	50
CA701-1M / CA701-1M-S	50 m
CA701-15-1M / CA701-15-1M-S	25 m
CA103 / CA104	50
CA509/K5WHT	100
MC5	10
SCM0.5/3 Blade size: 0.5 x 3 mm	10

Type / Cat. No.	I _{max}	Standard Pack
JX2.5/2	24 A	100
JX2.5/3	24 A	50
JX2.5/4	24 A	50
JX2.5/5	24 A	50
JX2.5/6	24 A	10
JX2.5/7	24 A	10
JX2.5/8	24 A	10
JX2.5/10	24 A	10
JX2.5/20	24 A	10
JXS6/2.5	24 A	50
TX2.5		20

CPG2.5/4

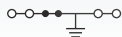
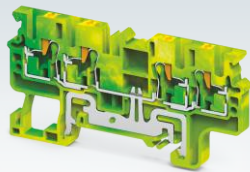

5 x 73 mm

38.3 mm / 45.8 mm

IEC	UL - CSA
0.2 - 2.5 mm ²	24 - 12 AWG
0.2 - 4.0 mm ²	24 - 10 AWG
0.2 - 2.5 mm ²	24 - 14 AWG

0.5 mm² 20 AWG

10 mm



Polyamide 6,6 / 1

8 KV / 3

Type / Cat. No.	Standard Pack
CPG2.5/4	100
EPCX2.5/4	50
PPCX4/4	50
CA701-1M / CA701-1M-S	50 m
CA701-15-1M / CA701-15-1M-S	25 m
CA103 / CA104	50
CA509/K5WHT	100
MC5	10
SCM0.5/3 Blade size: 0.5 x 3 mm	10

Type / Cat. No.	I _{max}	Standard Pack
JX2.5/2	24 A	100
JX2.5/3	24 A	50
JX2.5/4	24 A	50
JX2.5/5	24 A	50
JX2.5/6	24 A	10
JX2.5/7	24 A	10
JX2.5/8	24 A	10
JX2.5/10	24 A	10
JX2.5/20	24 A	10
JXS6/2.5	24 A	50
TX2.5		20

CPG4/3

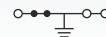
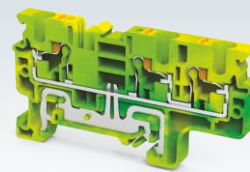

6 x 70.5 mm

38.3 mm / 45.8 mm

IEC	UL - CSA
0.2 - 4.0 mm ²	24 - 10 AWG
0.2 - 6.0 mm ²	
0.2 - 4.0 mm ²	24 - 12 AWG

0.5 - 1.0 mm² 20 - 18 AWG

10 mm



Polyamide 6,6 / 1

8 KV / 3

Type / Cat. No.	Standard Pack
CPG4/3	50
EPCX4/3	50
PPCX4/3	50
CA701-1M / CA701-1M-S	50 m
CA701-15-1M / CA701-15-1M-S	25 m
CA103 / CA104	50
CA509/K6WHT	100
MC6	10
SCM0.6/3.5 Blade size: 0.6 x 3.5 mm	10

Type / Cat. No.	I _{max}	Standard Pack
JX4/2	32 A	100
JX4/3	32 A	50
JX4/4	32 A	50
JX4/5	32 A	50
JX4/6	32 A	50
JX4/8	32 A	10
JX4/10	32 A	10
JX4/16	32 A	10
JXS6/4	32 A	50

CPG4/4

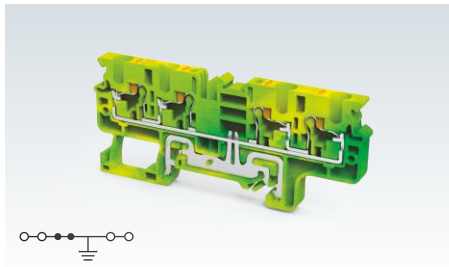

CPG6/10/3

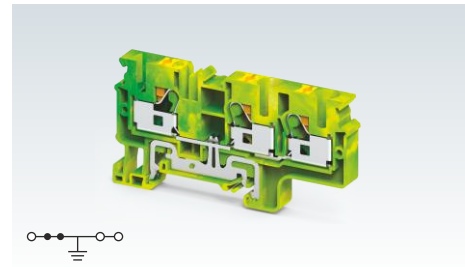

Width (Thickness) x Length		6 x 86.2 mm
Height with DIN 35 x 7.5 / 35 x 15 mm Rail		38.3 mm / 45.8 mm
Connection Possibility as per		
With 1 Conductor per clamp	Stranded / Flexible	0.2 - 4.0 mm ²
	Solid with Ferrule / Lug	0.2 - 6.0 mm ²
With 2 same size Conductors per clamp	with TWIN Ferrule / Lug	0.2 - 4.0 mm ²
Wire Stripping Length		10 mm
Approval		IEC CE G US
Insulation Material / Material Group		Polyamide 6,6 / 1
Rated Impulse Voltage / Pollution Degree		8 KV / 3

IEC	UL - CSA
0.2 - 4.0 mm ²	24 - 10 AWG
0.2 - 6.0 mm ²	24 - 10 AWG
0.2 - 4.0 mm ²	24 - 10 AWG
0.5 - 1.0 mm ²	20 - 18 AWG

IEC	UL - CSA
0.5 - 10.0 mm ²	20 - 8 AWG
0.5 - 10.0 mm ²	20 - 8 AWG
0.5 - 10.0 mm ²	20 - 8 AWG
0.5 - 2.5 mm ²	20 - 14 AWG

Terminal Block	CPG4/4	50
End Plate	EPCX4/4	50
Partition Plate	PPCX4/4	50
Mounting Rail (Refer Pg. 263 for details)	CA701-1M / CA701-1M-S	50 m
	CA701-15-1M / CA701-15-1M-S	25 m
End Clamp (Refer Pg. 264 for details)	CA103 / CA104	50
Marking Tags (Refer Pg. 268 for details)	CA509/K6WHT	100
Marker Card (Refer Pg. 269 for details)	MC6	10
Screw Driver	SCM0.6/3.5 Blade size: 0.6 x 3.5 mm	10

Type / Cat. No.	Standard Pack
CPG4/4	50
EPCX4/4	50
PPCX4/4	50
CA701-1M / CA701-1M-S	50 m
CA701-15-1M / CA701-15-1M-S	25 m
CA103 / CA104	50
CA509/K6WHT	100
MC6	10
SCM0.6/3.5 Blade size: 0.6 x 3.5 mm	10

Type / Cat. No.	Standard Pack
CPG6/10/3	50
EPCX6/3	50
CA701-1M / CA701-1M-S	50 m
CA701-15-1M / CA701-15-1M-S	25 m
CA103 / CA104	50
CA509/K8WHT	100
MC8	10
SCM0.8/4 Blade size: 0.8 x 4 mm	10

Jumpers	Type / Cat. No.	I _{max}	Standard Pack	
Pluggable Jumpers	2 pole	JX4/2	32 A	100
	3 pole	JX4/3	32 A	50
	4 pole	JX4/4	32 A	50
	5 pole	JX4/5	32 A	50
	6 pole	JX4/6	32 A	50
	7 pole			
	8 pole	JX4/8	32 A	10
Step Down Jumpers	10 pole	JX4/10	32 A	10
	16 pole	JX4/16	32 A	10
	6 - 2.5 mm ² 6 - 4 mm ²	JXS6/4	32 A	50
Test Plug				

Type / Cat. No.	I _{max}	Standard Pack
JX4/2	32 A	100
JX4/3	32 A	50
JX4/4	32 A	50
JX4/5	32 A	50
JX4/6	32 A	50
JX4/8	32 A	10
JX4/10	32 A	10
JX4/16	32 A	10
JXS6/4	32 A	50

Type / Cat. No.	I _{max}	Standard Pack
JX6/2	41 A	100
JX6/3	41 A	50
JX6/4	41 A	50
JX6/5	41 A	50
JX6/10	41 A	10
JXS6/4	32 A	50

DOUBLE LEVEL TERMINAL BLOCKS

CPDL1.5, CPDL2.5 & CPDL4 are compact double level Push-In type Terminal Block. These Terminal Blocks are used in high density wiring applications. Interconnections / jumpering is possible at both levels.

CPDL1.5(I.S), CPDL2.5(I.S) & CPDL4(I.S) are double level internally shorted Terminal Blocks. These are ideal choice for distribution application.





CPDLG1.5, CPDLG2.5 & CPDLG4 are double level Push-In Terminal Blocks with an additional grounding point for terminating grounding cables on the lower level of the terminal block. The earth connection is made by snapping the terminal on the Din rail. This separate connection point is appropriately identified by the green-yellow imprint on its top.

CPDLG1.5(I.S), CPDLG2.5(I.S) & CPDLG4(I.S) are double level ground Terminal Blocks with 4 connection points for grounding wires. It is available in a standard green-yellow colour to indicate the grounding connection.

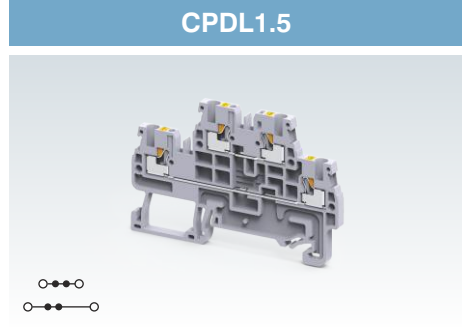
The terminals with  & IECEx approval can be used in potentially explosive atmosphere. For detailed information refer page 289.

Width (Thickness) x Length		3.5 x 67.2 mm	
Height with DIN 35 x 7.5 / 35 x 15 mm Rail		45.3 mm / 52.3 mm	
Connection Possibility as per		IEC	UL - CSA
With 1 Conductor per clamp	Stranded / Flexible	0.2 - 1.5 mm ²	24 - 14 AWG
	Solid with Ferrule / Lug	0.2 - 2.5 mm ²	24 - 14 AWG
With 2 same size Conductors per clamp	with TWIN Ferrule / Lug	0.2 - 1.0 mm ²	24 - 18 AWG
Wire Stripping Length		8 mm	
Ratings As Per		IEC60947-7-1 UL-1059 CSA22.2-158 IEC60079-7	
Voltage		500 V	300 V
Current		16 A	15 A
Approval		15 A	13 A
Insulation Material / Material Group			
Rated Impulse Voltage / Pollution Degree		Polyamide 6,6 / 1 8 KV / 3	



Terminal Block	<ul style="list-style-type: none"> Grey Blue Red Yellow Black Green Ground / Earth
End Plate	
Mounting Rail (Refer Pg. 263 for details)	
End Clamp (Refer Pg. 264 for details)	
Marking Tags (Refer Pg. 268 for details)	
Marker Card (Refer Pg. 269 for details)	
Tree Marker	
Screw Driver	

Type / Cat. No.	Standard Pack
CPDL1.5	100
CPDL1.5BU	100
CPDL1.5R	100
CPDL1.5Y	100
CPDL1.5BK	100
CPDL1.5GN	100
CPDLG1.5 (Refer Pg. 21 for details)	100
EPCPDL1.5	50
CA701-1M / CA701-1M-S	50 m
CA701-15-1M / CA701-15-1M-S	25 m
CA103 / CA104	50
MS3.5WHT	100
MC3.5	10
TM3.5	50
SCM0.4/2	Blade size: 0.4 x 2 mm 10

Jumpers	Type / Cat. No.	I _{max}	Standard Pack
 Pluggable Jumpers	2 pole	JX1.5/2	15 A
	3 pole	JX1.5/3	15 A
	4 pole	JX1.5/4	15 A
	5 pole		
	6 pole		
	7 pole		
	8 pole		
	10 pole	JX1.5/10	15 A

Type / Cat. No.	I _{max}	Standard Pack
JX1.5/2	15 A	100
JX1.5/3	15 A	50
JX1.5/4	15 A	50
JX1.5/10	15 A	10

DOUBLE LEVEL TERMINAL BLOCKS

CPDL1.5(I.S)

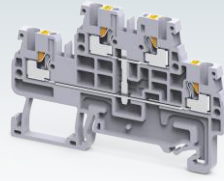

CPDLG1.5

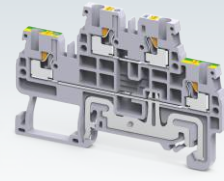

Width (Thickness) x Length	3.5 x 67.2 mm	
Height with DIN 35 x 7.5 / 35 x 15 mm Rail	45.3 mm / 52.3 mm	
Connection Possibility as per	IEC	UL - CSA
With 1 Conductor per clamp	Stranded / Flexible	0.2 - 1.5 mm ²
	Solid	0.2 - 2.5 mm ²
	with Ferrule / Lug	0.2 - 1.0 mm ²
With 2 same size Conductors per clamp	with TWIN Ferrule / Lug	
Wire Stripping Length	8 mm	
Ratings As Per	IEC60947-7-1	UL-1059 CSA22.2-158 IEC60079-7
Voltage	500 V	300 V 300 V 630 V
Current	16 A	15 A 15 A 13 A
Approval		
Insulation Material / Material Group	Polyamide 6,6 / 1	
Rated Impulse Voltage / Pollution Degree	8 KV / 3	

Width (Thickness) x Length	3.5 x 67.2 mm	
Height with DIN 35 x 7.5 / 35 x 15 mm Rail	45.3 mm / 52.3 mm	
Connection Possibility as per	IEC	UL - CSA
With 1 Conductor per clamp	Stranded / Flexible	0.2 - 1.5 mm ²
	Solid	0.2 - 2.5 mm ²
	with Ferrule / Lug	0.2 - 1.0 mm ²
With 2 same size Conductors per clamp	with TWIN Ferrule / Lug	
Wire Stripping Length	8 mm	
Ratings As Per	IEC60947-7-1	UL-1059 CSA22.2-158
Voltage	500 V	300 V 300 V
Current	16 A	15 A 15 A
Approval		
Insulation Material / Material Group	Polyamide 6,6 / 1	
Rated Impulse Voltage / Pollution Degree	8 KV / 3	

	Type / Cat. No.	Standard Pack
Terminal Block	Grey	CPDL1.5(I.S)
	Blue	
	Red	
	Yellow	
	Black	
	Green	
Ground / Earth		
End Plate	EPCPDL1.5	50
Mounting Rail (Refer Pg. 263 for details)	CA701-1M / CA701-1M-S	50 m
	CA701-15-1M / CA701-15-1M-S	25 m
End Clamp (Refer Pg. 264 for details)	CA103 / CA104	50
Marking Tags (Refer Pg. 268 for details)	MS3.5WHT	100
Marker Card (Refer Pg. 269 for details)	MC3.5	10
Dual Marker Carrier	TM3.5	50
Screw Driver	SCM0.4/2 Blade size: 0.4 x 2 mm	10

	Type / Cat. No.	Standard Pack
Terminal Block	CPDLG1.5	50
End Plate	EPCPDL1.5	50
Mounting Rail (Refer Pg. 263 for details)	CA701-1M / CA701-1M-S	50 m
	CA701-15-1M / CA701-15-1M-S	25 m
End Clamp (Refer Pg. 264 for details)	CA103 / CA104	50
Marking Tags (Refer Pg. 268 for details)	MS3.5WHT	100
Marker Card (Refer Pg. 269 for details)	MC3.5	10
Dual Marker Carrier	TM3.5	50
Screw Driver	SCM0.4/2 Blade size: 0.4 x 2 mm	10

Jumpers	Type / Cat. No.	I _{max}	Standard Pack	
Pluggable Jumpers	2 pole	15 A	100	
	3 pole	15 A	50	
	4 pole	15 A	50	
	5 pole			
	6 pole			
	7 pole			
	8 pole			
	10 pole	JX1.5/10	15 A	10
	20 pole			
	Test Plug			

Jumpers	Type / Cat. No.	I _{max}	Standard Pack	
Pluggable Jumpers	2 pole	15 A	100	
	3 pole	15 A	50	
	4 pole	15 A	50	
	5 pole			
	6 pole			
	7 pole			
	8 pole			
	10 pole	JX1.5/10	15 A	10
	20 pole			
	Test Plug			

CPDLG1.5(I.S)

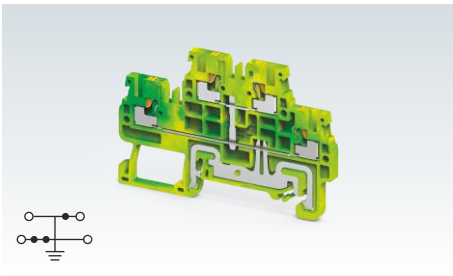

3.5 x 67.2 mm

45.3 mm / 52.3 mm

IEC	UL - CSA
0.2 - 1.5 mm ²	24 - 14 AWG
0.2 - 2.5 mm ²	24 - 14 AWG
0.2 - 1.0 mm ²	24 - 18 AWG

8 mm

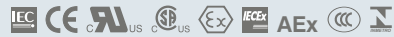

Polyamide 6,6 / 1

8 KV / 3

Type / Cat. No.	Standard Pack
CPDLG1.5(I.S)	50
EPCPDL1.5	50
CA701-1M / CA701-1M-S	50 m
CA701-15-1M / CA701-15-1M-S	25 m
CA103 / CA104	50
MS3.5WHT	100
MC3.5	10
TM3.5	50
SCM0.4/2 Blade size: 0.4 x 2 mm	10

Type / Cat. No.	I _{max}	Standard Pack
JX1.5/2	15 A	100
JX1.5/3	15 A	50
JX1.5/4	15 A	50
JX1.5/10	15 A	10

CPDL2.5

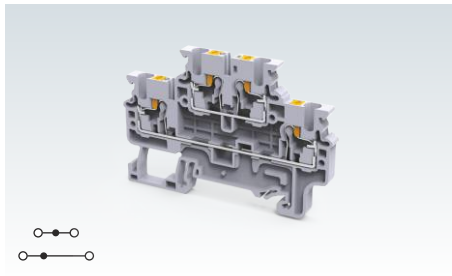

5 x 72.7 mm

49.6 mm / 57 mm

IEC	UL - CSA
0.2 - 2.5 mm ²	24 - 12 AWG
0.2 - 4.0 mm ²	24 - 10 AWG
0.2 - 2.5 mm ²	24 - 14 AWG

0.5 mm² 20 AWG

10 mm

IEC60947-7-1 UL-1059 IEC60079-7

1000 V	600 V	630 V
24 A	20 A	21 A



Polyamide 6,6 / 1

8 KV / 3

Type / Cat. No.	Standard Pack
CPDL2.5	50
CPDL2.5BU	50
CPDL2.5R	50
CPDL2.5Y	50
CPDL2.5BK	50
CPDL2.5GN	50
CPDLG2.5(I.S.) (Refer Pg. 23 for details)	50
EPCXDL2.5	50
CA701-1M / CA701-1M-S	50 m
CA701-15-1M / CA701-15-1M-S	25 m
CA103 / CA104	50
CA509/K5WHT	100
MC5	10
TM5	50
SCM0.5/3 Blade size: 0.5 x 3 mm	10

Type / Cat. No.	I _{max}	Standard Pack
JX2.5/2	24 A	100
JX2.5/3	24 A	50
JX2.5/4	24 A	50
JX2.5/5	24 A	50
JX2.5/6	24 A	10
JX2.5/7	24 A	10
JX2.5/8	24 A	10
JX2.5/10	24 A	10
JX2.5/20	24 A	10
TX2.5		20

CPDL2.5(I.S)

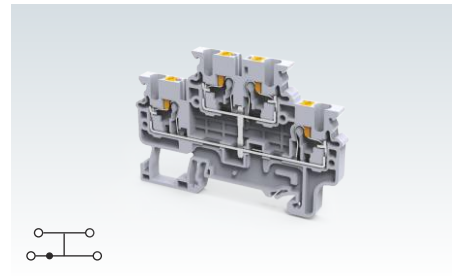

5 x 72.7 mm

49.6 mm / 57 mm

IEC	UL - CSA
0.2 - 2.5 mm ²	24 - 12 AWG
0.2 - 4.0 mm ²	24 - 10 AWG
0.2 - 2.5 mm ²	24 - 14 AWG

0.5 mm² 20 AWG

10 mm

IEC60947-7-1 UL-1059 IEC60079-7

1000 V	600 V	630 V
24 A	20 A	21 A



Polyamide 6,6 / 1

8 KV / 3

Type / Cat. No.	Standard Pack
CPDL2.5(I.S)	50
EPCXDL2.5	50
CA701-1M / CA701-1M-S	50 m
CA701-15-1M / CA701-15-1M-S	25 m
CA103 / CA104	50
CA509/K5WHT	100
MC5	10
TM5	50
SCM0.5/3 Blade size: 0.5 x 3 mm	10

Type / Cat. No.	I _{max}	Standard Pack
JX2.5/2	24 A	100
JX2.5/3	24 A	50
JX2.5/4	24 A	50
JX2.5/5	24 A	50
JX2.5/6	24 A	10
JX2.5/7	24 A	10
JX2.5/8	24 A	10
JX2.5/10	24 A	10
JX2.5/20	24 A	10
TX2.5		20

CPDLG2.5

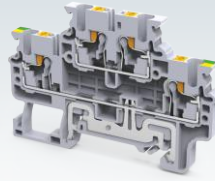

CPDLG2.5(I.S)

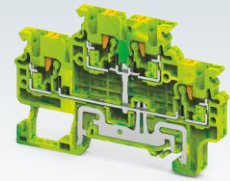

Width (Thickness) x Length	5 x 72.7 mm		5 x 72.7 mm	
Height with DIN 35 x 7.5 / 35 x 15 mm Rail	49.6 mm / 57 mm		49.6 mm / 57 mm	
Connection Possibility as per	IEC	UL - CSA	IEC	UL - CSA
	With 1 Conductor per clamp	Stranded / Flexible Solid with Ferrule / Lug	0.2 - 2.5 mm ² 0.2 - 4.0 mm ² 0.2 - 2.5 mm ²	24 - 12 AWG 24 - 10 AWG 24 - 14 AWG
With 2 same size Conductors per clamp	with TWIN Ferrule / Lug	0.5 mm ²	20 AWG	0.5 mm ² 20 AWG
Wire Stripping Length	10 mm		10 mm	
Ratings As Per	IEC60947-7-1	UL-1059	IEC60079-7	
Voltage	1000 V	600 V	630 V	
Current	Top Level - 24 A Top Level - 20 A Top Level - 21 A			
Approval				
Insulation Material / Material Group	Polyamide 6,6 / 1		Polyamide 6,6 / 1	
Rated Impulse Voltage / Pollution Degree	8 KV / 3		8 KV / 3	

	Type / Cat. No.	Standard Pack	Type / Cat. No.	Standard Pack			
Terminal Block	Grey	CPDLG2.5	50	CPDLG2.5(I.S)	50		
	Blue						
	Red						
	Yellow						
	Black						
	Green						
	Ground / Earth						
End Plate		EPCXDL2.5	50	EPCXDL2.5	50		
Mounting Rail (Refer Pg. 263 for details)		CA701-1M / CA701-1M-S	50 m	CA701-1M / CA701-1M-S	50 m		
		CA701-15-1M / CA701-15-1M-S	25 m	CA701-15-1M / CA701-15-1M-S	25 m		
End Clamp (Refer Pg. 264 for details)		CA103 / CA104	50	CA103 / CA104	50		
Marking Tags (Refer Pg. 268 for details)		CA509/K5WHT	100	CA509/K5WHT	100		
Marker Card (Refer Pg. 269 for details)		MC5	10	MC5	10		
Tree Marker		TM5	50	TM5	50		
Screw Driver		SCM0.5/3	Blade size: 0.5 x 3 mm	10	SCM0.5/3	Blade size: 0.5 x 3 mm	10

	Type / Cat. No.	I _{max}	Standard Pack	Type / Cat. No.	I _{max}	Standard Pack	
Jumpers	2 pole	JX2.5/2	24 A	100	JX2.5/2	24 A	100
	3 pole	JX2.5/3	24 A	50	JX2.5/3	24 A	50
	4 pole	JX2.5/4	24 A	50	JX2.5/4	24 A	50
	5 pole	JX2.5/5	24 A	50	JX2.5/5	24 A	50
	6 pole	JX2.5/6	24 A	10	JX2.5/6	24 A	10
	7 pole	JX2.5/7	24 A	10	JX2.5/7	24 A	10
	8 pole	JX2.5/8	24 A	10	JX2.5/8	24 A	10
	10 pole	JX2.5/10	24 A	10	JX2.5/10	24 A	10
	20 pole	JX2.5/20	24 A	10	JX2.5/20	24 A	10
	Test Plug		TX2.5		20	TX2.5	

DOUBLE LEVEL TERMINAL BLOCKS

CPDL4

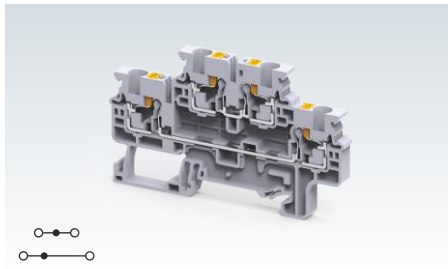

CPDL4(I.S)

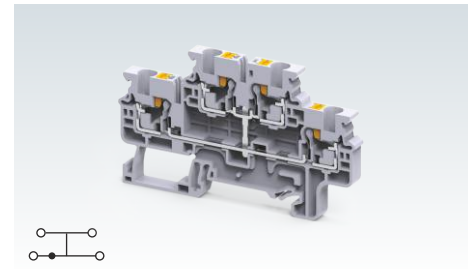

Width (Thickness) x Length	6 x 83.2 mm																		
Height with DIN 35 x 7.5 / 35 x 15 mm Rail	49.6 mm / 57 mm																		
Connection Possibility as per	<table border="1"> <tr> <th>IEC</th> <th>UL - CSA</th> </tr> <tr> <td>With 1 Conductor per clamp</td> <td> <table border="1"> <tr> <td>Stranded / Flexible</td> <td>0.2 - 4.0 mm²</td> <td>24 - 10 AWG</td> </tr> <tr> <td>Solid</td> <td>0.2 - 6.0 mm²</td> <td></td> </tr> <tr> <td>with Ferrule / Lug</td> <td>0.2 - 4.0 mm²</td> <td>24 - 10 AWG</td> </tr> </table> </td> </tr> <tr> <td>With 2 same size Conductors per clamp</td> <td>with TWIN Ferrule / Lug</td> <td>0.5 - 1.0 mm²</td> <td>20 - 18 AWG</td> </tr> </table>		IEC	UL - CSA	With 1 Conductor per clamp	<table border="1"> <tr> <td>Stranded / Flexible</td> <td>0.2 - 4.0 mm²</td> <td>24 - 10 AWG</td> </tr> <tr> <td>Solid</td> <td>0.2 - 6.0 mm²</td> <td></td> </tr> <tr> <td>with Ferrule / Lug</td> <td>0.2 - 4.0 mm²</td> <td>24 - 10 AWG</td> </tr> </table>	Stranded / Flexible	0.2 - 4.0 mm ²	24 - 10 AWG	Solid	0.2 - 6.0 mm ²		with Ferrule / Lug	0.2 - 4.0 mm ²	24 - 10 AWG	With 2 same size Conductors per clamp	with TWIN Ferrule / Lug	0.5 - 1.0 mm ²	20 - 18 AWG
IEC	UL - CSA																		
With 1 Conductor per clamp	<table border="1"> <tr> <td>Stranded / Flexible</td> <td>0.2 - 4.0 mm²</td> <td>24 - 10 AWG</td> </tr> <tr> <td>Solid</td> <td>0.2 - 6.0 mm²</td> <td></td> </tr> <tr> <td>with Ferrule / Lug</td> <td>0.2 - 4.0 mm²</td> <td>24 - 10 AWG</td> </tr> </table>	Stranded / Flexible	0.2 - 4.0 mm ²	24 - 10 AWG	Solid	0.2 - 6.0 mm ²		with Ferrule / Lug	0.2 - 4.0 mm ²	24 - 10 AWG									
Stranded / Flexible	0.2 - 4.0 mm ²	24 - 10 AWG																	
Solid	0.2 - 6.0 mm ²																		
with Ferrule / Lug	0.2 - 4.0 mm ²	24 - 10 AWG																	
With 2 same size Conductors per clamp	with TWIN Ferrule / Lug	0.5 - 1.0 mm ²	20 - 18 AWG																
Wire Stripping Length	11 mm																		
Ratings As Per	IEC60947-7-1 UL-1059																		
Voltage	1000 V	600 V																	
Current	32 A	30 A																	
Approval																			
Insulation Material / Material Group	Polyamide 6,6 / 1																		
Rated Impulse Voltage / Pollution Degree	8 KV / 3																		

Width (Thickness) x Length	6 x 83.2 mm																		
Height with DIN 35 x 7.5 / 35 x 15 mm Rail	49.6 mm / 57 mm																		
Connection Possibility as per	<table border="1"> <tr> <th>IEC</th> <th>UL - CSA</th> </tr> <tr> <td>With 1 Conductor per clamp</td> <td> <table border="1"> <tr> <td>Stranded / Flexible</td> <td>0.2 - 4.0 mm²</td> <td>24 - 10 AWG</td> </tr> <tr> <td>Solid</td> <td>0.2 - 6.0 mm²</td> <td></td> </tr> <tr> <td>with Ferrule / Lug</td> <td>0.2 - 4.0 mm²</td> <td>24 - 10 AWG</td> </tr> </table> </td> </tr> <tr> <td>With 2 same size Conductors per clamp</td> <td>with TWIN Ferrule / Lug</td> <td>0.5 - 1.0 mm²</td> <td>20 - 18 AWG</td> </tr> </table>		IEC	UL - CSA	With 1 Conductor per clamp	<table border="1"> <tr> <td>Stranded / Flexible</td> <td>0.2 - 4.0 mm²</td> <td>24 - 10 AWG</td> </tr> <tr> <td>Solid</td> <td>0.2 - 6.0 mm²</td> <td></td> </tr> <tr> <td>with Ferrule / Lug</td> <td>0.2 - 4.0 mm²</td> <td>24 - 10 AWG</td> </tr> </table>	Stranded / Flexible	0.2 - 4.0 mm ²	24 - 10 AWG	Solid	0.2 - 6.0 mm ²		with Ferrule / Lug	0.2 - 4.0 mm ²	24 - 10 AWG	With 2 same size Conductors per clamp	with TWIN Ferrule / Lug	0.5 - 1.0 mm ²	20 - 18 AWG
IEC	UL - CSA																		
With 1 Conductor per clamp	<table border="1"> <tr> <td>Stranded / Flexible</td> <td>0.2 - 4.0 mm²</td> <td>24 - 10 AWG</td> </tr> <tr> <td>Solid</td> <td>0.2 - 6.0 mm²</td> <td></td> </tr> <tr> <td>with Ferrule / Lug</td> <td>0.2 - 4.0 mm²</td> <td>24 - 10 AWG</td> </tr> </table>	Stranded / Flexible	0.2 - 4.0 mm ²	24 - 10 AWG	Solid	0.2 - 6.0 mm ²		with Ferrule / Lug	0.2 - 4.0 mm ²	24 - 10 AWG									
Stranded / Flexible	0.2 - 4.0 mm ²	24 - 10 AWG																	
Solid	0.2 - 6.0 mm ²																		
with Ferrule / Lug	0.2 - 4.0 mm ²	24 - 10 AWG																	
With 2 same size Conductors per clamp	with TWIN Ferrule / Lug	0.5 - 1.0 mm ²	20 - 18 AWG																
Wire Stripping Length	11 mm																		
Ratings As Per	IEC60947-7-1 UL-1059																		
Voltage	1000 V	600 V																	
Current	32 A	30 A																	
Approval																			
Insulation Material / Material Group	Polyamide 6,6 / 1																		
Rated Impulse Voltage / Pollution Degree	8 KV / 3																		

Width (Thickness) x Length	6 x 83.2 mm																		
Height with DIN 35 x 7.5 / 35 x 15 mm Rail	49.6 mm / 57 mm																		
Connection Possibility as per	<table border="1"> <tr> <th>IEC</th> <th>UL - CSA</th> </tr> <tr> <td>With 1 Conductor per clamp</td> <td> <table border="1"> <tr> <td>Stranded / Flexible</td> <td>0.2 - 4.0 mm²</td> <td>24 - 10 AWG</td> </tr> <tr> <td>Solid</td> <td>0.2 - 6.0 mm²</td> <td></td> </tr> <tr> <td>with Ferrule / Lug</td> <td>0.2 - 4.0 mm²</td> <td>24 - 10 AWG</td> </tr> </table> </td> </tr> <tr> <td>With 2 same size Conductors per clamp</td> <td>with TWIN Ferrule / Lug</td> <td>0.5 - 1.0 mm²</td> <td>20 - 18 AWG</td> </tr> </table>		IEC	UL - CSA	With 1 Conductor per clamp	<table border="1"> <tr> <td>Stranded / Flexible</td> <td>0.2 - 4.0 mm²</td> <td>24 - 10 AWG</td> </tr> <tr> <td>Solid</td> <td>0.2 - 6.0 mm²</td> <td></td> </tr> <tr> <td>with Ferrule / Lug</td> <td>0.2 - 4.0 mm²</td> <td>24 - 10 AWG</td> </tr> </table>	Stranded / Flexible	0.2 - 4.0 mm ²	24 - 10 AWG	Solid	0.2 - 6.0 mm ²		with Ferrule / Lug	0.2 - 4.0 mm ²	24 - 10 AWG	With 2 same size Conductors per clamp	with TWIN Ferrule / Lug	0.5 - 1.0 mm ²	20 - 18 AWG
IEC	UL - CSA																		
With 1 Conductor per clamp	<table border="1"> <tr> <td>Stranded / Flexible</td> <td>0.2 - 4.0 mm²</td> <td>24 - 10 AWG</td> </tr> <tr> <td>Solid</td> <td>0.2 - 6.0 mm²</td> <td></td> </tr> <tr> <td>with Ferrule / Lug</td> <td>0.2 - 4.0 mm²</td> <td>24 - 10 AWG</td> </tr> </table>	Stranded / Flexible	0.2 - 4.0 mm ²	24 - 10 AWG	Solid	0.2 - 6.0 mm ²		with Ferrule / Lug	0.2 - 4.0 mm ²	24 - 10 AWG									
Stranded / Flexible	0.2 - 4.0 mm ²	24 - 10 AWG																	
Solid	0.2 - 6.0 mm ²																		
with Ferrule / Lug	0.2 - 4.0 mm ²	24 - 10 AWG																	
With 2 same size Conductors per clamp	with TWIN Ferrule / Lug	0.5 - 1.0 mm ²	20 - 18 AWG																
Wire Stripping Length	11 mm																		
Ratings As Per	IEC60947-7-1 UL-1059																		
Voltage	1000 V	600 V																	
Current	32 A	30 A																	
Approval																			
Insulation Material / Material Group	Polyamide 6,6 / 1																		
Rated Impulse Voltage / Pollution Degree	8 KV / 3																		

Terminal Block		
End Plate		
Mounting Rail (Refer Pg. 263 for details)		
End Clamp (Refer Pg. 264 for details)		
Marking Tags (Refer Pg. 268 for details)		
Marker Card (Refer Pg. 269 for details)		
Screw Driver		

Type / Cat. No.	Standard Pack
CPDL4	50
EPCPDL4	50
CA701-1M / CA701-1M-S	50 m
CA701-15-1M / CA701-15-1M-S	25 m
CA103 / CA104	50
CA509/K6WHT	100
MC6	10
SCM0.6/33.5 Blade size: 0.6 x 3.5 mm	10

Type / Cat. No.	Standard Pack
CPDL4(I.S)	50
EPCPDL4	50
CA701-1M / CA701-1M-S	50 m
CA701-15-1M / CA701-15-1M-S	25 m
CA103 / CA104	50
CA509/K6WHT	100
MC6	10
SCM0.6/3.5 Blade size: 0.6 x 3.5 mm	10

Jumpers	Type / Cat. No.	I _{max}	Standard Pack	
Pluggable Jumpers	2 pole	JX4/2	32 A	100
	3 pole	JX4/3	32 A	50
	4 pole	JX4/4	32 A	50
	5 pole	JX4/5	32 A	50
	6 pole	JX4/6	32 A	50
	8 pole	JX4/8	32 A	10
	10 pole	JX4/10	32 A	10
16 pole	JX4/16	32 A	10	

Type / Cat. No.	I _{max}	Standard Pack
JX4/2	32 A	100
JX4/3	32 A	50
JX4/4	32 A	50
JX4/5	32 A	50
JX4/6	32 A	50
JX4/8	32 A	10
JX4/10	32 A	10
JX4/16	32 A	10

Type / Cat. No.	I _{max}	Standard Pack
JX4/2	32 A	100
JX4/3	32 A	50
JX4/4	32 A	50
JX4/5	32 A	50
JX4/6	32 A	50
JX4/8	32 A	10
JX4/10	32 A	10
JX4/16	32 A	10

DOUBLE LEVEL TERMINAL BLOCKS

CPDLG4

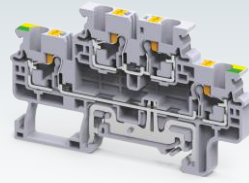

CPDLG4(I.S)

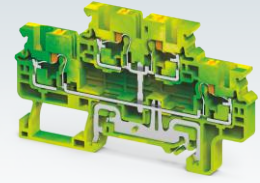

Width (Thickness) x Length	6 x 83.2 mm		6 x 83.2 mm	
Height with DIN 35 x 7.5 / 35 x 15 mm Rail	49.6 mm / 57 mm		49.6 mm / 57 mm	
Connection Possibility as per	IEC		UL - CSA	
	With 1 Conductor per clamp	Stranded / Flexible Solid with Ferrule / Lug	0.2 - 4.0 mm ² 0.2 - 6.0 mm ² 0.2 - 4.0 mm ²	24 - 10 AWG 24 - 10 AWG 24 - 10 AWG
	With 2 same size Conductors per clamp	with TWIN Ferrule / Lug	0.5 - 1.0 mm ²	20 - 18 AWG
Wire Stripping Length	11 mm		11 mm	
Ratings As Per	IEC60947-7-1 UL-1059			
Voltage	1000 V	600 V		
Current	Top Level - 32 A Top Level - 30 A			
Approval				
Insulation Material / Material Group	Polyamide 6,6 / 1		Polyamide 6,6 / 1	
Rated Impulse Voltage / Pollution Degree	8 KV / 3		8 KV / 3	

	Type / Cat. No.	Standard Pack	Type / Cat. No.	Standard Pack			
Terminal Block	CPDLG4	50	CPDLG4(I.S)	50			
End Plate	EPCPDL4	50	EPCPDL4	50			
Mounting Rail (Refer Pg. 263 for details)	CA701-1M / CA701-1M-S CA701-15-1M / CA701-15-1M-S	50 m 25 m	CA701-1M / CA701-1M-S CA701-15-1M / CA701-15-1M-S	50 m 25 m			
End Clamp (Refer Pg. 264 for details)	CA103 / CA104	50	CA103 / CA104	50			
Marking Tags (Refer Pg. 268 for details)	CA509/K6WHT	100	CA509/K6WHT	100			
Marker Card (Refer Pg. 269 for details)	MC6	10	MC6	10			
Screw Driver	SCM0.6/3.5 Blade size: 0.6 x 3.5 mm	10	SCM0.6/3.5 Blade size: 0.6 x 3.5 mm	10			
Jumpers	Type / Cat. No.	I_{max}	Standard Pack	Type / Cat. No.	I_{max}	Standard Pack	
Pluggable Jumpers	2 pole	JX4/2	32 A	100	JX4/2	32 A	100
	3 pole	JX4/3	32 A	50	JX4/3	32 A	50
	4 pole	JX4/4	32 A	50	JX4/4	32 A	50
	5 pole	JX4/5	32 A	50	JX4/5	32 A	50
	6 pole	JX4/6	32 A	50	JX4/6	32 A	50
	8 pole	JX4/8	32 A	10	JX4/8	32 A	10
	10 pole	JX4/10	32 A	10	JX4/10	32 A	10
	16 pole	JX4/16	32 A	10	JX4/16	32 A	10

TRIPLE LEVEL TERMINAL BLOCKS

CPTL2.5 is three level feed through Terminal Block. This is a practical solution for creating high density wiring circuits.

CPTL2.5(I.S) is a three level internally shorted version and is an ideal choice for distribution circuits.

CPTLG2.5 has 2 levels of feed through function with a grounding feet on the third level.

In CPTLG2.5(I.S) all three levels are internally shorted to the ground contact.

CP4LG2.5 is 3 level feed through Terminal Block with a grounding feet on the fourth level. This is suitable for three phase wire connection applications.

CPTL2.5

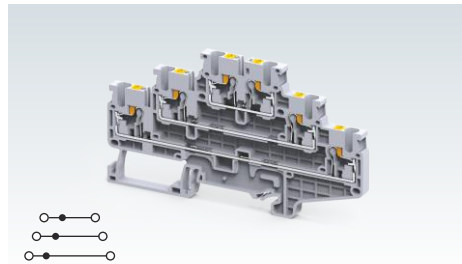

Width (Thickness) x Length	5 x 102 mm		
Height with DIN 35 x 7.5 / 35 x 15 mm Rail	57.3 mm / 64.8 mm		
Connection Possibility as per	IEC	UL - CSA	
With 1 Conductor per clamp	Stranded / Flexible	0.2 - 2.5 mm ²	24 - 12 AWG
	Solid	0.2 - 4.0 mm ²	24 - 10 AWG
	with Ferrule / Lug	0.2 - 2.5 mm ²	24 - 14 AWG
With 2 same size Conductors per clamp	with TWIN Ferrule / Lug	0.5 mm ²	20 AWG
Wire Stripping Length	10 mm		
Ratings As Per	IEC60947-7-1	UL-1059	IEC60079-7
Voltage	500 V	300 V	300 V
Current	24 A	20 A	21 A
Approvals			
Insulation Material / Comparative Tracking Index	Polyamide 6,6 / 1		
Rated Impulse Voltage / Pollution Degree	6 KV / 3		

	Type / Cat. No.	Standard Pack	
Terminal Block	Grey	CPTL2.5	50
	Blue	CPTL2.5BU	50
End Plate	EPCPTL2.5	50	
Mounting Rail (Refer Pg. 263 for details)	CA701-1M / CA701-1M-S	50 m	
	CA701-15-1M / CA701-15-1M-S	25 m	
End Clamp (Refer Pg. 264 for details)	CA202 / CA103 / CA104	50	
Marking Tags (Refer Pg. 268 for details)	MS5WHT	100	
Screw Driver	SCM0.5/3 Blade size: 0.5 x 3 mm	10	

	Type / Cat. No.	Imax	Standard Pack	
Pluggable Jumpers	2 pole	JX2.5/2	24 A	100
	3 pole	JX2.5/3	24 A	50
	4 pole	JX2.5/4	24 A	50
	5 pole	JX2.5/5	24 A	50
	6 pole	JX2.5/6	24 A	10
	7 pole	JX2.5/7	24 A	10
	8 pole	JX2.5/8	24 A	10
	10 pole	JX2.5/10	24 A	10
	20 pole	JX2.5/20	24 A	10
Test Plug	TX2.5		20	

CPTL2.5(I.S)

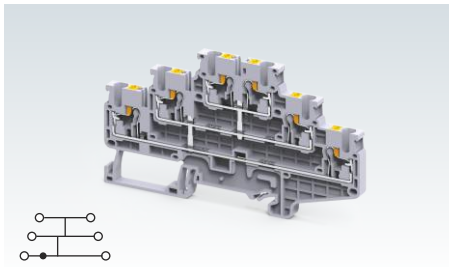

CPTLG2.5

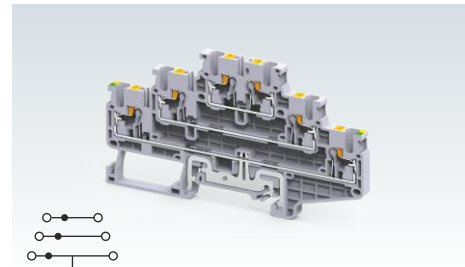

Width (Thickness) x Length	5 x 102 mm	
Height with DIN 35 x 7.5 / 35 x 15 mm Rail	57.3 mm / 64.8 mm	
Connection Possibility as per	IEC	UL - CSA
With 1 Conductor per clamp	Stranded / Flexible	0.2 - 2.5 mm ²
	Solid	0.2 - 4.0 mm ²
	with Ferrule / Lug	0.2 - 2.5 mm ²
With 2 same size Conductors per clamp	with TWIN Ferrule / Lug	0.5 mm ²
Wire Stripping Length	10 mm	
Ratings As Per	IEC60947-7-1	UL-1059 IEC60079-7
Voltage	500 V	300 V
Current	24 A	20 A
Approvals		
Insulation Material / Comparative Tracking Index	Polyamide 6,6 / 1	
Rated Impulse Voltage / Pollution Degree	6 KV / 3	

Width (Thickness) x Length	5 x 102 mm	
Height with DIN 35 x 7.5 / 35 x 15 mm Rail	57.3 mm / 64.8 mm	
Connection Possibility as per	IEC	UL - CSA
With 1 Conductor per clamp	Stranded / Flexible	0.2 - 2.5 mm ²
	Solid	0.2 - 4.0 mm ²
	with Ferrule / Lug	0.2 - 2.5 mm ²
With 2 same size Conductors per clamp	with TWIN Ferrule / Lug	0.5 mm ²
Wire Stripping Length	10 mm	
Ratings As Per	IEC60947-7-1	UL-1059 IEC60079-7
Voltage	500 V	300 V
Current	24 A	21 A
Approvals		
Insulation Material / Comparative Tracking Index	Polyamide 6,6 / 1	
Rated Impulse Voltage / Pollution Degree	6 KV / 3	

Width (Thickness) x Length	5 x 102 mm	
Height with DIN 35 x 7.5 / 35 x 15 mm Rail	57.3 mm / 64.8 mm	
Connection Possibility as per	IEC	UL - CSA
With 1 Conductor per clamp	Stranded / Flexible	0.2 - 2.5 mm ²
	Solid	0.2 - 4.0 mm ²
	with Ferrule / Lug	0.2 - 2.5 mm ²
With 2 same size Conductors per clamp	with TWIN Ferrule / Lug	0.5 mm ²
Wire Stripping Length	10 mm	
Ratings As Per	IEC60947-7-1	UL-1059 IEC60079-7
Voltage	500 V	300 V
Current	24 A	21 A
Approvals		
Insulation Material / Comparative Tracking Index	Polyamide 6,6 / 1	
Rated Impulse Voltage / Pollution Degree	6 KV / 3	

Terminal Block	CPTL2.5(I.S)	50
End Plate	EPCPTL2.5	50
Mounting Rail (Refer Pg. 263 for details)	CA701-1M / CA701-1M-S	50 m
	CA701-15-1M / CA701-15-1M-S	25 m
End Clamp (Refer Pg. 264 for details)	CA202 / CA103 / CA104	50
Marking Tags (Refer Pg. 268 for details)	MS5WHT	100
Screw Driver	SCM0.5/3 Blade size: 0.5 x 3 mm	10

Terminal Block	CPTL2.5(I.S)	50
End Plate	EPCPTL2.5	50
Mounting Rail (Refer Pg. 263 for details)	CA701-1M / CA701-1M-S	50 m
	CA701-15-1M / CA701-15-1M-S	25 m
End Clamp (Refer Pg. 264 for details)	CA202 / CA103 / CA104	50
Marking Tags (Refer Pg. 268 for details)	MS5WHT	100
Screw Driver	SCM0.5/3 Blade size: 0.5 x 3 mm	10

Terminal Block	CPTL2.5(I.S)	50
End Plate	EPCPTL2.5	50
Mounting Rail (Refer Pg. 263 for details)	CA701-1M / CA701-1M-S	50 m
	CA701-15-1M / CA701-15-1M-S	25 m
End Clamp (Refer Pg. 264 for details)	CA202 / CA103 / CA104	50
Marking Tags (Refer Pg. 268 for details)	MS5WHT	100
Screw Driver	SCM0.5/3 Blade size: 0.5 x 3 mm	10

Jumpers		Type / Cat. No.	Imax	Standard Pack
Pluggable Jumpers		2 pole	JX2.5/2	24 A
		3 pole	JX2.5/3	24 A
		4 pole	JX2.5/4	24 A
		5 pole	JX2.5/5	24 A
		6 pole	JX2.5/6	24 A
		7 pole	JX2.5/7	24 A
		8 pole	JX2.5/8	24 A
		10 pole	JX2.5/10	24 A
20 pole	JX2.5/20	24 A		
Test Plug		TX2.5		20

Jumpers		Type / Cat. No.	Imax	Standard Pack
Pluggable Jumpers		2 pole	JX2.5/2	24 A
		3 pole	JX2.5/3	24 A
		4 pole	JX2.5/4	24 A
		5 pole	JX2.5/5	24 A
		6 pole	JX2.5/6	24 A
		7 pole	JX2.5/7	24 A
		8 pole	JX2.5/8	24 A
		10 pole	JX2.5/10	24 A
20 pole	JX2.5/20	24 A		
Test Plug		TX2.5		20

Jumpers		Type / Cat. No.	Imax	Standard Pack
Pluggable Jumpers		2 pole	JX2.5/2	24 A
		3 pole	JX2.5/3	24 A
		4 pole	JX2.5/4	24 A
		5 pole	JX2.5/5	24 A
		6 pole	JX2.5/6	24 A
		7 pole	JX2.5/7	24 A
		8 pole	JX2.5/8	24 A
		10 pole	JX2.5/10	24 A
20 pole	JX2.5/20	24 A		
Test Plug		TX2.5		20

CPTLG2.5(I.S)

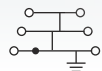
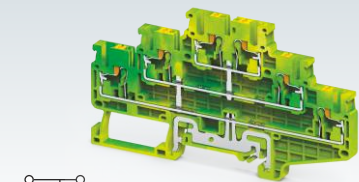

5 x 102 mm

57.3 mm / 64.8 mm

IEC	UL - CSA
0.2 - 2.5 mm ²	24 - 12 AWG
0.2 - 4.0 mm ²	24 - 10 AWG
0.2 - 2.5 mm ²	24 - 14 AWG

0.5 mm² 20 AWG

10 mm



Polyamide 6,6 / 1

6 KV / 3

Type / Cat. No.	Standard Pack
CPTLG2.5(I.S)	50
EPCPTL2.5	50
CA701-1M / CA701-1M-S	50 m
CA701-15-1M / CA701-15-1M-S	25 m
CA202 / CA103 / CA104	50
MS5WHT	100
SCM0.5/3 Blade size: 0.5 x 3 mm	10

Type / Cat. No.	I _{max}	Standard Pack
JX2.5/2	24 A	100
JX2.5/3	24 A	50
JX2.5/4	24 A	50
JX2.5/5	24 A	50
JX2.5/6	24 A	10
JX2.5/7	24 A	10
JX2.5/8	24 A	10
JX2.5/10	24 A	10
JX2.5/20	24 A	10
TX2.5		20

CP4LG2.5

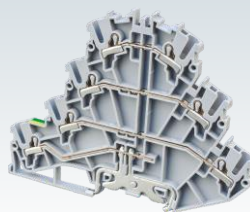

5 x 118.6 mm

93 mm / 100.5 mm

IEC	UL - CSA
0.34 - 2.5 mm ²	22 - 12 AWG
0.34 - 4.0 mm ²	22 - 10 AWG
0.34 - 2.5 mm ²	22 - 12 AWG

0.5 mm² 20 AWG

10 mm

IEC60947-7-1 UL-1059

500 V 300 V

24 A 20 A



Polyamide 6,6 / 1

6 KV / 3

Type / Cat. No.	Standard Pack
CP4LG2.5	50
EPCP4LG2.5	30
CA701-1M / CA701-1M-S	50 m
CA701-15-1M / CA701-15-1M-S	25 m
CA202 / CA103	50
CA509/K2GWHT	100
SCM0.5/3 Blade size: 0.5 x 3 mm	10

Type / Cat. No.	I _{max}	Standard Pack
CA801/A2	24 A	100
CA801/A3	24 A	100
CA801/A4	24 A	100
CA801/A10	24 A	10

SENSOR & ACTUATOR TERMINAL BLOCKS

Sensors and actuator Terminal Blocks are ideal for wiring modern machine control systems. These Terminal Blocks are extremely compact with a terminal thickness of 3.5 mm.

CPST1.5/3 is a 3 wire sensor Terminal Block. These terminals can be bridged together with a power feed through terminal CPPT2.5/3 by using standard pluggable jumpers.

CPST1.5/4 is a 4 wire sensor Terminal Block which can be used in conjunction with CPPTG2.5/4 power feed through terminal.

In CPSTG1.5/4 an additional grounding point is available and is colour coded green yellow for clear identification.

CPPT2.5/3 is used to bring in the power connection for 3 wire sensor terminals CPST1.5/3.

CPPTG2.5/4 is used for 4 wire sensor terminals CPST1.5/4 & CPSTG1.5/4.

Blue & Red colour jumpers are available for clear circuit identification.

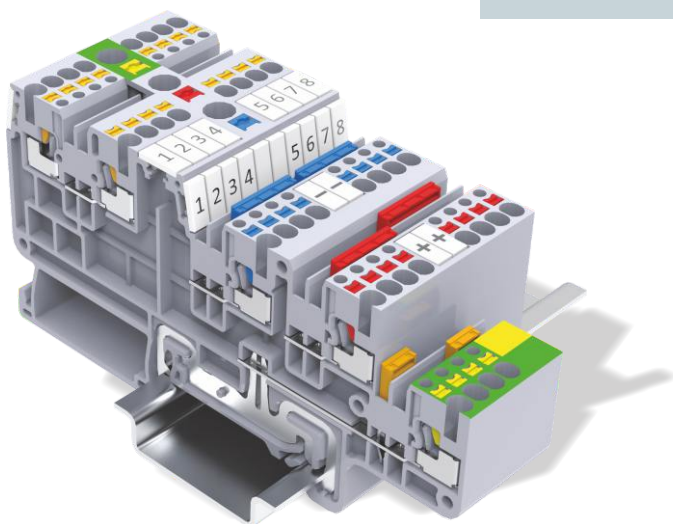

CPST1.5/3

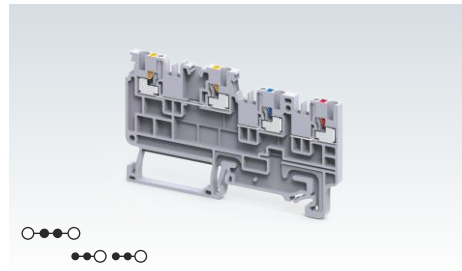

Width (Thickness) x Length	3.5 x 79.8 mm																			
Height with DIN 35 x 7.5 / 35 x 15	48.1 mm / 55.6 mm																			
Connection Possibility as per	<table border="1"> <tr> <th>IEC</th> <th colspan="3">UL - CSA</th> </tr> <tr> <td>0.2 - 1.5 mm²</td> <td colspan="3">24 - 14 AWG</td> </tr> <tr> <td>0.2 - 2.5 mm²</td> <td colspan="3">24 - 12 AWG</td> </tr> <tr> <td>0.2 - 1.0 mm²</td> <td colspan="3">24 - 18 AWG</td> </tr> </table>				IEC	UL - CSA			0.2 - 1.5 mm ²	24 - 14 AWG			0.2 - 2.5 mm ²	24 - 12 AWG			0.2 - 1.0 mm ²	24 - 18 AWG		
IEC	UL - CSA																			
0.2 - 1.5 mm ²	24 - 14 AWG																			
0.2 - 2.5 mm ²	24 - 12 AWG																			
0.2 - 1.0 mm ²	24 - 18 AWG																			
With 1 Conductor per clamp	Stranded / Flexible			with TWIN Ferrule / Lug																
	Solid																			
With 2 same size Conductors per clamp																				
Wire Stripping Length	8 mm																			
Ratings As Per	IEC60947-7-1 UL-1059 CSA22.2-158 IEC60079-7																			
Voltage	250 V	150 V	150 V	150 V																
Current	13.5 A	15 A	15 A	12 A																
Approvals																				
Insulation Material / Material Group	Polyamide 6,6 / 1																			
Rated Impulse Voltage / Pollution Degree	4 KV / 3																			

		Type / Cat. No.	Standard Pack																									
Terminal Block	_____	CPST1.5/3	50																									
	_____ With LED Indication	CPST1.5/3L*	50																									
	_____ With Grounding Point																											
_____ With Grounding Point & LED Indication																												
End Plate	_____ For 3 wire Sensor Terminal Block	EPCPPT2.5/3	50																									
	_____ For 4 wire Sensor Terminal Block																											
Mounting Rail	(Refer Pg. 263 for details)	CA701-1M / CA701-1M-S CA701-15-1M / CA701-15-1M-S	50 m 25 m																									
End Clamp	(Refer Pg. 264 for details)	CA103 / CA104	50																									
Marking Tags	(Refer Pg. 268 for details)	MS3.5WHT	100																									
Marker Card	(Refer Pg. 269 for details)	MC3.5	10																									
Screw Driver		SCM0.4/2 Blade size: 0.4 x 2 mm	10																									
Jumpers		<table border="1"> <thead> <tr> <th>Orange Jumper</th> <th>Blue Jumper</th> <th>Red Jumper</th> <th>I_{max}</th> <th>Std. Pack</th> </tr> </thead> <tbody> <tr> <td>JX1.5/2</td> <td>JX1.5/2BU</td> <td>JX1.5/2R</td> <td>16 A</td> <td>100</td> </tr> <tr> <td>JX1.5/3</td> <td>JX1.5/3BU</td> <td>JX1.5/3R</td> <td>16 A</td> <td>100</td> </tr> <tr> <td>JX1.5/4</td> <td>JX1.5/4BU</td> <td>JX1.5/4R</td> <td>16 A</td> <td>100</td> </tr> <tr> <td>JX1.5/10</td> <td>JX1.5/10BU</td> <td>JX1.5/10R</td> <td>16 A</td> <td>10</td> </tr> </tbody> </table>	Orange Jumper	Blue Jumper	Red Jumper	I _{max}	Std. Pack	JX1.5/2	JX1.5/2BU	JX1.5/2R	16 A	100	JX1.5/3	JX1.5/3BU	JX1.5/3R	16 A	100	JX1.5/4	JX1.5/4BU	JX1.5/4R	16 A	100	JX1.5/10	JX1.5/10BU	JX1.5/10R	16 A	10	
Orange Jumper	Blue Jumper	Red Jumper	I _{max}	Std. Pack																								
JX1.5/2	JX1.5/2BU	JX1.5/2R	16 A	100																								
JX1.5/3	JX1.5/3BU	JX1.5/3R	16 A	100																								
JX1.5/4	JX1.5/4BU	JX1.5/4R	16 A	100																								
JX1.5/10	JX1.5/10BU	JX1.5/10R	16 A	10																								
Pluggable Jumpers		2 pole																										
		3 pole																										
		4 pole																										
		10 pole																										

* Standard voltage range for LED indication of 6-60 V & 110-240 V available.

CPST1.5/4

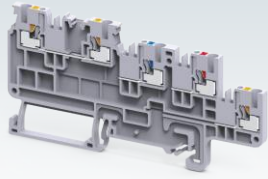

3.5 x 96.5 mm

48.1 mm / 55.6 mm

IEC	UL - CSA
0.2 - 1.5 mm ²	24 - 14 AWG
0.2 - 2.5 mm ²	24 - 12 AWG
0.2 - 1.0 mm ²	24 - 18 AWG

8 mm

IEC60947-7-1 UL-1059 CSA22.2-158 IEC60079-7

250 V	150 V	150 V	150 V
13.5 A	15 A	15 A	12 A



Polyamide 6,6 / 1

4 KV / 3

Type / Cat. No.	Standard Pack			
CPST1.5/4	50			
CPST1.5/4L*	50			
EPCPPT2.5/4	50			
CA701-1M / CA701-1M-S	50 m			
CA701-15-1M / CA701-15-1M-S	25 m			
CA103 / CA104	50			
MS3.5WHT	100			
MC3.5	10			
SCM0.4/2 Blade size: 0.4 x 2 mm	10			
Orange Jumper	Blue Jumper	Red Jumper	I _{max}	Std. Pack
JX1.5/2	JX1.5/2BU	JX1.5/2R	16 A	100
JX1.5/3	JX1.5/3BU	JX1.5/3R	16 A	100
JX1.5/4	JX1.5/4BU	JX1.5/4R	16 A	100
JX1.5/10	JX1.5/10BU	JX1.5/10R	16 A	10

CPSTG1.5/4

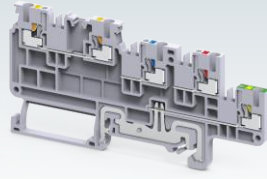

3.5 x 96.5 mm

48.1 mm / 55.6 mm

IEC	UL - CSA
0.2 - 1.5 mm ²	24 - 14 AWG
0.2 - 2.5 mm ²	24 - 12 AWG
0.2 - 1.0 mm ²	24 - 18 AWG

8 mm

IEC60947-7-1 UL-1059 CSA22.2-158 IEC60079-7

250 V	150 V	150 V	150 V
13.5 A	15 A	15 A	12 A



Polyamide 6,6 / 1

4 KV / 3

Type / Cat. No.	Standard Pack			
CPSTG1.5/4	50			
CPSTG1.5/4L*	50			
EPCPPT2.5/4	50			
CA701-1M / CA701-1M-S	50 m			
CA701-15-1M / CA701-15-1M-S	25 m			
CA103 / CA104	50			
MS3.5WHT	100			
MC3.5	10			
SCM0.4/2 Blade size: 0.4 x 2 mm	10			
Orange Jumper	Blue Jumper	Red Jumper	I _{max}	Std. Pack
JX1.5/2	JX1.5/2BU	JX1.5/2R	16 A	100
JX1.5/3	JX1.5/3BU	JX1.5/3R	16 A	100
JX1.5/4	JX1.5/4BU	JX1.5/4R	16 A	100
JX1.5/10	JX1.5/10BU	JX1.5/10R	16 A	10

CPPT2.5/3

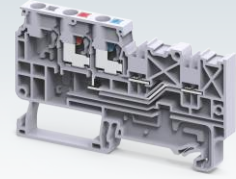

7 x 79.8 mm

48.1 mm / 55.6 mm

IEC	UL - CSA
0.2 - 2.5 mm ²	24 - 14 AWG
0.2 - 4.0 mm ²	24 - 12 AWG
0.2 - 2.5 mm ²	24 - 14 AWG

0.5 mm²

20 AWG

10 mm

IEC60947-7-1 UL-1059 CSA22.2-158 IEC60079-7

250 V	300 V	150 V	150 V
20 A	16 A	15 A	18 A



Polyamide 6,6 / 1

4 KV / 3

Type / Cat. No.	Standard Pack			
CPPT2.5/3	50			
EPCPPT2.5/3	50			
CA701-1M / CA701-1M-S	50 m			
CA701-15-1M / CA701-15-1M-S	25 m			
CA103 / CA104	50			
MS3.5WHT	100			
MC3.5	10			
SCM0.5/3 Blade size: 0.5 x 3 mm	10			
Orange Jumper	Blue Jumper	Red Jumper	I _{max}	Std. Pack
JX1.5/2	JX1.5/2BU	JX1.5/2R	16 A	100
JX1.5/3	JX1.5/3BU	JX1.5/3R	16 A	100
JX1.5/4	JX1.5/4BU	JX1.5/4R	16 A	100
JX1.5/10	JX1.5/10BU	JX1.5/10R	16 A	10

SENSOR & ACTUATOR TERMINAL BLOCKS

CPPT2.5/4

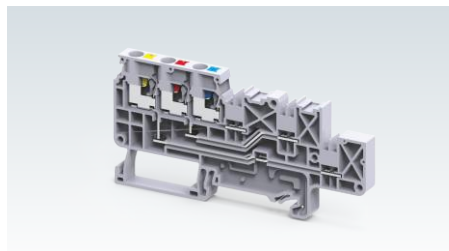

CPPTG2.5/4

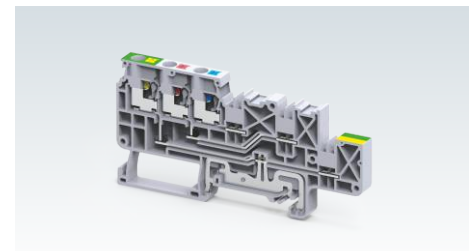

Width (Thickness) x Length	7 x 96.5 mm	
Height with DIN 35 x 7.5 / 35 x 15	48.1 mm / 55.6 mm	
Connection Possibility as per	IEC	
With 1 Conductor per clamp	Stranded / Flexible	0.2 - 2.5 mm ²
	Solid	0.2 - 4.0 mm ²
	with Ferrule / Lug	0.2 - 2.5 mm ²
With 2 same size Conductors per clamp	with TWIN Ferrule / Lug	0.5 mm ²
Wire Stripping Length	10 mm	
Ratings As Per	IEC60947-7-1 UL-1059 CSA22.2-158 IEC60079-7	
Voltage	250 V	300 V
Current	20 A	16 A
Approvals		
Insulation Material / Material Group	Polyamide 6,6 / 1	
Rated Impulse Voltage / Pollution Degree	4 KV / 3	

Width (Thickness) x Length	7 x 96.5 mm	
Height with DIN 35 x 7.5 / 35 x 15	48.1 mm / 55.6 mm	
Connection Possibility as per	IEC	
With 1 Conductor per clamp	Stranded / Flexible	0.2 - 2.5 mm ²
	Solid	0.2 - 4.0 mm ²
	with Ferrule / Lug	0.2 - 2.5 mm ²
With 2 same size Conductors per clamp	with TWIN Ferrule / Lug	0.5 mm ²
Wire Stripping Length	10 mm	
Ratings As Per	IEC60947-7-1 UL-1059 CSA22.2-158 IEC60079-7	
Voltage	250 V	300 V
Current	20 A	16 A
Approvals		
Insulation Material / Material Group	Polyamide 6,6 / 1	
Rated Impulse Voltage / Pollution Degree	4 KV / 3	

Width (Thickness) x Length	7 x 96.5 mm	
Height with DIN 35 x 7.5 / 35 x 15	48.1 mm / 55.6 mm	
Connection Possibility as per	IEC	
With 1 Conductor per clamp	Stranded / Flexible	0.2 - 2.5 mm ²
	Solid	0.2 - 4.0 mm ²
	with Ferrule / Lug	0.2 - 2.5 mm ²
With 2 same size Conductors per clamp	with TWIN Ferrule / Lug	0.5 mm ²
Wire Stripping Length	10 mm	
Ratings As Per	IEC60947-7-1 UL-1059 CSA22.2-158 IEC60079-7	
Voltage	250 V	300 V
Current	20 A	16 A
Approvals		
Insulation Material / Material Group	Polyamide 6,6 / 1	
Rated Impulse Voltage / Pollution Degree	4 KV / 3	

	Type / Cat. No.	Standard Pack				
Terminal Block	CPPT2.5/4	50				
End Plate For 4 wire Sensor Terminal Block	EPCPPT2.5/4	50				
Mounting Rail (Refer Pg. 263 for details)	CA701-1M / CA701-1M-S	50 m				
	CA701-15-1M / CA701-15-1M-S	25 m				
End Clamp (Refer Pg. 264 for details)	CA103 / CA104	50				
Marking Tags (Refer Pg. 268 for details)	MS3.5WHT	100				
Marker Card (Refer Pg. 269 for details)	MC3.5	10				
Screw Driver	SCM0.5/3 Blade size: 0.5 x 3 mm	10				
Jumpers						
Pluggable Jumpers	2 pole	JX1.5/2	JX1.5/2BU	JX1.5/2R	16 A	100
	3 pole	JX1.5/3	JX1.5/3BU	JX1.5/3R	16 A	100
	4 pole	JX1.5/4	JX1.5/4BU	JX1.5/4R	16 A	100
	10 pole	JX1.5/10	JX1.5/10BU	JX1.5/10R	16 A	10

	Type / Cat. No.	Standard Pack				
Terminal Block	CPPTG2.5/4	50				
End Plate For 4 wire Sensor Terminal Block	EPCPPT2.5/4	50				
Mounting Rail (Refer Pg. 263 for details)	CA701-1M / CA701-1M-S	50 m				
	CA701-15-1M / CA701-15-1M-S	25 m				
End Clamp (Refer Pg. 264 for details)	CA103 / CA104	50				
Marking Tags (Refer Pg. 268 for details)	MS3.5WHT	100				
Marker Card (Refer Pg. 269 for details)	MC3.5	10				
Screw Driver	SCM0.5/3 Blade size: 0.5 x 3 mm	10				
Jumpers						
Pluggable Jumpers	2 pole	JX1.5/2	JX1.5/2BU	JX1.5/2R	16 A	100
	3 pole	JX1.5/3	JX1.5/3BU	JX1.5/3R	16 A	100
	4 pole	JX1.5/4	JX1.5/4BU	JX1.5/4R	16 A	100
	10 pole	JX1.5/10	JX1.5/10BU	JX1.5/10R	16 A	10

	Type / Cat. No.	Standard Pack				
Terminal Block	CPPTG2.5/4	50				
End Plate For 4 wire Sensor Terminal Block	EPCPPT2.5/4	50				
Mounting Rail (Refer Pg. 263 for details)	CA701-1M / CA701-1M-S	50 m				
	CA701-15-1M / CA701-15-1M-S	25 m				
End Clamp (Refer Pg. 264 for details)	CA103 / CA104	50				
Marking Tags (Refer Pg. 268 for details)	MS3.5WHT	100				
Marker Card (Refer Pg. 269 for details)	MC3.5	10				
Screw Driver	SCM0.5/3 Blade size: 0.5 x 3 mm	10				
Jumpers						
Pluggable Jumpers	2 pole	JX1.5/2	JX1.5/2BU	JX1.5/2R	16 A	100
	3 pole	JX1.5/3	JX1.5/3BU	JX1.5/3R	16 A	100
	4 pole	JX1.5/4	JX1.5/4BU	JX1.5/4R	16 A	100
	10 pole	JX1.5/10	JX1.5/10BU	JX1.5/10R	16 A	10

COMPONENT CARRIER TERMINAL BLOCKS

CPCC6 Push-In Connection Terminal Block is a component carrier base. Various pluggable component carriers can be installed easily. These component carriers have built in protection against incorrect polarity.

CPCC6

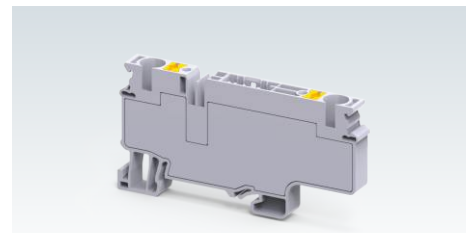

Width (Thickness) x Length	8 x 82.9 mm		
Height with DIN 35 x 7.5 / 35 x 15 mm Rail	43 mm / 50.5 mm		
Connection Possibility as per	IEC	UL - CSA	
With 1 Conductor per clamp	Stranded / Flexible	0.5 - 10.0 mm ²	20 - 8 AWG
	Solid with Ferrule / Lug	0.5 - 10.0 mm ²	20 - 8 AWG
With 2 same size Conductors per clamp	with TWIN Ferrule / Lug	0.5 - 2.5 mm ²	20 - 14 AWG
Wire Stripping Length	12 mm		
Ratings As Per	IEC60947-7-1	UL-1059	
Voltage	1000 V	300 V	
Current	20 A	20 A	
Approval	CE		
Insulation Material / Material Group	Polyamide 6,6 / 1		
Rated Impulse Voltage / Pollution Degree	6 KV / 3		

	Type / Cat. No.	Standard Pack
Terminal Block	CPCC6	50
Mounting Rail (Refer Pg. 263 for details)	CA701-1M / CA701-1M-S	50 m
	CA701-15-1M / CA701-15-1M-S	25 m
End Clamp (Refer Pg. 264 for details)	CA103 / CA104	50
Marking Tags (Refer Pg. 268 for details)	CA509/K8WHT	100
Marker Card (Refer Pg. 269 for details)	MC8	10
Screw Driver	SCM0.8/4 Blade size: 0.8 x 4 mm	10

	Type / Cat. No.	I _{max}	Standard Pack
Shorting Link	JX6/2	41 A	100
	JX6/3	41 A	50
	JX6/4	41 A	50
	JX6/5	41 A	50
	JX6/10	41 A	10
Step Down Jumpers	JXS6/2.5	41 A	50
	JXS6/4	41 A	50

* Current Rating based on component carriers

CC6F is a fuse component plug suitable for Ø 6.3 x 32 mm fuses. CC6FL comes with offline indication in case of blown off fuse.

CC6R is component plug suitable for resistors.

CC6D is component plug suitable 1N4007 and 1N5408 diodes.

CC6F

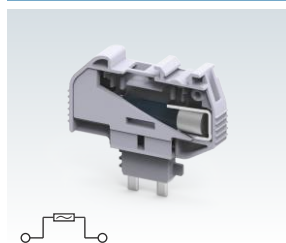

	Type / Cat. No.	Std. Pack
Component Carrier	For Ø 5 x 20 mm Fuse	CC6F 50
	Fuse with 6-60V AC/DC LED Circuit	CC6FL6-60V 50
	Fuse with 110-240V AC/DC LED Circuit	CC6FL110-240V 50
	With Diode	
	With Resistor	
Width (Thickness) x Length x Height	6 x 28 x 35 mm	
* Current Rating	6.3 A	
Marking Tags (Refer Pg. 268 for details)	CA509/K2B4WHT	100
Marker Card	MC2B4WHT	100

CC6R

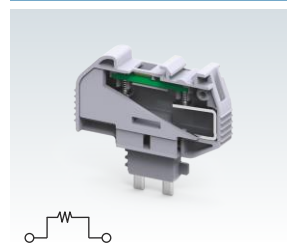

	Type / Cat. No.	Std. Pack
	CC6R	50
Width (Thickness) x Length x Height	6 x 28 x 35 mm	
* Current Rating	1 A	
Marking Tags	CA509/K2B4WHT	100
Marker Card	MC2B4WHT	100

CC6D

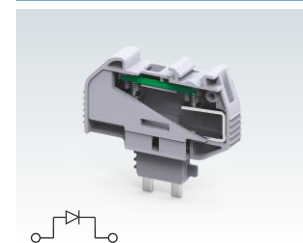

	Type / Cat. No.	Std. Pack
	CC6D	50
Width (Thickness) x Length x Height	6 x 28 x 35 mm	
* Current Rating	1 A	
Marking Tags	CA509/K2B4WHT	100
Marker Card	MC2B4WHT	100

MARSHALLING TERMINAL BLOCKS

CP8L32 is an 8 level marshalling Terminal Block. It offers 32 connection points in a space saving configuration for potential and signal distribution. It has Push-In technology for easy wiring connection. Standard test probes can be inserted to carry out various test protocols.

CP8L32(I.S) is internally shorted Terminal Block offering multiple connection points for distribution applications.

Colour coding provides easy identification of the termination point to ensure error free operation.

In CP8L32(I.S)H the top four levels are interconnected and the bottom four levels are shorted. They are independent of each other and are used for signal distribution applications.

CP8L32

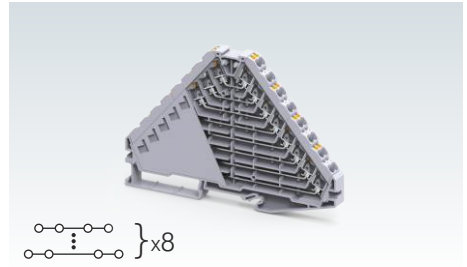

Width (Thickness) x Length	9 x 120 mm			
Height with DIN 35 x 7.5 / 35 x 15 mm Rail	84 mm / 91.6 mm			
Connection Possibility as per	IEC		UL - CSA	
With 1 Conductor per clamp	Stranded / Flexible		24 - 14 AWG	
	Solid		24 - 12 AWG	
	with Ferrule / Lug		24 - 18 AWG	
With 2 same size Conductors per clamp	with TWIN Ferrule / Lug			
Wire Stripping Length	8 mm			
Ratings As Per	IEC60947-7-1	UL-1059	CSA22.2-158	IEC60079-7
Voltage	320 V	300 V	300 V	300 V
Current	8 A	10 A	10 A	10 A
Approval				
Insulation Material / Material Group	Polyamide 6,6 / 1			
Rated Impulse Voltage / Pollution Degree	4 KV / 3			

		Type / Cat. No.	Standard Pack
Terminal Block	Grey	CP8L32	10
	Blue	CP8L32BU	10
	Black	CP8L32BK	10
	Red	CP8L32R	10
Mounting Rail (Refer Pg. 263 for details)		CA701-1M / CA701-1M-S	50 m
		CA701-15-1M / CA701-15-1M-S	25 m
End Clamp (Refer Pg. 264 for details)		CA103 / CA104	50
Separator Plate		SPCP8L32	10
Marker for SP		CA509/K3.5V	80
Marking Tags (Refer Pg. 268 for details)		CA509/K9WHT	100
Screw Driver		SCM0.4/2 Blade size: 0.4 x 2 mm	10

CP8L32(I.S)

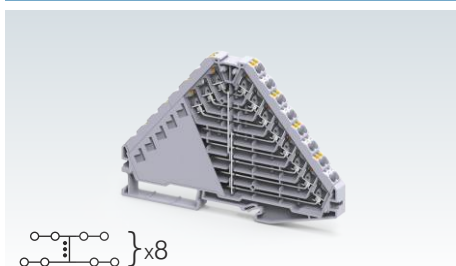

9 x 120 mm
84 mm / 91.6 mm

IEC	UL - CSA
0.2 - 1.5 mm ²	24 - 14 AWG
0.2 - 2.5 mm ²	24 - 12 AWG
0.2 - 1.0 mm ²	24 - 18 AWG

8 mm			
IEC60947-7-1	UL-1059	CSA22.2-158	IEC60079-7
320 V	300 V	300 V	300 V
8 A	10 A	10 A	10 A



Polyamide 6,6 / 1
4 KV / 3

Type / Cat. No.	Standard Pack
CP8L32(I.S)	10
CP8L32(I.S)BU	10
CP8L32(I.S)BK	10
CP8L32(I.S)R	10
CA701-1M / CA701-1M-S	50 m
CA701-15-1M / CA701-15-1M-S	25 m
CA103 / CA104	50
SPCP8L32	10
CA509/K3.5V	80
CA509/K9WHT	100
SCM0.4/2 Blade size: 0.4 x 2 mm	10

CP8L32(I.S)H

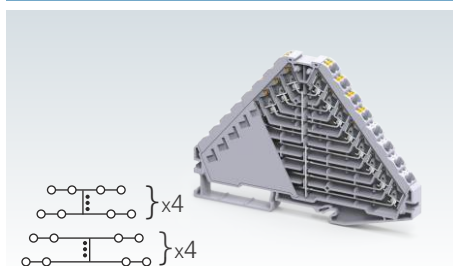

9 x 120 mm
84 mm / 91.6 mm

IEC	UL - CSA
0.2 - 1.5 mm ²	24 - 14 AWG
0.2 - 2.5 mm ²	24 - 12 AWG
0.2 - 1.0 mm ²	24 - 18 AWG

8 mm			
IEC60947-7-1	UL-1059	CSA22.2-158	IEC60079-7
320 V	300 V	300 V	300 V
8 A	10 A	10 A	10 A



Polyamide 6,6 / 1
4 KV / 3

Type / Cat. No.	Standard Pack
CP8L32(I.S)H	10
CA701-1M / CA701-1M-S	50 m
CA701-15-1M / CA701-15-1M-S	25 m
CA103 / CA104	50
SPCP8L32	10
CA509/K3.5V	80
CA509/K9WHT	100
SCM0.4/2 Blade size: 0.4 x 2 mm	10

FUSE TERMINAL BLOCKS

These Terminal Blocks are used in electrical and control systems which require fuse protection.

CPF4 accepts industry standard Ø 5 x 20 mm cartridge fuses.

CPF6 accepts industry standard Ø 6.3 x 32 mm cartridge fuses.

CPAF6 are automotive Fuse Terminal Blocks used to protect the wiring and electrical equipment for vehicles.

CPDLF2.5 are Double Level Fuse Terminal Block with fuse carrier on the top level and a separate feed through connection at the lower level. This eliminates the use of additional feed through Terminal Block.

CPDLFK2.5 are Double Level Fuse Terminal Block with fuse carrier on the top level and disconnect function at the lower level.

Fuse Terminal Blocks with suffix (L) are used for off-line indication in case of fuse blow out.

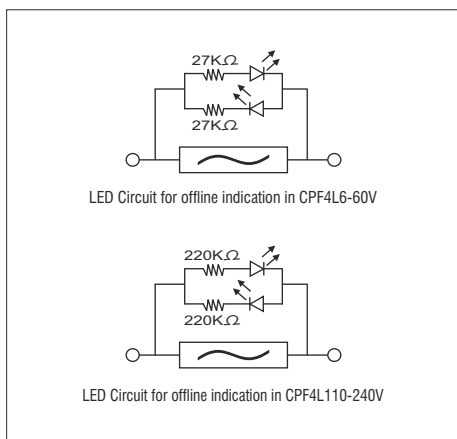

Width (Thickness) x Length	6 x 54.8 mm																							
Height with DIN 35 x 7.5 / 35 x 15 mm Rail	68.8 mm / 76.3 mm																							
Connection Possibility as per	<table border="1"> <tr> <th>IEC</th> <th colspan="3">UL - CSA</th> </tr> <tr> <td>0.2 - 4.0 mm²</td> <td colspan="3">24 - 10 AWG</td> </tr> <tr> <td>0.2 - 6.0 mm²</td> <td colspan="3">24 - 10 AWG</td> </tr> <tr> <td>0.2 - 4.0 mm²</td> <td colspan="3">24 - 10 AWG</td> </tr> <tr> <td>0.5 - 1.0 mm²</td> <td colspan="3">24 - 18 AWG</td> </tr> </table>				IEC	UL - CSA			0.2 - 4.0 mm ²	24 - 10 AWG			0.2 - 6.0 mm ²	24 - 10 AWG			0.2 - 4.0 mm ²	24 - 10 AWG			0.5 - 1.0 mm ²	24 - 18 AWG		
IEC	UL - CSA																							
0.2 - 4.0 mm ²	24 - 10 AWG																							
0.2 - 6.0 mm ²	24 - 10 AWG																							
0.2 - 4.0 mm ²	24 - 10 AWG																							
0.5 - 1.0 mm ²	24 - 18 AWG																							
With 1 Conductor per clamp	Stranded / Flexible																							
	Solid																							
	with Ferrule / Lug																							
With 2 same size Conductors per clamp	with TWIN Ferrule / Lug																							
Wire Stripping Length	10 mm																							
Ratings As Per	IEC60947-3	UL-1059	CSA22.2-158	IEC60079-7																				
Voltage	1000 V	600 V	600 V	630 V																				
Current	10A	10A	10 A	6.3 A																				
Approval																								
Insulation Material / Material Group	Polyamide 6,6 / 1																							
Rated Impulse Voltage / Pollution Degree	4 KV / 3																							

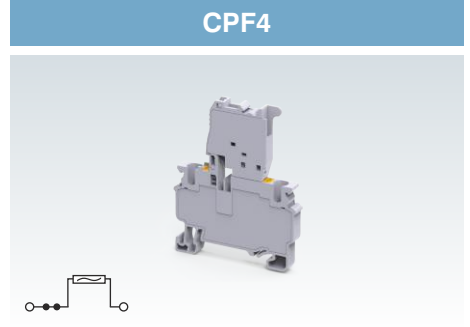

	Type / Cat. No.	Standard Pack
Terminal Block for Ø5 x 20 mm Fuse	Grey	CPF4 50
	With LED for 6-60 V AC/DC	CPF4L6-60V 50
	With LED for 110-240 V AC/DC	CPF4L110-240V 50
Partition Plate	PPCX4/3	50
Mounting Rail (Refer Pg. 263 for details)	CA701-1M / CA701-1M-S	50 m
	CA701-15-1M / CA701-15-1M-S	25 m
End Clamp (Refer Pg. 264 for details)	CA103 / CA104	50
Marking Tags (Refer Pg. 268 for details)	CA509/K6WHT	100
Marker Card (Refer Pg. 269 for details)	MC6	10
Screw Driver	SCM0.5/3 Blade size: 0.5 x 3mm	10

	Type / Cat. No.	I _{max}	Standard Pack
Jumpers	2 pole	JX4/2	32 A 100
	3 pole	JX4/3	32 A 50
	4 pole	JX4/4	32 A 50
	5 pole	JX4/5	32 A 10
	6 pole	JX4/6	32 A 10
	8 pole	JX4/8	32 A 10
	10 pole	JX4/10	32 A 10
	16 pole	JX4/16	32 A 10
Step Down Jumpers	6 - 2.5 mm ² 6 - 4 mm ²	JXS6/2.5	32 A 50

CPF6

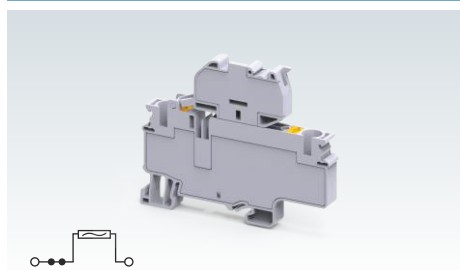

8 x 82.9 mm
67.1 mm / 74.6 mm

IEC	UL - CSA
0.5 - 10.0 mm ²	20 - 8 AWG
0.5 - 10.0 mm ²	
0.5 - 10.0 mm ²	20 - 8 AWG
0.5 - 2.5 mm ²	20 - 14 AWG

12 mm
IEC60947-7-3 UL-1059 CSA22.2-158 IEC60079-7

1000 V	600 V	600 V	630 V
16 A	16 A	10 A	6.3 A

CE
Polyamide 6,6 / 1
4 KV / 3

Type / Cat. No.	Standard Pack
CPF6	50
CPF6L6-60V	50
CPF6L110-240V	50
CA701-1M / CA701-1M-S	50 m
CA701-15-1M / CA701-15-1M-S	25 m
CA103 / CA104	50
CA509/K8WHT / CA509/K2B4WHT	100
MC8 / MC2B4	10
SCM0.8/4 Blade size: 0.8 x 4 mm	10

Type / Cat. No.	I _{max}	Standard Pack
JX6/2	41 A	100
JX6/3	41 A	50
JX6/4	41 A	50
JX6/5	41 A	50
JX6/10	41 A	10
JXS6/2.5	41 A	50
JXS6/4	41 A	50

CPDLF2.5

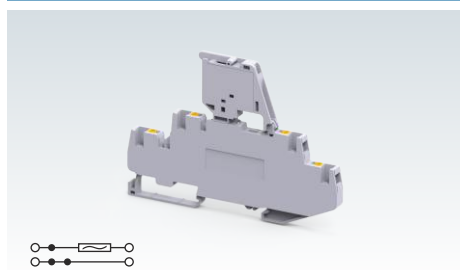

6 x 107.3 mm
77.8 mm / 85.2 mm

IEC	UL - CSA
0.2 - 4.0 mm ²	24 - 10 AWG
0.2 - 6.0 mm ²	
0.2 - 4.0 mm ²	24 - 10 AWG
0.5 - 1.0 mm ²	20 - 18 AWG

10 mm
IEC60947-7-3 UL-1059 CSA22.2-158 IEC60079-7

500 V	300 V	300 V	630 V
6.3 A	6.3 A	6.3 A	6.3 A

IEC CE UL
Polyamide 6,6 / 1
4 KV / 3

Type / Cat. No.	Standard Pack
CPDLF2.5	50
CPDLF2.5L6-60V	50
CPDLF2.5L110-240V	50
CA701-1M / CA701-1M-S	50 m
CA701-15-1M / CA701-15-1M-S	25 m
CA103 / CA104	50
CA509/K6WHT / CA509/K2B4WHT	100
MC6 / MC2B4	10
SCM0.5/3 Blade size: 0.5 x 3 mm	10

Type / Cat. No.	I _{max}	Standard Pack
JX4/2	32 A	100
JX4/3	32 A	50
JX4/4	32 A	50
JX4/5	32 A	10
JX4/6	32 A	10
JX4/8	32 A	10
JX4/10	32 A	10
JX4/16	32 A	10

CPDLFK2.5

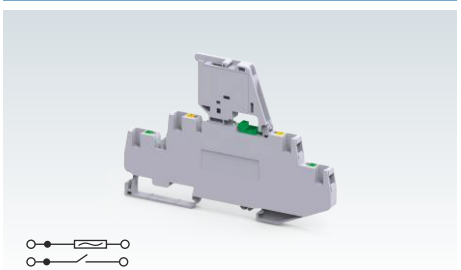

6 x 107.3 mm
77.8 mm / 85.2 mm

IEC	UL - CSA
0.2 - 4.0 mm ²	24 - 10 AWG
0.2 - 6.0 mm ²	
0.2 - 4.0 mm ²	24 - 10 AWG
0.5 - 1.0 mm ²	20 - 18 AWG

10 mm
IEC60947-7-3 UL-1059 CSA22.2-158 IEC60079-7

500 V	300 V	300 V	630 V
6.3 A	6.3 A	6.3 A	6.3 A

IEC CE UL
Polyamide 6,6 / 1
4 KV / 3

Type / Cat. No.	Standard Pack
CPDLFK2.5	50
CPDLFK2.5L6-60V	50
CPDLFK2.5L110-240V	50
CA701-1M / CA701-1M-S	50 m
CA701-15-1M / CA701-15-1M-S	25 m
CA103 / CA104	50
CA509/K6WHT / CA509/K2B4WHT	100
MC6 / MC2B4	10
SCM0.5/3 Blade size: 0.5 x 3 mm	10

Type / Cat. No.	I _{max}	Standard Pack
JX4/2	32 A	100
JX4/3	32 A	50
JX4/4	32 A	50
JX4/5	32 A	10
JX4/6	32 A	10
JX4/8	32 A	10
JX4/10	32 A	10
JX4/16	32 A	10

FUSE TERMINAL BLOCKS

CPF4RO

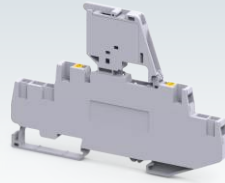

CPAF6

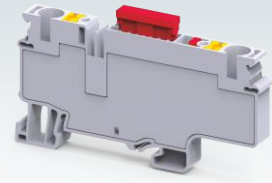

Width (Thickness) x Length	6 x 54.8 mm	
Height with DIN 35 x 7.5 / 35 x 15 mm Rail	68.8 mm / 76.3 mm	
Connection Possibility as per	IEC	
With 1 Conductor per clamp	Stranded / Flexible	0.2 - 4.0 mm ²
	Solid	0.2 - 6.0 mm ²
	with Ferrule / Lug	0.2 - 4.0 mm ²
With 2 same size Conductors per clamp	with TWIN Ferrule / Lug	0.5 - 1.0 mm ²
Wire Stripping Length	10 mm	
Ratings As Per	IEC60947-7-3	UL-1059
Voltage	500 V	300 V
Current	6.3 A	6.3 A
Approval		
Insulation Material / Material Group	Polyamide 6,6 / 1	
Rated Impulse Voltage / Pollution Degree	4 KV / 3	

Width (Thickness) x Length	8 x 82.9 mm	
Height with DIN 35 x 7.5 / 35 x 15 mm Rail	43 mm / 50.5 mm	
Connection Possibility as per	IEC	
With 1 Conductor per clamp	Stranded / Flexible	0.5 - 10.0 mm ²
	Solid	0.5 - 10.0 mm ²
	with Ferrule / Lug	0.5 - 10.0 mm ²
With 2 same size Conductors per clamp	with TWIN Ferrule / Lug	0.5 - 2.5 mm ²
Wire Stripping Length	12 mm	
Ratings As Per	IEC60947-7-3	UL-1059
Voltage	1000 V	600 V
Current	30 A	30 A
Approval		
Insulation Material / Material Group	Polyamide 6,6 / 1	
Rated Impulse Voltage / Pollution Degree	6 KV / 3	

Width (Thickness) x Length	8 x 82.9 mm	
Height with DIN 35 x 7.5 / 35 x 15 mm Rail	43 mm / 50.5 mm	
Connection Possibility as per	IEC	
With 1 Conductor per clamp	Stranded / Flexible	0.5 - 10.0 mm ²
	Solid	0.5 - 10.0 mm ²
	with Ferrule / Lug	0.5 - 10.0 mm ²
With 2 same size Conductors per clamp	with TWIN Ferrule / Lug	0.5 - 2.5 mm ²
Wire Stripping Length	12 mm	
Ratings As Per	IEC60947-7-3	UL-1059
Voltage	1000 V	600 V
Current	30 A	30 A
Approval		
Insulation Material / Material Group	Polyamide 6,6 / 1	
Rated Impulse Voltage / Pollution Degree	6 KV / 3	

Terminal Block for Ø5 x 20 mm Fuse	Grey	CPF4RO	50
	With LED for 6-60 V AC/DC	CPF4ROL6-60V	50
	With LED for 110-240 V AC/DC	CPF4ROL110-240V	50
	With LED for 12 V AC/DC		
	With LED for 24 V AC/DC		
Mounting Rail (Refer Pg. 263 for details)		CA701-1M / CA701-1M-S	50 m
End Clamp (Refer Pg. 264 for details)		CA701-15-1M / CA701-15-1M-S	25 m
Marking Tags (Refer Pg. 268 for details)		CA103 / CA104	50
Marker Card (Refer Pg. 269 for details)		CA509/K2B4WHT	100
Screw Driver		MC2B4	10
		SCM0.5/3 Blade size: 0.5 x 3 mm	10

Type / Cat. No.	Standard Pack	Type / Cat. No.	Standard Pack
CPF4RO	50	CPAF6	50
CPF4ROL6-60V	50	CPAF6L12V	50
CPF4ROL110-240V	50	CPAF6L24V	50
CA701-1M / CA701-1M-S	50 m	CA701-1M / CA701-1M-S	50 m
CA701-15-1M / CA701-15-1M-S	25 m	CA701-15-1M / CA701-15-1M-S	25 m
CA103 / CA104	50	CA103 / CA104	50
CA509/K2B4WHT	100	CA509/K8WHT	100
MC2B4	10	MC8	10
SCM0.5/3 Blade size: 0.5 x 3 mm	10	SCM0.8/4 Blade size: 0.8 x 4 mm	10

Type / Cat. No.	Standard Pack	Type / Cat. No.	Standard Pack
CPAF6	50	CPAF6	50
CPAF6L12V	50	CPAF6L12V	50
CPAF6L24V	50	CPAF6L24V	50
CA701-1M / CA701-1M-S	50 m	CA701-1M / CA701-1M-S	50 m
CA701-15-1M / CA701-15-1M-S	25 m	CA701-15-1M / CA701-15-1M-S	25 m
CA103 / CA104	50	CA103 / CA104	50
CA509/K8WHT	100	CA509/K8WHT	100
MC8	10	MC8	10
SCM0.8/4 Blade size: 0.8 x 4 mm	10	SCM0.8/4 Blade size: 0.8 x 4 mm	10

Jumpers	Type / Cat. No.	I _{max}	Standard Pack
Pluggable Jumpers	2 pole	JX4/2	32 A
	3 pole	JX4/3	32 A
	4 pole	JX4/4	32 A
	5 pole	JX4/5	32 A
	6 pole	JX4/6	32 A
	8 pole	JX4/8	32 A
	10 pole	JX4/10	32 A
	16 pole	JX4/16	32 A
Step Down Jumpers	6 - 2.5 mm ² 6 - 4 mm ²		

Type / Cat. No.	I _{max}	Standard Pack	Type / Cat. No.	I _{max}	Standard Pack
JX4/2	32 A	100	JX6/2	41 A	100
JX4/3	32 A	50	JX6/3	41 A	50
JX4/4	32 A	50	JX6/4	41 A	50
JX4/5	32 A	10	JX6/5	41 A	50
JX4/6	32 A	10			
JX4/8	32 A	10			
JX4/10	32 A	10	JX6/10	41 A	10
JX4/16	32 A	10			
			JXS6/2.5	41 A	50
			JXS6/4	41 A	50

Type / Cat. No.	I _{max}	Standard Pack	Type / Cat. No.	I _{max}	Standard Pack
JX6/2	41 A	100	JX6/2	41 A	100
JX6/3	41 A	50	JX6/3	41 A	50
JX6/4	41 A	50	JX6/4	41 A	50
JX6/5	41 A	50	JX6/5	41 A	50
			JX6/10	41 A	10
			JXS6/2.5	41 A	50
			JXS6/4	41 A	50

DISCONNECT & TEST TERMINAL BLOCKS

CPK series terminals are compact Disconnect Push-In connection Terminal Blocks.

In these Terminal Blocks disconnection is achieved by opening the insulated knife (blade) contact in the middle of the terminal.

Separate testing points are provided on top for inserting standard Ø2.3 mm test probes.

Alternate and continuous bridging can be done with standard pluggable jumpers.

CPK2.5

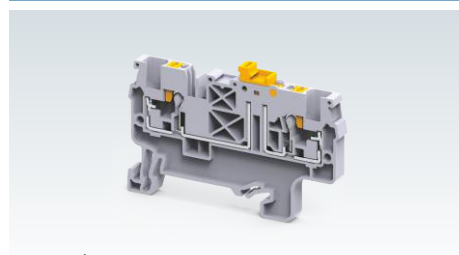

Width (Thickness) x Length	5 x 62.5 mm			
Height with DIN 35 x 7.5 / 35 x 15 mm Rail	38.2 mm / 45.7 mm			
Connection Possibility as per	IEC		UL - CSA	
With 1 Conductor per clamp	Stranded / Flexible	0.2 - 2.5 mm ²	24 - 12 AWG	
	Solid	0.2 - 4.0 mm ²	24 - 10 AWG	
	with Ferrule / Lug	0.2 - 2.5 mm ²	24 - 12 AWG	
With 2 same size Conductors per clamp	with TWIN Ferrule / Lug	0.5 mm ²	20 AWG	
Wire Stripping Length	10 mm			
Ratings As Per	IEC60947-7-1	UL-1059	CSA22.2-158	IEC60079-7
Voltage	1000 V	600 V	600 V	630 V
Current	20 A	16 A	16 A	17 A
Approval				
Insulation Material / Material Group	Polyamide 6,6 / 1			
Rated Impulse Voltage / Pollution Degree	6 KV / 3			

	Type / Cat. No.	Standard Pack	
Terminal Block	Grey	CPK2.5	100
	Blue	CPK2.5BU	100
End Plate	EPCX2.5/3	50	
Partition Plate	PPCX4/3	50	
Mounting Rail (Refer Pg. 263 for details)	CA701-1M / CA701-1M-S	50 m	
	CA701-15-1M / CA701-15-1M-S	25 m	
End Clamp (Refer Pg. 264 for details)	CA103 / CA104	50	
Warning Label			
Marking Tags (Refer Pg. 268 for details)	MS5WHT	100	
Disconnecting Marker	CA509/K4WHT	100	
Marker Card (Refer Pg. 269 for details)			
Screw Driver	SCM0.5/3 Blade size: 0.5 x 3 mm	10	

	Type / Cat. No.	I _{max}	Standard Pack	
Pluggable Jumpers	2 pole	JX2.5/2	24 A	100
	3 pole	JX2.5/3	24 A	50
	4 pole	JX2.5/4	24 A	50
	5 pole	JX2.5/5	24 A	50
	6 pole	JX2.5/6	24 A	10
	7 pole	JX2.5/7	24 A	10
	8 pole	JX2.5/8	24 A	10
	10 pole	JX2.5/10	24 A	10
	20 pole	JX2.5/20	24 A	10
	Step Down Jumpers	JXS6/2.5	41 A	50
Test Plug	TX2.5		20	

DISCONNECT & TEST TERMINAL BLOCKS

CPK4

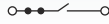

CPK6

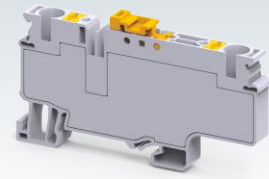

Width (Thickness) x Length	6 x 54.8 mm	
Height with DIN 35 x 7.5 / 35 x 15 mm Rail	42.4 mm / 49.9 mm	
Connection Possibility as per	IEC	
With 1 Conductor per clamp	Stranded / Flexible	0.2 - 4.0 mm ²
	Solid	0.2 - 6.0 mm ²
	with Ferrule / Lug	0.2 - 4.0 mm ²
With 2 same size Conductors per clamp	with TWIN Ferrule / Lug	0.5 - 1.0 mm ²
Wire Stripping Length	10 mm	
Ratings As Per	IEC60947-7-3	UL-1059
Voltage	1000 V	600 V
	600 V	630 V
Current	20 A	18 A
	20 A	20 A
Approval		
Insulation Material / Material Group	Polyamide 6,6 / 1	
Rated Impulse Voltage / Pollution Degree	8 KV / 3	

6 x 54.8 mm	
42.4 mm / 49.9 mm	
IEC	
UL - CSA	
0.2 - 4.0 mm ²	24 - 10 AWG
0.2 - 6.0 mm ²	
0.2 - 4.0 mm ²	24 - 10 AWG
0.5 - 1.0 mm ²	20 - 18 AWG
10 mm	
IEC60947-7-3	UL-1059
1000 V	600 V
600 V	630 V
20 A	18 A
20 A	20 A
Polyamide 6,6 / 1	
8 KV / 3	

8 x 82.9 mm	
43 mm / 50.5 mm	
IEC	
UL - CSA	
0.5 - 10.0 mm ²	20 - 8 AWG
0.5 - 10.0 mm ²	
0.5 - 10.0 mm ²	20 - 8 AWG
0.5 - 2.5 mm ²	20 - 14 AWG
12 mm	
IEC60947-7-1	UL-1059
1000 V	600 V
600 V	
20 A	20 A
Polyamide 6,6 / 1	
6 KV / 3	

Terminal Block	Grey Blue	Type / Cat. No.	Standard Pack
End Plate		CPK4 CPK4BU	50 50
Partition Plate		PPCX4 / PPCX4/4	50
Mounting Rail (Refer Pg. 263 for details)		CA701-1M / CA701-1M-S CA701-15-1M / CA701-15-1M-S	50 m 25 m
End Clamp (Refer Pg. 264 for details)		CA103 / CA104	50
Warning Label			
Marking Tags (Refer Pg. 268 for details)		CA509/K6WHT	100
Disconnecting Marker		CA509/K4WHT	100
Marker Card (Refer Pg. 269 for details)		MC6	10
Screw Driver		SCM0.5/3	Blade size: 0.5 x 3 mm 10

Type / Cat. No.	Standard Pack
CPK4 CPK4BU	50 50
PPCX4 / PPCX4/4	50
CA701-1M / CA701-1M-S CA701-15-1M / CA701-15-1M-S	50 m 25 m
CA103 / CA104	50
CA509/K6WHT	100
CA509/K4WHT	100
MC6	10
SCM0.5/3	Blade size: 0.5 x 3 mm 10

Type / Cat. No.	Standard Pack
CPK6	50
CA701-1M / CA701-1M-S CA701-15-1M / CA701-15-1M-S	50 m 25 m
CA103 / CA104	50
CA509/K8WHT	100
CA509/K2B4WHT	100
MC8 / MC2B4	10
SCM0.8/4	Blade size: 0.8 x 4 mm 10

Jumpers	Type / Cat. No.	I _{max}	Standard Pack
Pluggable Jumpers	2 pole	JX4/2	32 A 100
	3 pole	JX4/3	32 A 50
	4 pole	JX4/4	32 A 50
	5 pole	JX4/5	32 A 10
	6 pole	JX4/6	32 A 10
	8 pole	JX4/8	32 A 10
	10 pole	JX4/10	32 A 10
	16 pole	JX4/16	32 A 10
Step Down Jumpers	JXS6/4	41 A	50
Test Plug			

Type / Cat. No.	I _{max}	Standard Pack
JX4/2	32 A	100
JX4/3	32 A	50
JX4/4	32 A	50
JX4/5	32 A	10
JX4/6	32 A	10
JX4/8	32 A	10
JX4/10	32 A	10
JX4/16	32 A	10
JXS6/4	41 A	50

Type / Cat. No.	I _{max}	Standard Pack
JX6/2	41 A	100
JX6/3	41 A	50
JX6/4	41 A	50
JX6/5	41 A	50
JX6/10	41 A	10
JXS6/2.5	41 A	50
JXS6/4	41 A	50

DISCONNECTING TERMINAL BLOCKS

CPDLK series terminals are double level disconnect Terminal Blocks.

In these Terminal Blocks disconnection is achieved by opening the insulated knife (blade) contact. The disconnecting knife is appropriately colour coded to ensure error free disconnection of the correct circuit.

CPDLK2.5 Terminal Blocks offer disconnection separately for both top and bottom levels.

CPDLK2.5(I.S) Terminal Block is internally shorted, offering single potential for all 4 connection points.

CPDLKFT2.5 is double level Terminal Block with a disconnecting lever on the top level and a feed through system on the bottom level.

CPDLKFT2.5(I.S) offer similar configuration with top and bottom level internally shorted.

Alternate and continuous bridging can be done with standard pluggable jumpers.

CPDLK2.5

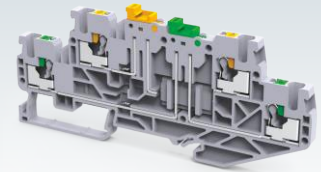

Width (Thickness) x Length	5 x 107.3 mm			
Height with DIN 35 x 7.5 / 35 x 15 mm Rail	50 mm / 57.5 mm			
Connection Possibility as per	IEC		UL - CSA	
With 1 Conductor per clamp	Stranded / Flexible	0.2 - 2.5 mm ²	24 - 12 AWG	
		0.2 - 4.0 mm ²	24 - 10 AWG	
	Solid with Ferrule / Lug	0.2 - 2.5 mm ²	24 - 12 AWG	
With 2 same size Conductors per clamp	with TWIN Ferrule / Lug	0.5 mm ²	20 AWG	
Wire Stripping Length	10 mm			
Ratings As Per	IEC60947-7-1	UL-1059	CSA22.2-158	IEC60079-7
Voltage	500 V	300 V	300 V	630 V
Current	16 A	14 A	14 A	12 A
Approval				
Insulation Material / Material Group	Polyamide 6,6 / 1			
Rated Impulse Voltage / Pollution Degree	6 KV / 3			

		Type / Cat. No.	Standard Pack		
Terminal Block	Grey	CPDLK2.5	50		
End Plate		EPCPDLK2.5	50		
Mounting Rail (Refer Pg. 263 for details)		CA701-1M / CA701-1M-S	50 m		
End Clamp (Refer Pg. 264 for details)		CA701-15-1M / CA701-15-1M-S	25 m		
End Clamp		CA103 / CA104	50		
Marking Tags (Refer Pg. 268 for details)		MS5WHT	100		
Marking Tags For Knife Contact		CA509/K4WHT	100		
Screw Driver		SCM0.5/3 Blade size: 0.5 x 3 mm	10		
Jumpers		Type / Cat. No.	Imax	Standard Pack	
Pluggable Jumpers		2 pole	JX2.5/2	24 A	100
		3 pole	JX2.5/3	24 A	50
		4 pole	JX2.5/4	24 A	50
		5 pole	JX2.5/5	24 A	50
		6 pole	JX2.5/6	24 A	10
		7 pole	JX2.5/7	24 A	10
		8 pole	JX2.5/8	24 A	10
		10 pole	JX2.5/10	24 A	10
		20 pole	JX2.5/20	24 A	10

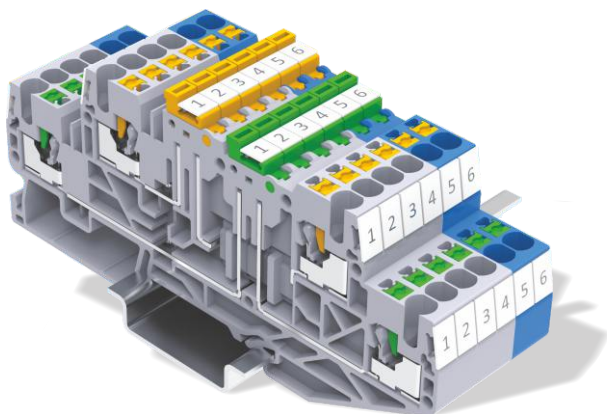

CPDLK2.5(I.S)

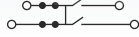
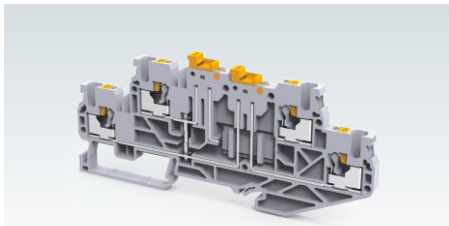

CPDLKFT2.5

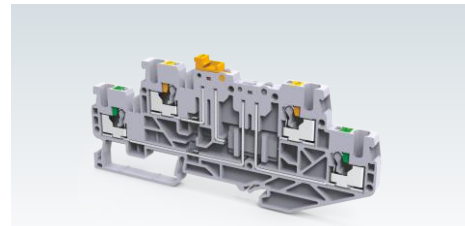

Width (Thickness) x Length		5 x 107.3 mm	
Height with DIN 35 x 7.5 / 35 x 15 mm Rail		50 mm / 57.5 mm	
Connection Possibility as per		IEC	
With 1 Conductor per clamp	Stranded / Flexible	0.2 - 2.5 mm ²	
	Solid	0.2 - 4.0 mm ²	
	with Ferrule / Lug	0.2 - 2.5 mm ²	
With 2 same size Conductors per clamp	with TWIN Ferrule / Lug	0.5 mm ²	
Wire Stripping Length		10 mm	
Ratings As Per		IEC60947-7-1 UL-1059 CSA22.2-158	
Voltage		500 V	300 V
Current		16 A	14 A
Approval			
Insulation Material / Material Group		Polyamide 6,6 / 1	
Rated Impulse Voltage / Pollution Degree		6 KV / 3	

Width (Thickness) x Length		5 x 107.3 mm	
Height with DIN 35 x 7.5 / 35 x 15 mm Rail		50 mm / 57.5 mm	
Connection Possibility as per		IEC	
With 1 Conductor per clamp	Stranded / Flexible	0.2 - 2.5 mm ²	
	Solid	0.2 - 4.0 mm ²	
	with Ferrule / Lug	0.2 - 2.5 mm ²	
With 2 same size Conductors per clamp	with TWIN Ferrule / Lug	0.5 mm ²	
Wire Stripping Length		10 mm	
Ratings As Per		IEC60947-7-1 UL-1059 CSA22.2-158	
Voltage		500 V	300 V
Current		16 A	14 A
Approval			
Insulation Material / Material Group		Polyamide 6,6 / 1	
Rated Impulse Voltage / Pollution Degree		6 KV / 3	

Width (Thickness) x Length		5 x 107.3 mm	
Height with DIN 35 x 7.5 / 35 x 15 mm Rail		50 mm / 57.5 mm	
Connection Possibility as per		IEC	
With 1 Conductor per clamp	Stranded / Flexible	0.2 - 2.5 mm ²	
	Solid	0.2 - 4.0 mm ²	
	with Ferrule / Lug	0.2 - 2.5 mm ²	
With 2 same size Conductors per clamp	with TWIN Ferrule / Lug	0.5 mm ²	
Wire Stripping Length		10 mm	
Ratings As Per		IEC60947-7-1 UL-1059 CSA22.2-158	
Voltage		500 V	300 V
Current		16 A	14 A
Approval			
Insulation Material / Material Group		Polyamide 6,6 / 1	
Rated Impulse Voltage / Pollution Degree		6 KV / 3	

Terminal Block	Grey	CPDLK2.5(I.S)	50
End Plate		EPCPDLK2.5	50
Mounting Rail (Refer Pg. 263 for details)		CA701-1M / CA701-1M-S	50 m
End Clamp (Refer Pg. 264 for details)		CA701-15-1M / CA701-15-1M-S	25 m
Marking Tags (Refer Pg. 268 for details)		CA103 / CA104	50
Marking Tags For Knife Contact		MS5WHT	100
Screw Driver		CA509/K4WHT	100
		SCM0.5/3 Blade size: 0.5 x 3 mm	10

Type / Cat. No.	Standard Pack	Type / Cat. No.	Standard Pack
CPDLK2.5(I.S)	50	CPDLKFT2.5	50
EPCPDLK2.5	50	EPCPDLK2.5	50
CA701-1M / CA701-1M-S	50 m	CA701-1M / CA701-1M-S	50 m
CA701-15-1M / CA701-15-1M-S	25 m	CA701-15-1M / CA701-15-1M-S	25 m
CA103 / CA104	50	CA103 / CA104	50
MS5WHT	100	MS5WHT	100
CA509/K4WHT	100	CA509/K4WHT	100
SCM0.5/3 Blade size: 0.5 x 3 mm	10	SCM0.5/3 Blade size: 0.5 x 3 mm	10

Type / Cat. No.	Standard Pack	Type / Cat. No.	Standard Pack
CPDLK2.5(I.S)	50	CPDLKFT2.5	50
EPCPDLK2.5	50	EPCPDLK2.5	50
CA701-1M / CA701-1M-S	50 m	CA701-1M / CA701-1M-S	50 m
CA701-15-1M / CA701-15-1M-S	25 m	CA701-15-1M / CA701-15-1M-S	25 m
CA103 / CA104	50	CA103 / CA104	50
MS5WHT	100	MS5WHT	100
CA509/K4WHT	100	CA509/K4WHT	100
SCM0.5/3 Blade size: 0.5 x 3 mm	10	SCM0.5/3 Blade size: 0.5 x 3 mm	10

Pluggable Jumpers		2 pole	JX2.5/2	24 A	100
		3 pole	JX2.5/3	24 A	50
		4 pole	JX2.5/4	24 A	50
		5 pole	JX2.5/5	24 A	50
		6 pole	JX2.5/6	24 A	10
		7 pole	JX2.5/7	24 A	10
		8 pole	JX2.5/8	24 A	10
		10 pole	JX2.5/10	24 A	10
		20 pole	JX2.5/20	24 A	10

Type / Cat. No.	Imax	Standard Pack	Type / Cat. No.	Imax	Standard Pack
JX2.5/2	24 A	100	JX2.5/2	24 A	100
JX2.5/3	24 A	50	JX2.5/3	24 A	50
JX2.5/4	24 A	50	JX2.5/4	24 A	50
JX2.5/5	24 A	50	JX2.5/5	24 A	50
JX2.5/6	24 A	10	JX2.5/6	24 A	10
JX2.5/7	24 A	10	JX2.5/7	24 A	10
JX2.5/8	24 A	10	JX2.5/8	24 A	10
JX2.5/10	24 A	10	JX2.5/10	24 A	10
JX2.5/20	24 A	10	JX2.5/20	24 A	10

Type / Cat. No.	Imax	Standard Pack	Type / Cat. No.	Imax	Standard Pack
JX2.5/2	24 A	100	JX2.5/2	24 A	100
JX2.5/3	24 A	50	JX2.5/3	24 A	50
JX2.5/4	24 A	50	JX2.5/4	24 A	50
JX2.5/5	24 A	50	JX2.5/5	24 A	50
JX2.5/6	24 A	10	JX2.5/6	24 A	10
JX2.5/7	24 A	10	JX2.5/7	24 A	10
JX2.5/8	24 A	10	JX2.5/8	24 A	10
JX2.5/10	24 A	10	JX2.5/10	24 A	10
JX2.5/20	24 A	10	JX2.5/20	24 A	10

CPDLKFT2.5(I.S)

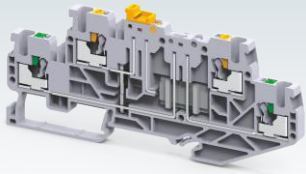

5 x 107.3 mm

50 mm / 57.5 mm

IEC	UL - CSA
0.2 - 2.5 mm ²	24 - 12 AWG
0.2 - 4.0 mm ²	24 - 10 AWG
0.2 - 2.5 mm ²	24 - 12 AWG

0.5 mm² 20 AWG

10 mm

IEC60947-7-1 UL-1059

500 V	300 V		
16 A	14 A		



Polyamide 6,6 / 1

6 KV / 3

Type / Cat. No.	Standard Pack
CPDLKFT2.5(I.S)	50
EPCPDLK2.5	50
CA701-1M / CA701-1M-S	50 m
CA701-15-1M / CA701-15-1M-S	25 m
CA103 / CA104	50
MS5WHT	100
CA509/K4WHT	100
SCM0.5/3 Blade size: 0.5 x 3 mm	10

Type / Cat. No.	I _{max}	Standard Pack
JX2.5/2	24 A	100
JX2.5/3	24 A	50
JX2.5/4	24 A	50
JX2.5/5	24 A	50
JX2.5/6	24 A	10
JX2.5/7	24 A	10
JX2.5/8	24 A	10
JX2.5/10	24 A	10
JX2.5/20	24 A	10

TERMINAL BLOCKS WITH ELECTRONIC COMPONENTS





These are electronic Push-In Double Level Terminal Blocks with built in diodes and LED.

The built in diode acts as a free wheeling diode which is connected across the inductive load such as relay coils, solenoid valves, contactor coils to eliminate or suppress sudden voltage spike which appears across the load when its supply voltage is removed.

CPDL2.5(E)LD1 Terminal Block has a built in LED circuit for online indication.

CPDL2.5(E)D* is specially designed 4 wire spring clamp Terminal Block with a built in diode. This Terminal has a built in 1N4007 diode for reverse polarity protection and also allows uni directional flow of current.

Width (Thickness) x Length	5 x 72.7 mm		
Height with DIN 35 x 7.5 / 35 x 15 mm Rail	49.5 mm / 57 mm		
Connection Possibility as per	IEC	UL - CSA	
With 1 Conductor per clamp	Stranded / Flexible	0.2 - 2.5 mm ²	24 - 12 AWG
	Solid	0.2 - 4.0 mm ²	24 - 10 AWG
	with Ferrule / Lug	0.2 - 2.5 mm ²	24 - 12 AWG
With 2 same size Conductors per clamp	with TWIN Ferrule / Lug	0.5 mm ²	20 AWG
Wire Stripping Length	10 mm		
Ratings As Per	IEC60947-7-1	UL-1059	
Voltage	1000 V	600 V	
Current	*	*	
Approval			
Insulation Material / Comparative Tracking Index	Polyamide 66 / 1		
Rated Impulse Voltage / Pollution Degree	8 KV / 3		

	Type / Cat. No.	Standard Pack
End Plate 	EPCXDL2.5	50
Mounting Rail (Refer Pg. 263 for details) 	CA701-1M / CA701-1M-S	50 m
End Clamp (Refer Pg. 264 for details) 	CA701-15-1M / CA701-15-1M-S	25 m
Warning Label		
Marking Tags (Refer Pg. 268 for details) 	CA509/K5WHT	100
Marker Card (Refer Pg. 269 for details)	MC5	10
Screw Driver 	SCM0.5/3 Blade size: 0.5 x 3.0 mm	10
Dual Marker Carrier	TM5	50

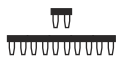
Jumpers	Type / Cat. No.	I _{max}	Standard Pack	
Pluggable Jumpers 	2 pole	JX2.5/2	24 A	100
	3 pole	JX2.5/3	24 A	50
	4 pole	JX2.5/4	24 A	50
	5 pole	JX2.5/5	24 A	50
	6 pole	JX2.5/6	24 A	10
	7 pole	JX2.5/7	24 A	10
	8 pole	JX2.5/8	24 A	10
	10 pole	JX2.5/10	24 A	10
	20 pole	JX2.5/20	24 A	10
Test Plug	TX2.5		20	

Part No.	Application	Std. Pack
CPDL2.5(E)D1	Arc suppression circuit for contactors & solenoid valves - D.C	50

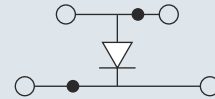
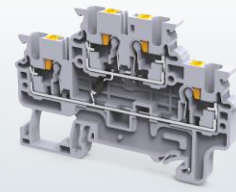

Part No.	Application	Std. Pack
CPDL2.5(E)D2	Arc suppression circuit for contactors & solenoid valves - D.C	50

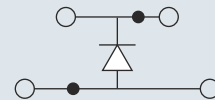
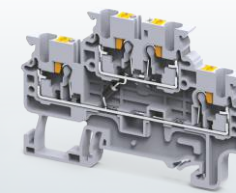

Part No.	Application	Std. Pack
CPDL2.5(E)D3	Diode circuit for reverse polarity protection	50

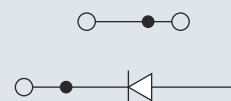
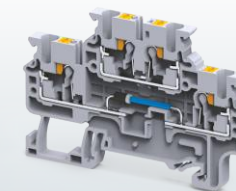

Part No.	Application	Std. Pack
CPDL2.5(E)DD1	Diode circuit for lamp testing	50

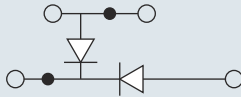
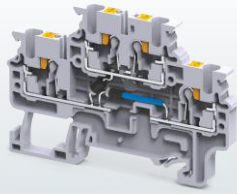

Part No.	Application	Std. Pack
CPDL2.5(E)DD2	Diode circuit for lamp testing	50

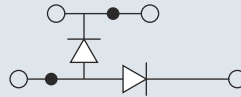
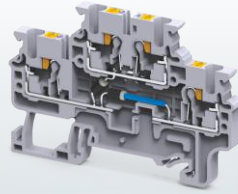

Part No.	Application	Std. Pack
CPDL2.5(E)DD3	Diode circuit for lamp testing	50

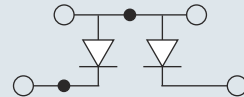
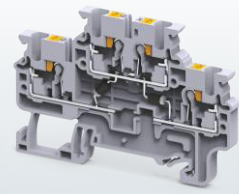

Part No.	Application	Std. Pack
CPDL2.5(E)DD4	Diode circuit for lamp testing	50

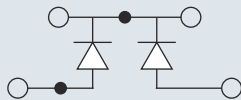
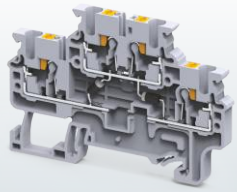

Part No.	Application	Std. Pack
CPDL2.5(E)DD5	Diode circuit for lamp testing	50

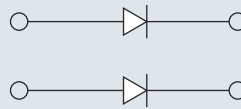
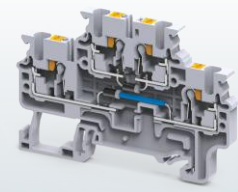

Part No.	Application	Std. Pack
CPDL2.5(E)DD6	Diode circuit for lamp testing	50

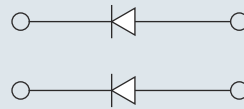
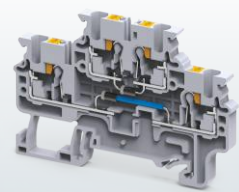

Part No.	Application	Std. Pack
CPDL2.5(E)LD1	DC Voltage indicator with LED	50

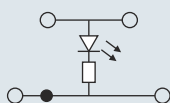
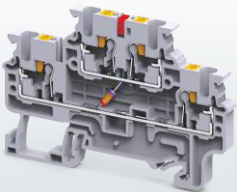

Part No.	Application	Std. Pack
CPDL2.5(E)TS1	Temperature sensor for measuring temperature	50

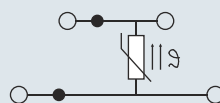
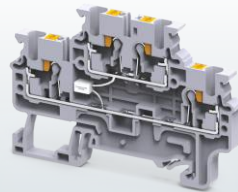

TERMINAL BLOCKS WITH ELECTRONIC COMPONENTS





These are electronic series spring clamp double level Terminal Blocks with built in diodes and LED.

The built in diode acts as a free wheeling diode which is connected across the inductive load such as relay coils, solenoid valves, contactor coils to eliminate or suppress sudden voltage spike which appears across the load when its supply voltage is removed.

CP4/4(E)* Terminal Block has a built in LED circuit for online indication.

CP4/4(E)* is specially designed 4 wire spring clamp Terminal Block with a built in diode. This Terminal has a built in 1N4007 diode for reverse polarity protection and also allows uni directional flow of current.

Width (Thickness) x Length	6 x 84.5 mm		
Height with DIN 35 x 7.5 / 35 x 15 mm Rail	38.2 mm / 45.7 mm		
Connection Possibility as per	IEC	UL - CSA	
With 1 Conductor per clamp	Stranded / Flexible	0.2 - 4.0 mm ²	24 - 10 AWG
	Solid with Ferrule / Lug	0.2 - 6.0 mm ² 0.2 - 4.0 mm ²	24 - 12 AWG
With 2 same size Conductors per clamp	with TWIN Ferrule / Lug	0.5 - 1.0 mm ²	20 - 18 AWG
Wire Stripping Length	11 mm		
Ratings As Per	IEC60947-7-1	UL-1059	
Voltage	1000 V	600 V	
Current	*	*	
Approval			
Insulation Material / Comparative Tracking Index	Polyamide 66 / 1		
Rated Impulse Voltage / Pollution Degree	8 KV / 3		

	Type / Cat. No.	Standard Pack
End Plate 	EPCX4/4	50
Partition Plate	PPCX4/4	20
Mounting Rail (Refer Pg. 263 for details) 	CA701-1M / CA701-1M-S	50 m
	CA701-15-1M / CA701-15-1M-S	25 m
End Clamp (Refer Pg. 264 for details) 	CA103 / CA104	50
Marking Tags (Refer Pg. 268 for details) 	CA509/K6WHT	100
Marker Card (Refer Pg. 269 for details)	MC6	10
Screw Driver 	SCM0.6/3.5 Blade size: 0.6 x 3.5 mm	10

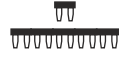
	Type / Cat. No.	I _{max}	Standard Pack
Pluggable Jumpers 	2 pole	JX4/2	32 A 100
	3 pole	JX4/3	32 A 50
	4 pole	JX4/4	32 A 50
	5 pole	JX4/5	32 A 10
	6 pole	JX4/6	32 A 10
	8 pole	JX4/8	32 A 10
	10 pole	JX4/10	32 A 10
	16 pole	JX4/16	32 A 10

Note: Jumpers only suitable for CP4/4(E)D1 and CP4/4(E)D2

Part No.	Application	Std. Pack
CP4/4(E)D1	Arc suppression circuit for contactors & solenoid valves - D.C	100
CP4/4(E)D2		100

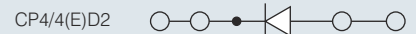
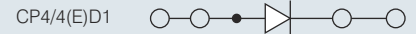
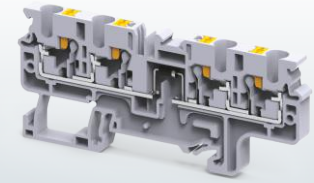

Part No.	Application	Std. Pack
CP4/4(E)D3	Arc suppression circuit for contactors & solenoid valves - D.C	100
CP4/4(E)D4		100

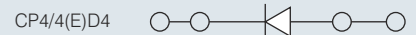
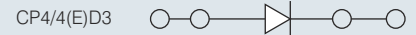
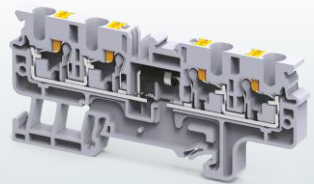

Part No.	Application	Std. Pack
CP4/4(E1)D3	Arc suppression circuit for contactors & solenoid valves - D.C	100
CP4/4(E1)D4		100

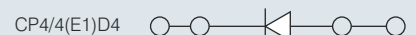
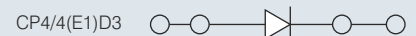
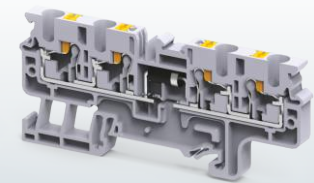

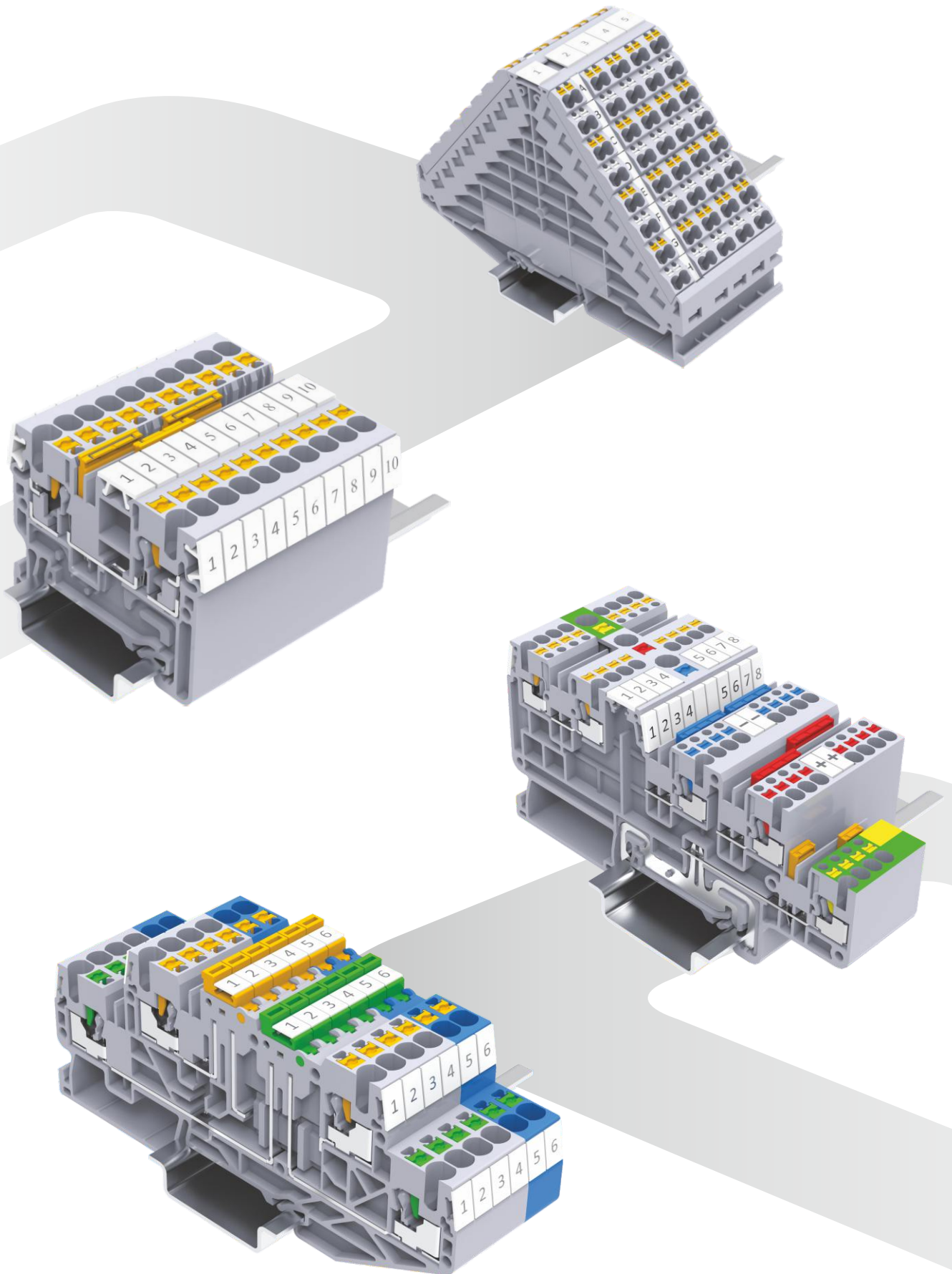







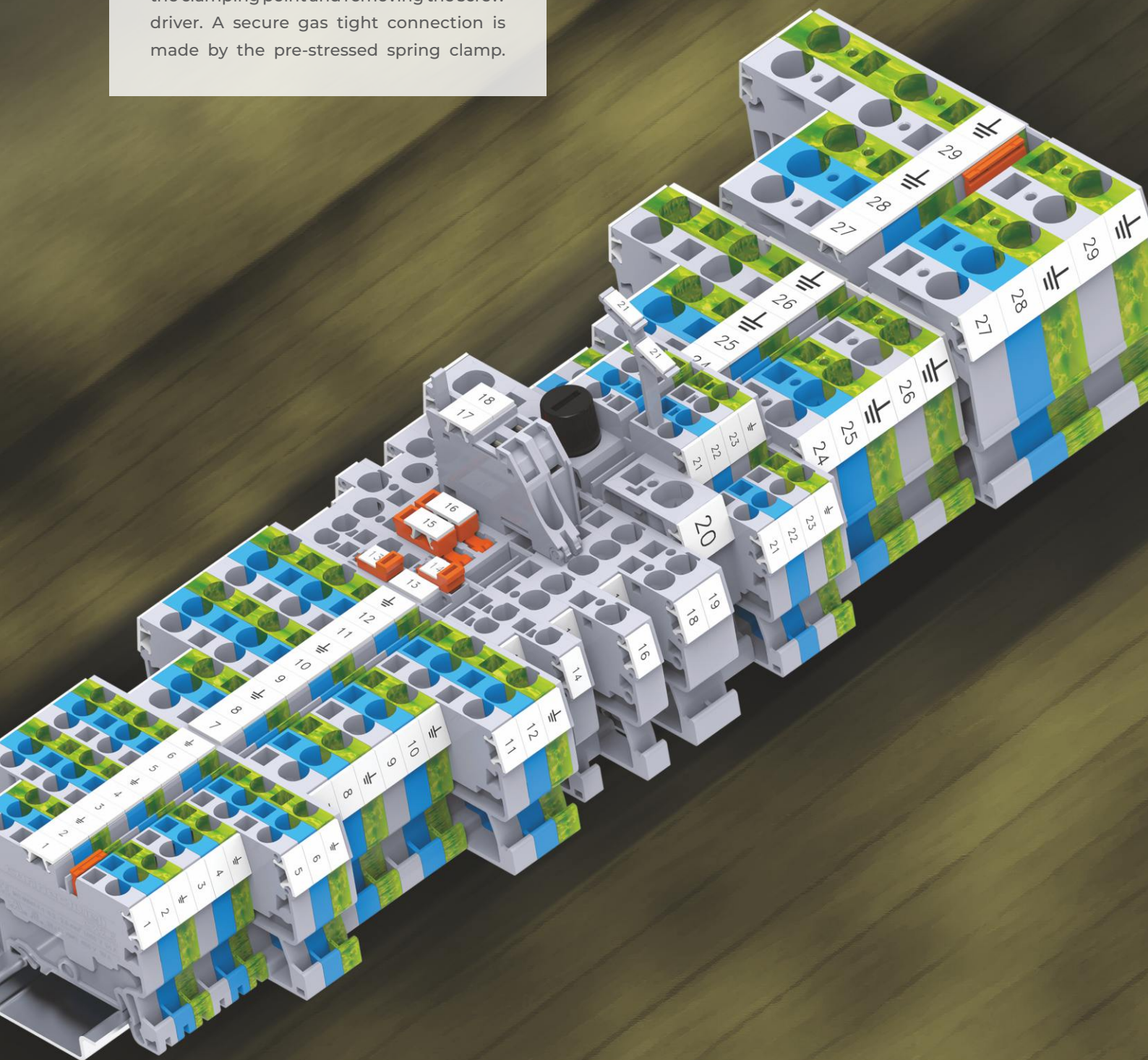









CX SERIES SPRING CLAMP

TERMINAL BLOCKS

The CX series Terminal Blocks have a highly reliable spring clamp connection system. The spring clamp is actuated using standard screw drivers and connection is completed by simply inserting the prepared wire in the clamping point and removing the screw driver. A secure gas tight connection is made by the pre-stressed spring clamp.



CX SERIES SPRING CLAMP TERMINAL BLOCKS

	Feed Through	51 - 53
	Multiple Connection	54 - 57
	Ground / Earth	58 - 63
	Multiple Level	65 - 68
	Fuse Terminal	69 - 70
	Disconnect & Test	71 - 72
	Micro	73 - 74
	Side Entry Feed Through	75 - 76
	Side Entry Ground / Earth	77 - 78
	Hybrid Distribution	79
	Angular Feed Through	81 - 84
	Angular Ground / Earth	85 - 88
	Panel Mount	89 - 93
	Component Carrier	94 - 95
	With Electronic Components	96 - 97
	Pluggable	98 - 104

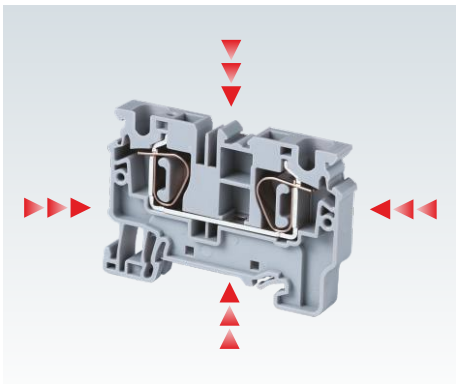

CX series Terminal Blocks have an extremely compact design. These Terminal Blocks can be used in smaller control cabinets and enclosures.

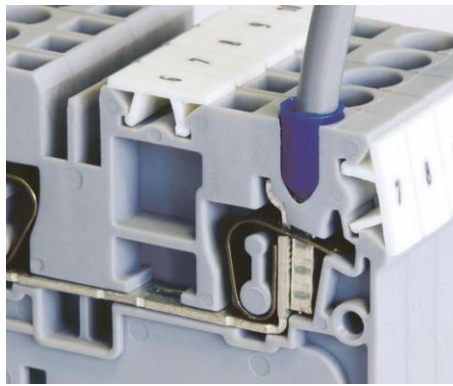

A unique design in the plastic housing of the Terminal Block facilitates ease of wire entry. Wires can be used with or without ferrules / lugs.

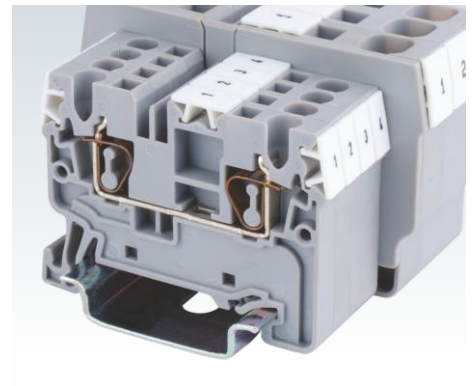

High quality stainless steel spring clamps provide a gas tight connection. A vibration proof, anti-loosening wire connection is achieved with this pre-stressed spring clamp system.

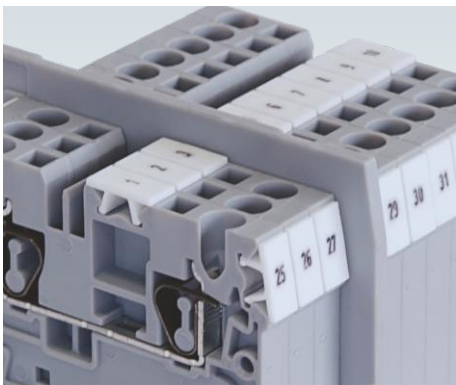

Partition Plates can be individually mounted on DIN rails between Terminal Blocks to provide electrical and visual separation.

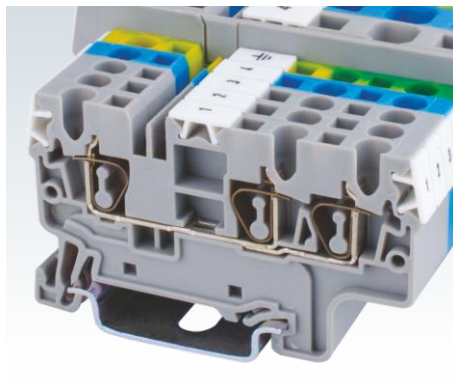

Multi connection Terminal Blocks are used for applications involving more than one same potential wires to be connected.

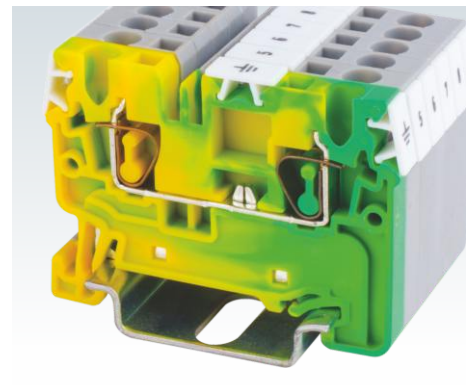

Ground Terminal Blocks have specially designed metal alloy feet which snap on to the DIN rail. They are green-yellow colour coded as per industry norms.

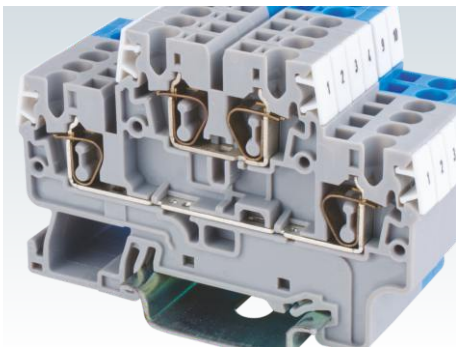

Double level Terminal Blocks enable high density wiring. Each level can be independently shorted to suit various applications.

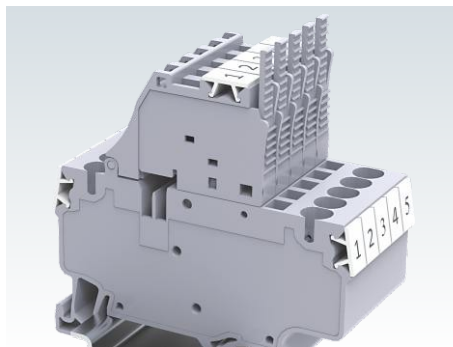

Fuse Terminal Blocks have an integral built-in end plate. They are available in various configurations including LED variants for indication fuse blow out.

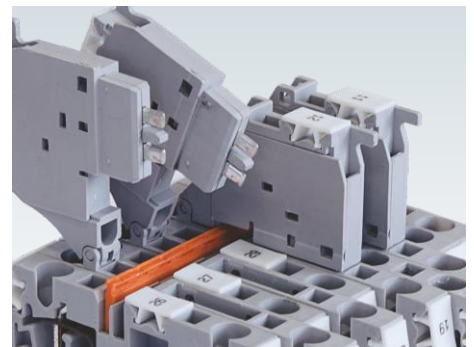

Feed Through Terminal Blocks can be simultaneously shorted in an alternating configuration with Fuse & Disconnecting Terminal Blocks using pluggable jumpers.

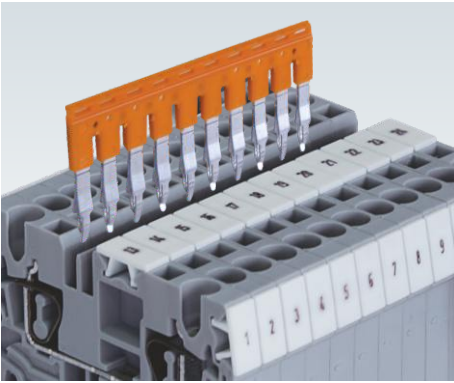

Pluggable jumpers can be inserted in the Terminal Blocks for cross connection. They are available in various pole configurations.



Specific Terminal Blocks in an assembly can be shorted by breaking intermediate contacts from the standard jumpers.



The possibility of using 2 independent rows for jumpers enables the creation of various circuit combinations. Jumpers can be marked with a felt tip pen on the recess provided on top, to clearly indicate shorted positions.



The jumper and marking tag position is aligned across different types of CX series Terminal Blocks. This facilitates shorting and marking adjacent terminals with different functionalities.

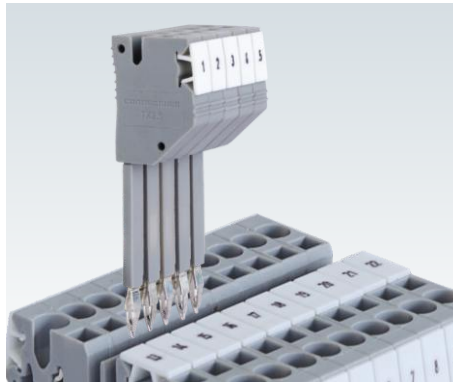

Specially designed Test Plugs are available for CX series Terminal Blocks for quick testing and measurement.

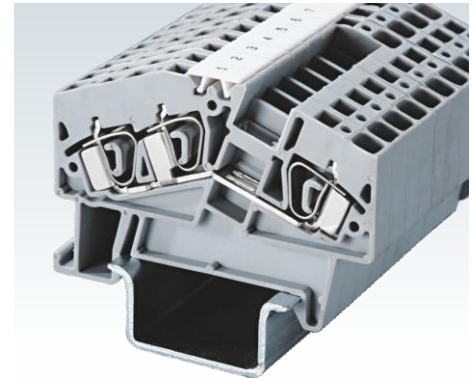

The AS series Terminal Blocks have an angled wire entry making it suitable for underfloor wiring systems. These Terminal Blocks are compact with the 2 wire, 3 wire & 4 wire terminals having the same profile.

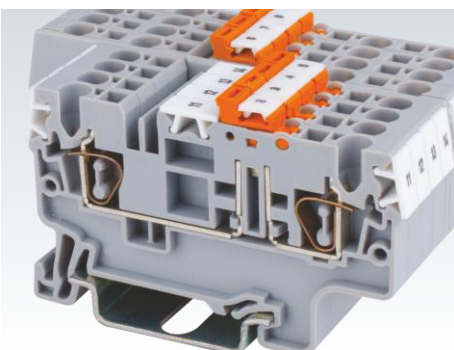

The spring clamp knife disconnect terminal system enables isolation of circuits. A standard test plug can be used with these Terminal Blocks.

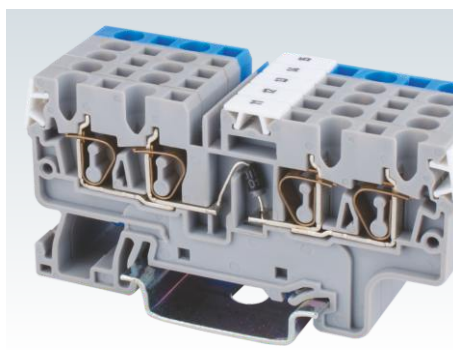

Spring clamp Terminal Blocks with electronic components are designed to meet various rectification and filtering application requirements.



Panel mounting Terminal Blocks can be easily mounted on the panel surface with the help of fixing screws. They can be interlocked to form multi-pole configurations.

FEED THROUGH TERMINAL BLOCKS

CX series Spring Clamp Terminal Blocks are the next generation, compact terminals. These series of Terminal Blocks have an improved 1000 V rating as per IEC guidelines. The new CX series terminals have a much wider range for wire terminations.





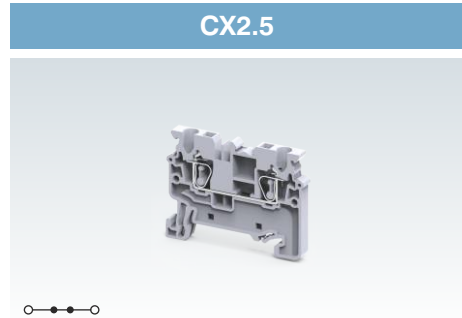

The wire is held directly against the copper current bar by pre stressed spring clamps.

Cross connection of these Terminal Blocks can be done using insulated pluggable jumpers available in various pole configurations.

The terminals with  & IECEx approval can be used in potentially explosive atmosphere. For detailed information refer page 289.

Width (Thickness) x Length	5 x 50 mm			
Height with DIN 35 x 7.5 / 35 x 15 mm Rail	38.2 mm / 45.7 mm			
Connection Possibility as per	IEC		UL - CSA	
With 1 Conductor per clamp	Stranded / Flexible	0.2 - 2.5 mm ²	24 - 12 AWG	
	Solid	0.2 - 4.0 mm ²	24 - 10 AWG	
	with Ferrule / Lug	0.2 - 2.5 mm ²	24 - 12 AWG	
With 2 same size Conductors per clamp	with TWIN Ferrule / Lug	0.5 mm ²	20 AWG	
Wire Stripping Length	10 mm			
Ratings As Per	IEC60947-1	UL-1059	CSA22.2-158	IEC60079-7
Voltage	1000 V	600 V	600 V	630 V
Current	24 A	20 A	20 A	21 A
Approval				
Insulation Material / Material Group	Polyamide 6,6 / 1			
Rated Impulse Voltage / Pollution Degree	8 KV / 3			



		Type / Cat. No.	Standard Pack	
Terminal Block	Grey	CX2.5	100	
	Blue	CX2.5BU	100	
	Red	CX2.5R	100	
	Yellow	CX2.5Y	100	
	Black	CX2.5BK	100	
	Green	CX2.5GN	100	
	Ground / Earth	CXG2.5 (Refer Pg. 58 for Details)	100	
End Plate		EPCX2.5	50	
Partition Plate		PPCX4	50	
Mounting Rail (Refer Pg. 263 for details)		CA701-1M / CA701-1M-S	50 m	
		CA701-15-1M / CA701-15-1M-S	25 m	
End Clamp (Refer Pg. 264 for details)		CA103 / CA104	50	
Warning Label		WLX2.5	100	
Marking Tags (Refer Pg. 268 for details)		CA509/K5WHT	100	
Marker Card (Refer Pg. 269 for details)		MC5	10	
Screw Driver		SCM0.5/3 Blade size: 0.5 x 3.0 mm	10	
Jumpers		Type / Cat. No.	I _{max}	Standard Pack
Pluggable Jumpers	2 pole	JX2.5/2	24 A	100
	3 pole	JX2.5/3	24 A	50
	4 pole	JX2.5/4	24 A	50
	5 pole	JX2.5/5	24 A	50
	6 pole	JX2.5/6	24 A	10
	7 pole	JX2.5/7	24 A	10
	8 pole	JX2.5/8	24 A	10
	10 pole	JX2.5/10	24 A	10
	16 pole			
	20 pole	JX2.5/20	24 A	10
Step Down Jumpers	6 - 2.5 mm ²	JXS6/2.5	24 A	50
	6 - 4 mm ²			
	10 - 6 mm ²			
	10 - 4 mm ²			
	16 - 2.5 mm ²	JXS16/2.5	24 A	50
		JXS16/2.5	24 A	50
Test Plug		TX2.5		20

CX4

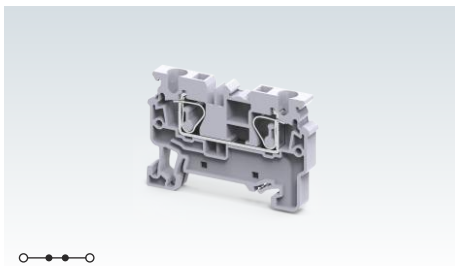

6 x 55 mm
38 mm / 45.8 mm

IEC	UL - CSA
0.2 - 4.0 mm ²	24 - 10 AWG
0.2 - 6.0 mm ²	
0.2 - 4.0 mm ²	24 - 10 AWG
0.5 - 1.0 mm ²	20 - 18 AWG

10 mm
IEC60947-7-1 UL-1059 CSA22.2-158 IEC60079-7

1000 V	600 V	600 V	630 V
32 A	30 A	30 A	28 A



Polyamide 6,6 / 1
8 KV / 3

Type / Cat. No.	Standard Pack
CX4	100
CX4BU	100
CX4R	100
CX4Y	100
CX4BK	100
CX4GN	100
CXG4 (Refer Pg. 59 for Details)	100
EPCX4	50
PPCX4	50
CA701-1M / CA701-1M-S	50 m
CA701-15-1M / CA701-15-1M-S	25 m
CA103 / CA104	50
WLX4	100
CA509/K6WHT	100
MC6	10
SCM0.6/3.5 Blade size: 0.6 x 3.5 mm	10

Type / Cat. No.	I _{max}	Standard Pack
JX4/2	32 A	100
JX4/3	32 A	50
JX4/4	32 A	50
JX4/5	32 A	50
JX4/6	32 A	50
JX4/8	32 A	10
JX4/10	32 A	10
JX4/16	32 A	10

JXS6/4	32 A	50
JXS10/4	32 A	50

CX6

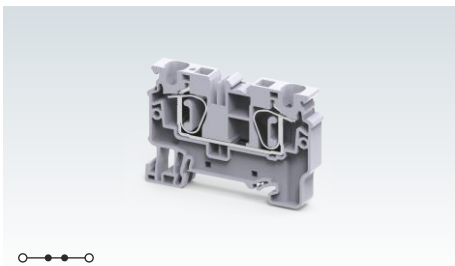

8 x 62.7 mm
43 mm / 50.5 mm

IEC	UL - CSA
0.2 - 6.0 mm ²	24 - 8 AWG
0.2 - 6.0 mm ²	
0.2 - 6.0 mm ²	24 - 8 AWG
0.5 - 1.5 mm ²	20 - 16 AWG

14 mm
IEC60947-7-1 UL-1059 CSA22.2-158 IEC60079-7

1000 V	600 V	600 V	630 V
41 A	50 A	50 A	36 A



Polyamide 6,6 / 1
8 KV / 3

Type / Cat. No.	Standard Pack
CX6	100
CX6BU	100
CX6R	100
CX6Y	100
CX6BK	100
CX6GN	100
CXG6 (Refer Pg. 59 for Details)	100
EPCX6	50
PPCX10	20
CA701-1M / CA701-1M-S	50 m
CA701-15-1M / CA701-15-1M-S	25 m
CA103 / CA104	50
WLX6	50
CA509/K8WHT	100
MC8	10
SCM0.8/4 Blade size: 0.8 x 4 mm	10

Type / Cat. No.	I _{max}	Standard Pack
JX6/2	41 A	100
JX6/3	41 A	50
JX6/4	41 A	50
JX6/5	41 A	50
JX6/10	41 A	10

JXS6/2.5	24 A	50
JXS6/4	32 A	50
JXS10/6	41 A	50

CX10

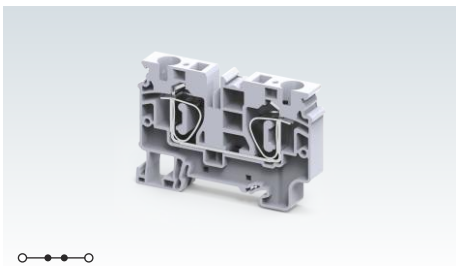

10 x 72.4 mm
49.3 mm / 56.8 mm

IEC	UL - CSA
0.2 - 10.0 mm ²	24 - 6 AWG
0.2 - 10.0 mm ²	
0.2 - 10.0 mm ²	24 - 6 AWG
0.5 - 2.5 mm ²	20 - 14 AWG

18 mm
IEC60947-7-1 UL-1059 CSA22.2-158 IEC60079-7

1000 V	600 V	600 V	630 V
57 A	65 A	65 A	51 A



Polyamide 6,6 / 1
8 KV / 3

Type / Cat. No.	Standard Pack
CX10	50
CX10BU	50
CX10R	50
CX10Y	50
CX10BK	50
CX10GN	50
CXG10 (Refer Pg. 60 for Details)	50
EPCX10	50
PPCX10	20
CA701-1M / CA701-1M-S	50 m
CA701-15-1M / CA701-15-1M-S	25 m
CA103 / CA104	50
WLX10	50
CA509/K10WHT	100
MC10	10
SCM0.8/4 Blade size: 0.8 x 4 mm	10

Type / Cat. No.	I _{max}	Standard Pack
JX10/2	57 A	20

JXS10/6	41 A	50
JXS10/4	32 A	50
JXS10/2.5	24 A	50

CSC16T

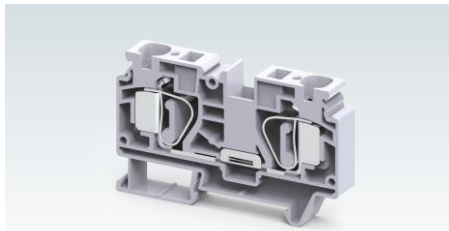

CX35

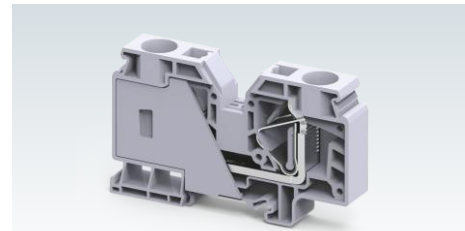

Width (Thickness) x Length	12 x 82 mm			
Height with DIN 35 x 7.5 / 35 x 15 mm Rail	51.2 mm / 58.7 mm			
Connection Possibility as per	IEC	UL - CSA		
With 1 Conductor per clamp	Stranded / Flexible	1.5 - 16.0 mm ²	16 - 4 AWG	
	Solid with Ferrule / Lug	1.5 - 16.0 mm ²	16 - 4 AWG	
With 2 same size Conductors per clamp	with TWIN Ferrule / Lug	1.5 - 4.0 mm ²	20 - 12 AWG	
Wire Stripping Length	20 mm			
Ratings As Per	IEC60947-7-1	UL-1059	CSA22.2-158	IEC60079-7
Voltage	800 V	600 V	600 V	630 V
Current	76 A	85 A	85 A	66 A
Approvals				
Insulation Material / Material Group	Polyamide 6,6 / 1			
Rated Impulse Voltage / Pollution Degree	8 KV / 3			

Width (Thickness) x Length	16 x 100 mm		
Height with DIN 35 x 7.5 / 35 x 15 mm Rail	60.3 mm / 67.8 mm		
Connection Possibility as per	IEC	UL - CSA	
With 1 Conductor per clamp	Stranded / Flexible	2.5 - 35.0 mm ²	14 - 2 AWG
	Solid with Ferrule / Lug	2.5 - 35.0 mm ²	14 - 2 AWG
With 2 same size Conductors per clamp	with TWIN Ferrule / Lug	2.5 - 10.0 mm ²	14 - 8 AWG
Wire Stripping Length	23 mm		
Ratings As Per	IEC60947-7-1	UL-1059	
Voltage	800 V	600 V	
Current	125 A	115 A	
Approvals			
Insulation Material / Material Group	Polyamide 6,6 / 1		
Rated Impulse Voltage / Pollution Degree	8 KV / 3		

Terminal Block	Grey	CSC16T	50
	Blue	CSC16TBU	50
	Red	CSC16TR	50
	Yellow	CSC16TY	50
	Black	CSC16TBK	50
	Green	CSC16TGN	50
	Ground / Earth	CSCG16T (Refer Pg. 60 for Details)	50
End Plate		EPCSC16T	50
Mounting Rail (Refer Pg. 263 for details)		CA701-1M / CA701-1M-S	50 m
		CA701-15-1M / CA701-15-1M-S	25 m
End Clamp (Refer Pg. 264 for details)		CA103 / CA104	50
Warning Label		SWL16	100
Marking Tags (Refer Pg. 268 for details)		CA509/K12WHT	100
Marker Card (Refer Pg. 269 for details)		MC12	10
Screw Driver		SCM1.0/5.5 Blade size: 1.0 x 5.5 mm	10

Terminal Block	Grey	CX35	50
	Blue	CX35BU	50
End Plate			
Mounting Rail (Refer Pg. 263 for details)		CA701-1M / CA701-1M-S	50 m
		CA701-15-1M / CA701-15-1M-S	25 m
End Clamp (Refer Pg. 264 for details)		CA103 / CA104	50
Warning Label			
Marking Tags (Refer Pg. 268 for details)		CA509/K16WHT	100
Marker Card (Refer Pg. 269 for details)		MC16	10
Screw Driver		SCM1.0/5.5 Blade size: 1.0 x 5.5 mm	10

Terminal Block	Grey	CX35	50
	Blue	CX35BU	50
End Plate			
Mounting Rail (Refer Pg. 263 for details)		CA701-1M / CA701-1M-S	50 m
		CA701-15-1M / CA701-15-1M-S	25 m
End Clamp (Refer Pg. 264 for details)		CA103 / CA104	50
Warning Label			
Marking Tags (Refer Pg. 268 for details)		CA509/K16WHT	100
Marker Card (Refer Pg. 269 for details)		MC16	10
Screw Driver		SCM1.0/5.5 Blade size: 1.0 x 5.5 mm	10

Jumpers			
		2 Pole	CA801/5
Step Down Jumpers		16 - 2.5 mm ²	JXS16/2.5

Jumpers			
		76 A	100
		24 A	100

Jumpers			
		90 A	100

MULTIPLE CONNECTION TERMINAL BLOCKS

CX series multi connect 3 wire & 4 wire spring clamp Terminal Blocks are used to eliminate reliability problems encountered when there is a need to connect multiple wires in a single Terminal Block.

CX2.5/4P is a double potential Terminal Block. It allows two different system voltages to be run through the same terminal block. One side of the Terminal Block can be shorted with standard insulated push-in jumpers.





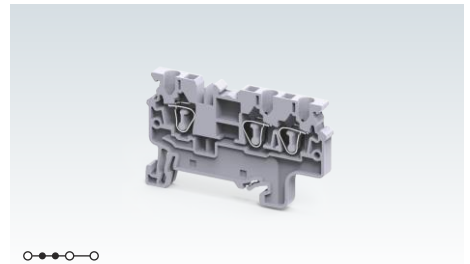

The terminals with  & IECEx approval can be used in potentially explosive atmosphere. For detailed information refer page 289.

CX2.5/3



Width (Thickness) x Length		5 x 60.5 mm
Height with DIN 35 x 7.5 / 35 x 15 mm Rail		38.2 mm / 45.7 mm
Connection Possibility as per		
With 1 Conductor per clamp	Stranded / Flexible	0.2 - 2.5 mm ²
	Solid with Ferrule / Lug	0.2 - 4.0 mm ²
With 2 same size Conductors per clamp	with TWIN Ferrule / Lug	0.2 - 2.5 mm ²
		0.5 mm ²
Wire Stripping Length		10 mm
Ratings As Per		IEC60947-7-1 UL-1059 CSA22.2-158 IEC60079-7
Voltage		1000 V 600 V 600 V 630 V
Current		24 A 20 A 20 A 21 A
Approval		
Insulation Material / Material Group		Polyamide 6,6 / 1
Rated Impulse Voltage / Pollution Degree		8 KV / 3

IEC		UL - CSA	
0.2 - 2.5 mm ²		24 - 12 AWG	
0.2 - 4.0 mm ²		24 - 10 AWG	
0.2 - 2.5 mm ²		24 - 12 AWG	
0.5 mm ²		20 AWG	
10 mm			
IEC60947-7-1		UL-1059	CSA22.2-158 IEC60079-7
1000 V	600 V	600 V	630 V
24 A	20 A	20 A	21 A
			
Polyamide 6,6 / 1			
8 KV / 3			

Terminal Block	Grey Blue Red Yellow Black Green Ground / Earth
End Plate	
Partition Plate	
Mounting Rail (Refer Pg. 263 for details)	
End Clamp (Refer Pg. 264 for details)	
Warning Label	
Marking Tags (Refer Pg. 268 for details)	
Marker Card (Refer Pg. 269 for details)	
Screw Driver	

Type / Cat. No.	Standard Pack
CX2.5/3	100
CX2.5/3BU	100
CX2.5/3R	100
CX2.5/3Y	100
CX2.5/3BK	100
CX2.5/3GN	100
CXG2.5/3 (Refer Pg. 61 for Details)	100
EPCX2.5/3	50
PPCX4/3	50
CA701-1M / CA701-1M-S	50 m
CA701-15-1M / CA701-15-1M-S	25 m
CA103 / CA104	50
WLX2.5	100
CA509/K5WHT	100
MC5	10
SCM0.5/3 Blade size: 0.5 x 3.0 mm	10

Jumpers	
Pluggable Jumpers	
	2 pole
	3 pole
	4 pole
	5 pole
	6 pole
	7 pole
	8 pole
	10 pole
	16 pole
20 pole	
Step Down Jumpers	6 - 2.5 mm ²
	10 - 2.5 mm ²
	16 - 2.5 mm ²
Test Plug	

Type / Cat. No.	I _{max}	Standard Pack
JX2.5/2	24 A	100
JX2.5/3	24 A	50
JX2.5/4	24 A	50
JX2.5/5	24 A	50
JX2.5/6	24 A	10
JX2.5/7	24 A	10
JX2.5/8	24 A	10
JX2.5/10	24 A	10
JX2.5/20	24 A	10
JXS6/2.5	24 A	50
JXS10/2.5	24 A	50
JXS16/2.5	24 A	50
TX2.5		20

CX2.5/4

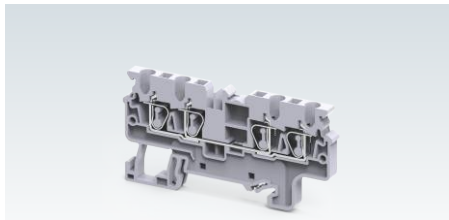

CX2.5/4P

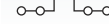
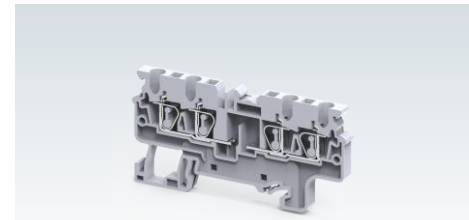

Width (Thickness) x Length	5 x 73 mm	
Height with DIN 35 x 7.5 / 35 x 15 mm Rail	38.2 mm / 45.7 mm	
Connection Possibility as per	IEC	UL - CSA
With 1 Conductor per clamp	Stranded / Flexible	0.2 - 2.5 mm ²
	Solid	0.2 - 4.0 mm ²
	with Ferrule / Lug	0.2 - 2.5 mm ²
With 2 same size Conductors per clamp	with TWIN Ferrule / Lug	0.5 mm ²
Wire Stripping Length	10 mm	
Ratings As Per	IEC60947-7-1	UL-1059 CSA22.2-158 IEC60079-7
Voltage	1000 V	600 V
Current	24 A	20 A
Approval		
Insulation Material / Material Group	Polyamide 6,6 / 1	
Rated Impulse Voltage / Pollution Degree	8 KV / 3	

Width (Thickness) x Length	5 x 73 mm	
Height with DIN 35 x 7.5 / 35 x 15 mm Rail	38.2 mm / 45.7 mm	
Connection Possibility as per	IEC	UL - CSA
With 1 Conductor per clamp	Stranded / Flexible	0.2 - 2.5 mm ²
	Solid	0.2 - 4.0 mm ²
	with Ferrule / Lug	0.2 - 2.5 mm ²
With 2 same size Conductors per clamp	with TWIN Ferrule / Lug	0.5 mm ²
Wire Stripping Length	10 mm	
Ratings As Per	IEC60947-7-1	UL-1059 CSA22.2-158 IEC60079-7
Voltage	1000 V	600 V
Current	24 A	20 A
Approval		
Insulation Material / Material Group	Polyamide 6,6 / 1	
Rated Impulse Voltage / Pollution Degree	8 KV / 3	

Width (Thickness) x Length	5 x 73 mm	
Height with DIN 35 x 7.5 / 35 x 15 mm Rail	38.2 mm / 45.7 mm	
Connection Possibility as per	IEC	UL - CSA
With 1 Conductor per clamp	Stranded / Flexible	0.2 - 2.5 mm ²
	Solid	0.2 - 4.0 mm ²
	with Ferrule / Lug	0.2 - 2.5 mm ²
With 2 same size Conductors per clamp	with TWIN Ferrule / Lug	0.5 mm ²
Wire Stripping Length	10 mm	
Ratings As Per	IEC60947-7-1	UL-1059 CSA22.2-158
Voltage	1000 V	600 V
Current	24 A	20 A
Approval		
Insulation Material / Material Group	Polyamide 6,6 / 1	
Rated Impulse Voltage / Pollution Degree	8 KV / 3	

Terminal Block	Grey	CX2.5/4	100
	Blue	CX2.5/4BU	100
	Red	CX2.5/4R	100
	Yellow	CX2.5/4Y	100
	Black	CX2.5/4BK	100
	Green	CX2.5/4GN	100
	Ground / Earth	CXG2.5/4 (Refer Pg. 61 for Details)	100
End Plate		EPCX2.5/4	50
Partition Plate		PPCX4/4	50
Mounting Rail (Refer Pg. 263 for details)		CA701-1M / CA701-1M-S	50 m
		CA701-15-1M / CA701-15-1M-S	25 m
End Clamp (Refer Pg. 264 for details)		CA103 / CA104	50
Warning Label		WLX2.5	100
Marking Tags (Refer Pg. 268 for details)		CA509/K5WHT	100
Marker Card (Refer Pg. 269 for details)		MC5	10
Screw Driver		SCM0.5/3 Blade size: 0.5 x 3.0 mm	10

Terminal Block	Grey	CX2.5/4	100
	Blue	CX2.5/4BU	100
	Red	CX2.5/4R	100
	Yellow	CX2.5/4Y	100
	Black	CX2.5/4BK	100
	Green	CX2.5/4GN	100
	Ground / Earth	CXG2.5/4 (Refer Pg. 61 for Details)	100
End Plate		EPCX2.5/4	50
Partition Plate		PPCX4/4	50
Mounting Rail (Refer Pg. 263 for details)		CA701-1M / CA701-1M-S	50 m
		CA701-15-1M / CA701-15-1M-S	25 m
End Clamp (Refer Pg. 264 for details)		CA103 / CA104	50
Warning Label		WLX2.5	100
Marking Tags (Refer Pg. 268 for details)		CA509/K5WHT	100
Marker Card (Refer Pg. 269 for details)		MC5	10
Screw Driver		SCM0.5/3 Blade size: 0.5 x 3.0 mm	10

Terminal Block	Grey	CX2.5/4P	100
	Blue	CX2.5/4PBU	100
	Red	CX2.5/4PR	100
	Yellow	CX2.5/4PY	100
	Black	CX2.5/4PBK	100
	Green	CX2.5/4PGN	100
	Ground / Earth	CXG2.5/4P (Refer Pg. 61 for Details)	100
End Plate		EPCX2.5/4P	50
Partition Plate		PPCX4/4P	50
Mounting Rail (Refer Pg. 263 for details)		CA701-1M / CA701-1M-S	50 m
		CA701-15-1M / CA701-15-1M-S	25 m
End Clamp (Refer Pg. 264 for details)		CA103 / CA104	50
Warning Label		WLX2.5P	100
Marking Tags (Refer Pg. 268 for details)		CA509/K5WHT	100
Marker Card (Refer Pg. 269 for details)		MC5	10
Screw Driver		SCM0.5/3 Blade size: 0.5 x 3.0 mm	10

Pluggable Jumpers		2 pole	JX2.5/2	24 A	100
		3 pole	JX2.5/3	24 A	50
		4 pole	JX2.5/4	24 A	50
		5 pole	JX2.5/5	24 A	50
		6 pole	JX2.5/6	24 A	10
		7 pole	JX2.5/7	24 A	10
		8 pole	JX2.5/8	24 A	10
		10 pole	JX2.5/10	24 A	10
		16 pole	JX2.5/20	24 A	10
		20 pole	JX2.5/20	24 A	10
Step Down Jumpers		6 - 2.5 mm ²	JXS6/2.5	24 A	50
		6 - 4 mm ²			
		10 - 6 mm ²			
		10 - 4 mm ²			
Test Plug		10 - 2.5 mm ²	JXS10/2.5	24 A	50
		16 - 2.5 mm ²	JXS16/2.5	24 A	50
Test Plug		TX2.5		20	

Pluggable Jumpers		2 pole	JX2.5/2	24 A	100
		3 pole	JX2.5/3	24 A	50
		4 pole	JX2.5/4	24 A	50
		5 pole	JX2.5/5	24 A	50
		6 pole	JX2.5/6	24 A	10
		7 pole	JX2.5/7	24 A	10
		8 pole	JX2.5/8	24 A	10
		10 pole	JX2.5/10	24 A	10
		16 pole	JX2.5/20	24 A	10
		20 pole	JX2.5/20	24 A	10
Step Down Jumpers		6 - 2.5 mm ²	JXS6/2.5	24 A	50
		6 - 4 mm ²			
		10 - 6 mm ²			
		10 - 4 mm ²			
Test Plug		10 - 2.5 mm ²	JXS10/2.5	24 A	50
		16 - 2.5 mm ²	JXS16/2.5	24 A	50
Test Plug		TX2.5		20	

Pluggable Jumpers		2 pole	JX2.5/2	24 A	100
		3 pole	JX2.5/3	24 A	50
		4 pole	JX2.5/4	24 A	50
		5 pole	JX2.5/5	24 A	50
		6 pole	JX2.5/6	24 A	10
		7 pole	JX2.5/7	24 A	10
		8 pole	JX2.5/8	24 A	10
		10 pole	JX2.5/10	24 A	10
		16 pole	JX2.5/20	24 A	10
		20 pole	JX2.5/20	24 A	10
Step Down Jumpers		6 - 2.5 mm ²	JXS6/2.5	24 A	50
		6 - 4 mm ²			
		10 - 6 mm ²			
		10 - 4 mm ²			
Test Plug		10 - 2.5 mm ²	JXS10/2.5	24 A	50
		16 - 2.5 mm ²	JXS16/2.5	24 A	50
Test Plug		TX2.5		20	

CX4/3

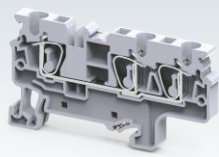

6 x 70.8 mm
38 mm / 45.8 mm

IEC	UL - CSA
0.2 - 4.0 mm ²	24 - 10 AWG
0.2 - 6.0 mm ²	24 - 8 AWG
0.2 - 4.0 mm ²	24 - 10 AWG
0.5 - 1.0 mm ²	20 - 18 AWG

10 mm

IEC60947-7-1 UL-1059 CSA22.2-158 IEC60079-7

1000 V	600 V	600 V	630 V
32 A	30 A	30 A	28 A



Polyamide 6,6 / 1

8 KV / 3

CX4/4

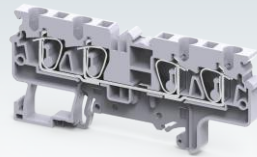

6 x 86.2 mm
38 mm / 45.8 mm

IEC	UL - CSA
0.2 - 4.0 mm ²	24 - 10 AWG
0.2 - 6.0 mm ²	24 - 8 AWG
0.2 - 4.0 mm ²	24 - 10 AWG
0.5 - 1.0 mm ²	20 - 18 AWG

10 mm

IEC60947-7-1 UL-1059 CSA22.2-158 IEC60079-7

1000 V	600 V	600 V	630 V
32 A	30 A	30 A	28 A



Polyamide 6,6 / 1

8 KV / 3

CX6/3

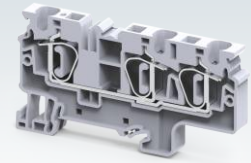

8 x 82.8 mm
43 mm / 50.5 mm

IEC	UL - CSA
0.2 - 6.0 mm ²	24 - 8 AWG
0.2 - 6.0 mm ²	24 - 8 AWG
0.5 - 1.5 mm ²	20 - 16 AWG

14 mm

IEC60947-7-1 UL-1059 CSA22.2-158 IEC60079-7

1000 V	600 V	600 V	630 V
41 A	50 A	50 A	36 A



Polyamide 6,6 / 1

8 KV / 3

Type / Cat. No.	Standard Pack
CX4/3	50
CX4/3BU	50
CX4/3R	50
CX4/3Y	50
CX4/3BK	50
CX4/3GN	50
CXG4/3 (Refer Pg. 62 for Details)	50
EPCX4/3	50
PPCX4/3	50
CA701-1M / CA701-1M-S	50 m
CA701-15-1M / CA701-15-1M-S	25 m
CA103 / CA104	50
WLX4	50
CA509/K5WHT	100
MC5	10
SCM0.6/3.5 Blade size: 0.6 x 3.5 mm	10

Type / Cat. No.	I _{max}	Standard Pack
JX4/2	32 A	100
JX4/3	32 A	50
JX4/4	32 A	50
JX4/8	32 A	10
JX4/10	32 A	10
JX4/16	32 A	10

JXS6/4	32 A	50
JXS10/4	32 A	50

Type / Cat. No.	Standard Pack
CX4/4	50
CX4/4BU	50
CX4/4R	50
CX4/4Y	50
CX4/4BK	50
CX4/4GN	50
CXG4/4 (Refer Pg. 62 for Details)	50
EPCX4/4	50
PPCX4/4	50
CA701-1M / CA701-1M-S	50 m
CA701-15-1M / CA701-15-1M-S	25 m
CA103 / CA104	50
WLX4	50
CA509/K6WHT	100
MC6	10
SCM0.6/3.5 Blade size: 0.6 x 3.5 mm	10

Type / Cat. No.	I _{max}	Standard Pack
JX4/2	32 A	100
JX4/3	32 A	50
JX4/4	32 A	50
JX4/8	32 A	10
JX4/10	32 A	10
JX4/16	32 A	10

JXS6/4	32 A	50
JXS10/4	32 A	50

Type / Cat. No.	Standard Pack
CX6/3	50
CX6/3BU	50
CX6/3R	50
CX6/3Y	50
CX6/3BK	50
CX6/3GN	50
CXG6/3 (Refer Pg. 62 for Details)	50
EPCX6/3	50
CA701-1M / CA701-1M-S	50 m
CA701-15-1M / CA701-15-1M-S	25 m
CA103 / CA104	50
WLX6	50
CA509/K8WHT	100
MC8	10
SCM0.8/4 Blade size: 0.8 x 4 mm	10

Type / Cat. No.	I _{max}	Standard Pack
JX6/2	41 A	100
JX6/3	41 A	50
JX6/4	41 A	50
JX6/5	41 A	50

JX6/10	41 A	10
--------	------	----

JXS6/2.5	34 A	50
JXS6/4	32 A	50
JXS10/6	41 A	50

CX10/3

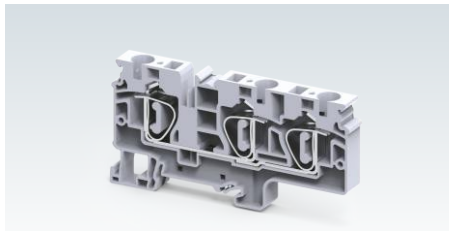

CSC16/3T

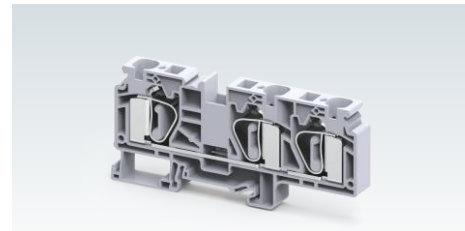

Width (Thickness) x Length	10 x 97.6 mm
Height with DIN 35 x 7.5 / 35 x 15 mm Rail	49.3 mm / 56.6 mm
Connection Possibility as per	IEC
With 1 Conductor per clamp	Stranded / Flexible Solid
With 2 same size Conductors per clamp	with TWIN Ferrule / Lug
Wire Stripping Length	18 mm
Ratings As Per	IEC60947-7-1 UL-1059 IEC60079-7
Voltage	1000 V 600 V 630 V
Current	57 A 65 A 51 A
Approval	IEC CE UL US Ex IECEx AEx CCC T
Insulation Material / Material Group	Polyamide 6,6 / 1
Rated Impulse Voltage / Pollution Degree	8 KV / 3

Width (Thickness) x Length	12 x 111.9 mm
Height with DIN 35 x 7.5 / 35 x 15 mm Rail	51.2 mm / 58.7 mm
Connection Possibility as per	IEC
With 1 Conductor per clamp	Stranded / Flexible Solid
With 2 same size Conductors per clamp	with TWIN Ferrule / Lug
Wire Stripping Length	20 mm
Ratings As Per	IEC60947-7-1 UL-1059 CSA22.2-158
Voltage	800 V 600 V 600 V
Current	76 A 85 A 85 A
Approval	IEC CE UL US
Insulation Material / Material Group	Polyamide 6,6 / 1
Rated Impulse Voltage / Pollution Degree	8 KV / 3

Terminal Block	Grey Blue Red Yellow Black Green Ground / Earth	CX10/3 CX10/3BU CX10/3R CX10/3Y CX10/3BK CX10/3GN CXG10/3 (Refer Pg. 63 for Details)	50 50 50 50 50 50 50
End Plate		EPCX10/3	20
Mounting Rail (Refer Pg. 263 for details)		CA701-1M / CA701-1M-S CA701-15-1M / CA701-15-1M-S	50 m 25 m
End Clamp (Refer Pg. 264 for details)		CA103 / CA104	50
Warning Label		WLX10	50
Marking Tags (Refer Pg. 268 for details)		CA509/K10WHT	100
Marker Card (Refer Pg. 269 for details)		MC10	10
Screw Driver		SCM0.8/4 Blade size: 0.8 x 4 mm	10

Terminal Block	Grey Blue Red Yellow Black Green Ground / Earth	CSC16/3T CSC16/3TBU CSCG16/3T (Refer Pg. 63 for Details)	50 50 50 50 50 50 50
End Plate		EPCSC16/3T	50
Mounting Rail (Refer Pg. 263 for details)		CA701-1M / CA701-1M-S CA701-15-1M / CA701-15-1M-S	50 m 25 m
End Clamp (Refer Pg. 264 for details)		CA103 / CA104	50
Warning Label		SWL16	100
Marking Tags (Refer Pg. 268 for details)		CA509/K12WHT	100
Marker Card (Refer Pg. 269 for details)		MC12	10
Screw Driver		SCM1/5.5 Blade size: 1.0 x 5.5 mm	10

Jumpers	2 pole	JX10/2	57 A	20
Step Down Jumpers	10 - 2.5 mm ²	JXS10/2.5	24 A	50
	10 - 4 mm ²	JXS10/4	32 A	50
	10 - 6 mm ²	JXS10/6	41 A	50
	16 - 2.5 mm ²			

Jumpers	2 pole	JX10/2	57 A	20
Step Down Jumpers	10 - 2.5 mm ²	JXS10/2.5	24 A	50
	10 - 4 mm ²	JXS10/4	32 A	50
	10 - 6 mm ²	JXS10/6	41 A	50
	16 - 2.5 mm ²			

Jumpers	2 pole	CA801/5 (For CSC16/3T)	76 A	100
Step Down Jumpers	10 - 2.5 mm ²			
	10 - 4 mm ²			
	10 - 6 mm ²			
	16 - 2.5 mm ²	JXS16/2.5	76 A	100







GROUND / EARTH TERMINAL BLOCKS

CXG series are compact spring clamp earthing Terminal Blocks with specially designed alloy feet which help in achieving very low contact resistance and vibration proof grounding with the DIN rails. They are Green-Yellow colour coded as per industry standards.

Cross connection of these Terminal Blocks can be done using pluggable jumpers.

Multi connect 3 wire & 4 wire terminals eliminate reliability problems encountered when there is a need to connect multiple wires in a single Terminal Block.

The terminals with  & IECEx approval can be used in potentially explosive atmosphere. For detailed information refer page 289.

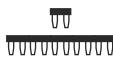
Width (Thickness) x Length		5 x 50 mm		
Height with DIN 35 x 7.5 / 35 x 15 mm Rail		38.2 mm / 45.7 mm		
Connection Possibility as per		IEC	UL - CSA	
With 1 Conductor per clamp	Stranded / Flexible	0.2 - 2.5 mm ²	24 - 12 AWG	
	Solid	0.2 - 4.0 mm ²	24 - 10 AWG	
	with Ferrule / Lug	0.2 - 2.5 mm ²	24 - 12 AWG	
With 2 same size Conductors per clamp	with TWIN Ferrule / Lug	0.5 mm ²	20 AWG	
Wire Stripping Length		10 mm		
Approval				
Insulation Material / Material Group		Polyamide 6,6 / 1		
Rated Impulse Voltage / Pollution Degree		8 KV / 3		
		Type / Cat. No.	Standard Pack	
Terminal Block		CXG2.5	100	
End Plate 		EPCX2.5	50	
Partition Plate 		PPCX4	50	
Mounting Rail (Refer Pg. 263 for details) 		CA701-1M / CA701-1M-S	50 m	
End Clamp (Refer Pg. 264 for details) 		CA701-15-1M / CA701-15-1M-S	25 m	
Warning Label		CA103 / CA104	50	
Warning Label		WLX2.5	100	
Marking Tags (Refer Pg. 268 for details) 		CA509/K5WHT	100	
Marker Card (Refer Pg. 269 for details)		MC5	10	
Screw Driver 		SCM0.5/3	Blade size: 0.5 x 3.0 mm 10	
Jumpers		Type / Cat. No.	I _{max}	Standard Pack
Pluggable Jumpers 	2 pole	JX2.5/2	24 A	100
	3 pole	JX2.5/3	24 A	50
	4 pole	JX2.5/4	24 A	50
	5 pole	JX2.5/5	24 A	50
	6 pole	JX2.5/6	24 A	10
	7 pole	JX2.5/7	24 A	10
	8 pole	JX2.5/8	24 A	10
	10 pole	JX2.5/10	24 A	10
	16 pole			
	20 pole	JX2.5/20	24 A	10
Step Down Jumpers	6 - 2.5 mm ²	JXS6/2.5	24 A	50
	10 - 2.5 mm ²	JXS10/2.5	24 A	50
	16 - 2.5 mm ²	JXS16/2.5	24 A	50
Test Plug		TX2.5		20

CXG2.5

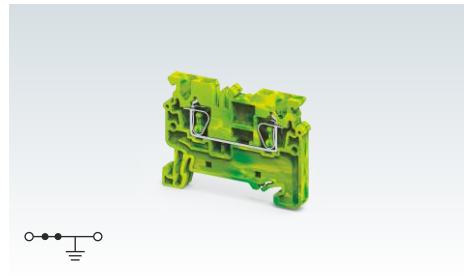

CXG4

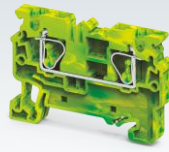

CXG6

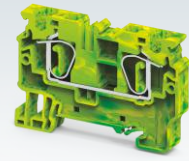

Width (Thickness) x Length	6 x 54.8 mm	
Height with DIN 35 x 7.5 / 35 x 15 mm Rail	38 mm / 45.5 mm	
Connection Possibility as per	IEC	UL - CSA
With 1 Conductor per clamp	Stranded / Flexible	0.2 - 4.0 mm ²
	Solid	0.2 - 6.0 mm ²
With 2 same size Conductors per clamp	with Ferrule / Lug	0.2 - 4.0 mm ²
	with TWIN Ferrule / Lug	0.5 - 1.0 mm ²
Wire Stripping Length	10 mm	
Approval		
Insulation Material / Material Group	Polyamide 6,6 / 1	
Rated Impulse Voltage / Pollution Degree	8 KV / 3	

Width (Thickness) x Length	6 x 54.8 mm	
Height with DIN 35 x 7.5 / 35 x 15 mm Rail	38 mm / 45.5 mm	
Connection Possibility as per	IEC	UL - CSA
With 1 Conductor per clamp	Stranded / Flexible	0.2 - 4.0 mm ²
	Solid	0.2 - 6.0 mm ²
With 2 same size Conductors per clamp	with Ferrule / Lug	0.2 - 4.0 mm ²
	with TWIN Ferrule / Lug	0.5 - 1.0 mm ²
Wire Stripping Length	10 mm	
Approval		
Insulation Material / Material Group	Polyamide 6,6 / 1	
Rated Impulse Voltage / Pollution Degree	8 KV / 3	

Width (Thickness) x Length	8 x 62.1 mm	
Height with DIN 35 x 7.5 / 35 x 15 mm Rail	42.2 mm / 50.5 mm	
Connection Possibility as per	IEC	UL - CSA
With 1 Conductor per clamp	Stranded / Flexible	0.2 - 6.0 mm ²
	Solid	0.2 - 6.0 mm ²
With 2 same size Conductors per clamp	with Ferrule / Lug	0.2 - 6.0 mm ²
	with TWIN Ferrule / Lug	0.5 - 1.5 mm ²
Wire Stripping Length	14 mm	
Approval		
Insulation Material / Material Group	Polyamide 6,6 / 1	
Rated Impulse Voltage / Pollution Degree	8 KV / 3	

	Type / Cat. No.	Standard Pack
Terminal Block	CXG4	100
End Plate	EPCX4	50
Partition Plate	PPCX4	50
Mounting Rail (Refer Pg. 263 for details)	CA701-1M / CA701-1M-S	50 m
	CA701-15-1M / CA701-15-1M-S	25 m
End Clamp (Refer Pg. 264 for details)	CA103 / CA104	50
Warning Label	WLX4	100
Marking Tags (Refer Pg. 268 for details)	CA509/K6WHT	100
Marker Card (Refer Pg. 269 for details)	MC6	10
Screw Driver	SCM0.6/3.5 Blade size: 0.6 x 3.5 mm	10

	Type / Cat. No.	Standard Pack
Terminal Block	CXG6	100
End Plate	EPCX6	50
Partition Plate	PPCX10	20
Mounting Rail (Refer Pg. 263 for details)	CA701-1M / CA701-1M-S	50 m
	CA701-15-1M / CA701-15-1M-S	25 m
End Clamp (Refer Pg. 264 for details)	CA103 / CA104	50
Warning Label	WLX6	50
Marking Tags (Refer Pg. 268 for details)	CA509/K8WHT	100
Marker Card (Refer Pg. 269 for details)	MC8	10
Screw Driver	SCM0.8/4 Blade size: 0.8 x 4 mm	10

	Type / Cat. No.	Standard Pack
Terminal Block	CXG6	100
End Plate	EPCX6	50
Partition Plate	PPCX10	20
Mounting Rail (Refer Pg. 263 for details)	CA701-1M / CA701-1M-S	50 m
	CA701-15-1M / CA701-15-1M-S	25 m
End Clamp (Refer Pg. 264 for details)	CA103 / CA104	50
Warning Label	WLX6	50
Marking Tags (Refer Pg. 268 for details)	CA509/K8WHT	100
Marker Card (Refer Pg. 269 for details)	MC8	10
Screw Driver	SCM0.8/4 Blade size: 0.8 x 4 mm	10

Jumpers	Type / Cat. No.	Imax	Standard Pack	
Pluggable Jumpers	2 pole	JX4/2	32 A	100
	3 pole	JX4/3	32 A	50
	4 pole	JX4/4	32 A	50
	5 pole	JX4/5	32 A	50
	6 pole	JX4/6	32 A	50
	8 pole	JX4/8	32 A	10
	10 pole	JX4/10	32 A	10
	16 pole	JX4/16	32 A	10
Step Down Jumpers	6 - 2.5 mm ²	JXS6/4	32 A	50
	6 - 4 mm ²			
	10 - 6 mm ²	JXS10/4	32 A	50
	10 - 4 mm ²			
	10 - 2.5 mm ²			
	16 - 2.5 mm ²			

Jumpers	Type / Cat. No.	Imax	Standard Pack	
Pluggable Jumpers	2 pole	JX6/2	41 A	100
	3 pole	JX6/3	41 A	50
	4 pole	JX6/4	41 A	50
	5 pole	JX6/5	41 A	50
	6 pole			
	8 pole			
	10 pole	JX6/10	41 A	10
	16 pole			
Step Down Jumpers	6 - 2.5 mm ²	JXS6/2.5	24 A	50
	6 - 4 mm ²	JXS6/4	32 A	50
	10 - 6 mm ²	JXS10/6	41 A	50
	10 - 4 mm ²			
	10 - 2.5 mm ²			
	16 - 2.5 mm ²			

Jumpers	Type / Cat. No.	Imax	Standard Pack	
Pluggable Jumpers	2 pole	JX6/2	41 A	100
	3 pole	JX6/3	41 A	50
	4 pole	JX6/4	41 A	50
	5 pole	JX6/5	41 A	50
	6 pole			
	8 pole			
	10 pole	JX6/10	41 A	10
	16 pole			
Step Down Jumpers	6 - 2.5 mm ²	JXS6/2.5	24 A	50
	6 - 4 mm ²	JXS6/4	32 A	50
	10 - 6 mm ²	JXS10/6	41 A	50
	10 - 4 mm ²			
	10 - 2.5 mm ²			
	16 - 2.5 mm ²			

Test Plug			
-----------	--	--	--

Test Plug			
-----------	--	--	--

Test Plug			
-----------	--	--	--

CXG10

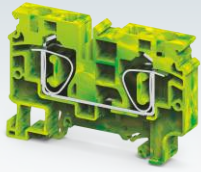

10 x 72.4 mm
49.3 mm / 56.8 mm

IEC	UL - CSA
0.2 - 10.0 mm ²	24 - 6 AWG
0.2 - 10.0 mm ²	24 - 6 AWG
0.5 - 2.5 mm ²	20 - 14 AWG

18 mm



Polyamide 6,6 / 1
8 KV / 3

Type / Cat. No.	Standard Pack
CXG10	50
EPCX10	50
PPCX10	20
CA701-1M / CA701-1M-S	50 m
CA701-15-1M / CA701-15-1M-S	25 m
CA103 / CA104	50
WLX10	50
CA509/K10WHT	100
MC10	10
SCM0.8/4 Blade size: 0.8 x 4 mm	10

Type / Cat. No.	Imax	Standard Pack
JX10/2	57 A	20
JXS10/6	41 A	50
JXS10/4	32 A	50
JXS10/2.5	24 A	50

CSCG16T

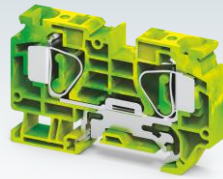

12 x 82 mm
51.2 mm / 58.7 mm

IEC	UL - CSA
1.5 - 16.0 mm ²	16 - 4 AWG
1.5 - 16.0 mm ²	16 - 4 AWG
1.5 - 4.0 mm ²	16 - 12 AWG

20 mm



Polyamide 6,6 / 1
8 KV / 3

Type / Cat. No.	Standard Pack
CSCG16T	50
EPCSC16T	50
CA701-1M / CA701-1M-S	50 m
CA701-15-1M / CA701-15-1M-S	25 m
CA509/K12WHT	100
MC12	10
SCM1.0/5.5 Blade size: 1.0 x 5.5 mm	10

Type / Cat. No.	Imax	Standard Pack

CXG35

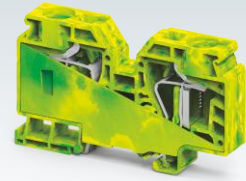

16 x 100 mm
60.3 mm / 67.8 mm

IEC	UL - CSA
2.5 - 35.0 mm ²	14 - 2 AWG
2.5 - 35.0 mm ²	14 - 2 AWG
2.5 - 10.0 mm ²	14 - 8 AWG

23 mm



Polyamide 6,6 / 1
8 KV / 3

Type / Cat. No.	Standard Pack
CXG35	50
CA701-1M / CA701-1M-S	50 m
CA701-15-1M / CA701-15-1M-S	25 m
CA509/K16WHT	100
MC16	10
SCM1.0/5.5 Blade size: 1.0 x 5.5 mm	10

Type / Cat. No.	Imax	Standard Pack

CXG2.5/3

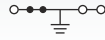
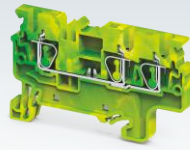

CXG2.5/4

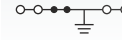
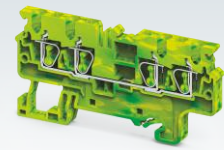

Width (Thickness) x Length		5 x 60.5 mm
Height with DIN 35 x 7.5 / 35 x 15 mm Rail		38.2 mm / 45.7 mm
Connection Possibility as per		
With 1 Conductor per clamp	Stranded / Flexible	0.2 - 2.5 mm ²
	Solid with Ferrule / Lug	0.2 - 4.0 mm ²
With 2 same size Conductors per clamp	with TWIN Ferrule / Lug	0.2 - 2.5 mm ²
Wire Stripping Length		10 mm

IEC		UL - CSA	
0.2 - 2.5 mm ²		24 - 12 AWG	
0.2 - 4.0 mm ²		24 - 10 AWG	
0.2 - 2.5 mm ²		24 - 12 AWG	
0.5 mm ²		20 AWG	

IEC		UL - CSA	
0.2 - 2.5 mm ²		24 - 12 AWG	
0.2 - 4.0 mm ²		24 - 10 AWG	
0.2 - 2.5 mm ²		24 - 12 AWG	
0.5 mm ²		20 AWG	

Approval	
Insulation Material / Material Group	Polyamide 6,6 / 1
Rated Impulse Voltage / Pollution Degree	8 KV / 3

Type / Cat. No.		Standard Pack
CXG2.5/3		100

Type / Cat. No.		Standard Pack
CXG2.5/4		100

Terminal Block	CXG2.5/3	100
End Plate	EPCX2.5/3	50
Partition Plate	PPCX4/3	50
Mounting Rail (Refer Pg. 263 for details)	CA701-1M / CA701-1M-S	50 m
	CA701-15-1M / CA701-15-1M-S	25 m
End Clamp (Refer Pg. 264 for details)	CA103 / CA104	50
Warning Label	WLX2.5	100
Marking Tags (Refer Pg. 268 for details)	CA509/K5WHT	100
Marker Card (Refer Pg. 269 for details)	MC5	10
Screw Driver	SCM0.5/3 Blade size: 0.5 x 3.0 mm	10

Type / Cat. No.		Imax	Standard Pack
JX2.5/2		24 A	100
JX2.5/3		24 A	50
JX2.5/4		24 A	50
JX2.5/5		24 A	50
JX2.5/6		24 A	10
JX2.5/7		24 A	10
JX2.5/8		24 A	10
JX2.5/10		24 A	10
JX2.5/20		24 A	10
JXS6/2.5		24 A	50
JXS10/2.5		24 A	50
JXS16/2.5		24 A	50
TX2.5			20

Type / Cat. No.		Imax	Standard Pack
JX2.5/2		24 A	100
JX2.5/3		24 A	50
JX2.5/4		24 A	50
JX2.5/5		24 A	50
JX2.5/6		24 A	10
JX2.5/7		24 A	10
JX2.5/8		24 A	10
JX2.5/10		24 A	10
JX2.5/20		24 A	10
JXS6/2.5		24 A	50
JXS10/2.5		24 A	50
JXS16/2.5		24 A	50
TX2.5			20

Jumpers			
Pluggable Jumpers	2 pole	JX2.5/2	24 A 100
	3 pole	JX2.5/3	24 A 50
	4 pole	JX2.5/4	24 A 50
	5 pole	JX2.5/5	24 A 50
	6 pole	JX2.5/6	24 A 10
	7 pole	JX2.5/7	24 A 10
	8 pole	JX2.5/8	24 A 10
	10 pole	JX2.5/10	24 A 10
	16 pole		
	20 pole	JX2.5/20	24 A 10
Step Down Jumpers	6 - 2.5 mm ²	JXS6/2.5	24 A 50
	6 - 4 mm ²		
	10 - 6 mm ²		
	10 - 4 mm ²		
	10 - 2.5 mm ²	JXS10/2.5	24 A 50
	16 - 2.5 mm ²	JXS16/2.5	24 A 50
Test Plug		TX2.5	20

Type / Cat. No.		Imax	Standard Pack
JX2.5/2		24 A	100
JX2.5/3		24 A	50
JX2.5/4		24 A	50
JX2.5/5		24 A	50
JX2.5/6		24 A	10
JX2.5/7		24 A	10
JX2.5/8		24 A	10
JX2.5/10		24 A	10
JX2.5/20		24 A	10
JXS6/2.5		24 A	50
JXS10/2.5		24 A	50
JXS16/2.5		24 A	50
TX2.5			20

Type / Cat. No.		Imax	Standard Pack
JX2.5/2		24 A	100
JX2.5/3		24 A	50
JX2.5/4		24 A	50
JX2.5/5		24 A	50
JX2.5/6		24 A	10
JX2.5/7		24 A	10
JX2.5/8		24 A	10
JX2.5/10		24 A	10
JX2.5/20		24 A	10
JXS6/2.5		24 A	50
JXS10/2.5		24 A	50
JXS16/2.5		24 A	50
TX2.5			20

CXG4/3

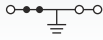
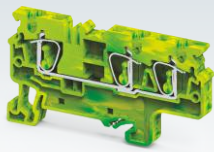

6 x 70.8 mm
38 mm / 45.5 mm

IEC	UL - CSA
0.2 - 4.0 mm ²	24 - 10 AWG
0.2 - 6.0 mm ²	24 - 10 AWG
0.2 - 4.0 mm ²	24 - 10 AWG

0.5 - 1.0 mm² 20 - 18 AWG

10 mm



Polyamide 6,6 / 1

8 KV / 3

Type / Cat. No.	Standard Pack
CXG4/3	50
EPCX4/3	50
PPCX4/3	50
CA701-1M / CA701-1M-S	50 m
CA701-15-1M / CA701-15-1M-S	25 m
CA103 / CA104	50
WLX4	100
CA509/K6WHT	100
MC6	10
SCM0.6/3.5 Blade size: 0.6 x 3.5 mm	10

Type / Cat. No.	I _{max}	Standard Pack
JX4/2	32 A	100
JX4/3	32 A	50
JX4/4	32 A	50
JX4/5	32 A	50
JX4/6	32 A	50
JX4/8	32 A	10
JX4/10	32 A	10
JX4/16	32 A	10

JXS6/4	32 A	50
JXS10/4	32 A	50

CXG4/4

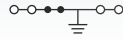
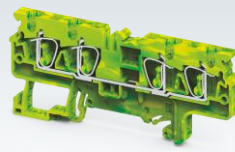

6 x 86.2 mm
38 mm / 45.5 mm

IEC	UL - CSA
0.2 - 4.0 mm ²	24 - 10 AWG
0.2 - 6.0 mm ²	24 - 10 AWG
0.2 - 4.0 mm ²	24 - 10 AWG

0.5 - 1.0 mm² 20 - 18 AWG

10 mm



Polyamide 6,6 / 1

8 KV / 3

Type / Cat. No.	Standard Pack
CXG4/4	50
EPCX4/4	50
PPCX4/4	50
CA701-1M / CA701-1M-S	50 m
CA701-15-1M / CA701-15-1M-S	25 m
CA103 / CA104	50
WLX4	100
CA509/K6WHT	100
MC6	10
SCM0.6/3.5 Blade size: 0.6 x 3.5 mm	10

Type / Cat. No.	I _{max}	Standard Pack
JX4/2	32 A	100
JX4/3	32 A	50
JX4/4	32 A	50
JX4/5	32 A	50
JX4/6	32 A	50
JX4/8	32 A	10
JX4/10	32 A	10
JX4/16	32 A	10

JXS6/4	32 A	50
JXS10/4	32 A	50

CXG6/3

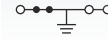
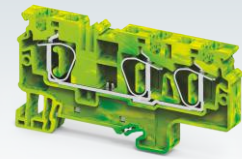

8 x 82.2 mm
42.2 mm / 50.5 mm

IEC	UL - CSA
0.2 - 6.0 mm ²	24 - 8 AWG
0.2 - 6.0 mm ²	24 - 8 AWG
0.2 - 6.0 mm ²	24 - 8 AWG

0.5 - 1.5 mm² 20 - 16 AWG

14 mm



Polyamide 6,6 / 1

8 KV / 3

Type / Cat. No.	Standard Pack
CXG6/3	50
EPCX6/3	50
CA701-1M / CA701-1M-S	50 m
CA701-15-1M / CA701-15-1M-S	25 m
CA103 / CA104	50
WLX6	100
CA509/K8WHT	100
MC8	10
SCM0.8/4 Blade size: 0.8 x 4 mm	10

Type / Cat. No.	I _{max}	Standard Pack
JX6/2	41 A	100
JX6/3	41 A	50
JX6/4	41 A	50
JX6/5	41 A	50
JX6/10	41 A	10

JXS6/2.5	34 A	50
JXS6/4	32 A	50
JXS10/6	41 A	50

VIRTUAL **config**

DESIGN

DOCUMENT

MANUFACTURE

DELIVER

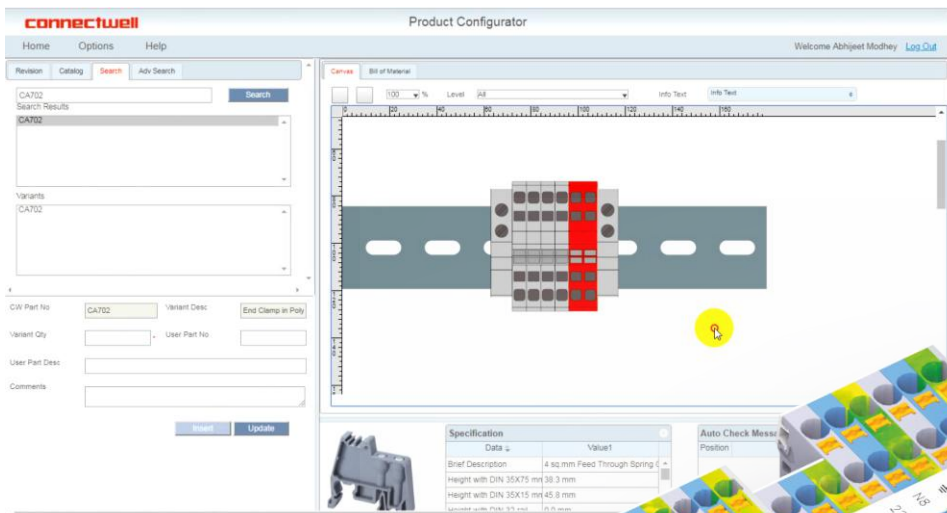

FEATURES

- Free online tool for Terminal Block configuration
- Easy to use software, menu driven, no CAD licencing required
- 2D & 3D output drawing generation
- Complete BOM documentation
- Short manufacturing lead time
- Standardized packaging for configured rail assemblies



Scan to Login
Virtual Config

<http://www.connectwell.com/Global/product-configurator.aspx>

MULTIPLE LEVEL TERMINAL BLOCKS

CXDL2.5 is a compact double level Spring Clamp Terminal Block. This Terminal Block is used in high density wiring applications. Interconnections / shorting is possible at both levels. This Terminal Block is suitable for 1000 V rating.

CXDL2.5(I.S) is double level internally shorted Terminal Block. This is an ideal choice for distribution application.

CXDLG2.5 is double level spring clamp Terminal Block with an additional grounding point for terminating grounding cables on the lower level of the terminal block. The earth connection is made by snapping the terminal on the Din rail. This separate connection point is appropriately identified by the green-yellow imprint on its top.

CXDLG2.5(I.S) is double level ground Terminal Block with 4 connection points for grounding wires. It is available in a standard green-yellow colour to indicate the grounding connection.



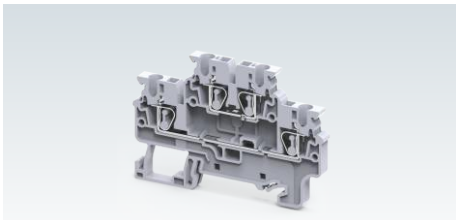

The terminals with  & IECEx approval can be used in potentially explosive atmosphere. For detailed information refer page 289.

Width (Thickness) x Length		5 x 71 mm
Height with DIN 35 x 7.5 / 35 x 15 mm Rail		49.5 mm / 57 mm
Connection Possibility as per		
With 1 Conductor per clamp	Stranded / Flexible	0.2 - 2.5 mm ²
	Solid	0.2 - 4.0 mm ²
		with Ferrule / Lug
With 2 same size Conductors per clamp	with TWIN Ferrule / Lug	0.2 - 2.5 mm ²
		0.5 mm ²
Wire Stripping Length		10 mm
Ratings As Per		
Voltage		IEC60947-7-1 UL-1059 CSA22.2-158 IEC60079-7
Current		1000 V 600 V 600 V 630 V
Approval		24 A 20 A 20 A 21 A
Insulation Material / Material Group		
Rated Impulse Voltage / Pollution Degree		8 KV / 3

CXDL2.5



IEC		UL - CSA	
0.2 - 2.5 mm ²		24 - 12 AWG	
0.2 - 4.0 mm ²		24 - 10 AWG	
0.2 - 2.5 mm ²		24 - 12 AWG	
0.5 mm ²		20 AWG	
10 mm			
IEC60947-7-1 UL-1059 CSA22.2-158 IEC60079-7			
1000 V	600 V	600 V	630 V
24 A	20 A	20 A	21 A
Polyamide 6,6 / 1			
8 KV / 3			

Terminal Block	Grey	CXDL2.5	50	
	Blue	CXDL2.5BU	50	
	Red	CXDL2.5R	50	
	Yellow	CXDL2.5Y	50	
	Black	CXDL2.5BK	50	
	Green	CXDL2.5GN	50	
	Ground / Earth	CXDLG2.5(I.S.) (Refer Pg. 66 for Details)	50	
End Plate		EPCXDL2.5	50	
Mounting Rail (Refer Pg. 263 for details)		CA701-1M / CA701-1M-S	50 m	
End Clamp (Refer Pg. 264 for details)		CA701-15-1M / CA701-15-1M-S	25 m	
Warning Label		CA103 / CA104	50	
Marking Tags (Refer Pg. 268 for details)		WLX2.5	100	
Marker Card (Refer Pg. 269 for details)		CA509/K5WHT	100	
Screw Driver		MC5	10	
Dual Marker Carrier		SCM0.5/3 Blade size: 0.5 x 3.0 mm	10	
Jumpers		TM5	50	
Pluggable Jumpers	2 pole	JX2.5/2	24 A	100
	3 pole	JX2.5/3	24 A	50
	4 pole	JX2.5/4	24 A	50
	5 pole	JX2.5/5	24 A	50
	6 pole	JX2.5/6	24 A	10
	7 pole	JX2.5/7	24 A	10
	8 pole	JX2.5/8	24 A	10
	10 pole	JX2.5/10	24 A	10
20 pole	JX2.5/20	24 A	10	
Test Plug		TX2.5	20	

Type / Cat. No.	Standard Pack	
CXDL2.5	50	
CXDL2.5BU	50	
CXDL2.5R	50	
CXDL2.5Y	50	
CXDL2.5BK	50	
CXDL2.5GN	50	
CXDLG2.5(I.S.) (Refer Pg. 66 for Details)	50	
EPCXDL2.5	50	
CA701-1M / CA701-1M-S	50 m	
CA701-15-1M / CA701-15-1M-S	25 m	
CA103 / CA104	50	
WLX2.5	100	
CA509/K5WHT	100	
MC5	10	
SCM0.5/3 Blade size: 0.5 x 3.0 mm	10	
TM5	50	
Type / Cat. No.	I _{max}	Standard Pack
JX2.5/2	24 A	100
JX2.5/3	24 A	50
JX2.5/4	24 A	50
JX2.5/5	24 A	50
JX2.5/6	24 A	10
JX2.5/7	24 A	10
JX2.5/8	24 A	10
JX2.5/10	24 A	10
JX2.5/20	24 A	10
TX2.5		20

CXDL2.5(I.S)

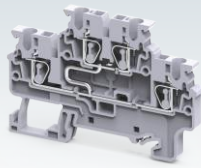

5 x 71 mm
49.5 mm / 57 mm

IEC	UL - CSA
0.2 - 2.5 mm ²	24 - 12 AWG
0.2 - 4.0 mm ²	24 - 10 AWG
0.2 - 2.5 mm ²	24 - 12 AWG

0.5 mm² 20 AWG

10 mm

IEC60947-7-1 UL-1059 CSA22.2-158 IEC60079-7

1000 V	600 V	600 V	630 V
24 A	20 A	20 A	21 A



Polyamide 6,6 / 1

8 KV / 3

CXDLG2.5

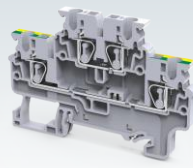

5 x 71 mm
49.5 mm / 57 mm

IEC	UL - CSA
0.2 - 2.5 mm ²	24 - 12 AWG
0.2 - 4.0 mm ²	24 - 10 AWG
0.2 - 2.5 mm ²	24 - 12 AWG

0.5 mm² 20 AWG

10 mm

IEC60947-7-1 UL-1059 CSA22.2-158 IEC60079-7

1000 V	600 V	600 V	630 V
Top Level - 24 A	Top Level - 20 A		Top Level - 21 A



Polyamide 6,6 / 1

8 KV / 3

CXDLG2.5(I.S)

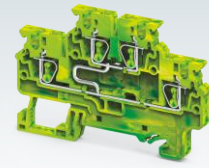

5 x 71 mm
49.5 mm / 57 mm

IEC	UL - CSA
0.2 - 2.5 mm ²	24 - 12 AWG
0.2 - 4.0 mm ²	24 - 10 AWG
0.2 - 2.5 mm ²	24 - 12 AWG

0.5 mm² 20 AWG

10 mm

IEC60947-7-2

1000 V	600 V	600 V	630 V



Polyamide 6,6 / 1

8 KV / 3

Type / Cat. No.	Standard Pack
CXDL2.5(I.S)	50

EPCXDL2.5	50
CA701-1M / CA701-1M-S	50 m
CA701-15-1M / CA701-15-1M-S	25 m
CA103 / CA104	50
WLX2.5	100
CA509/K5WHT	100
MC5	10
SCM0.5/3 Blade size: 0.5 x 3.0 mm	10
TM5	50

Type / Cat. No.	I _{max}	Standard Pack
JX2.5/2	24 A	100
JX2.5/3	24 A	50
JX2.5/4	24 A	50
JX2.5/5	24 A	50
JX2.5/6	24 A	10
JX2.5/7	24 A	10
JX2.5/8	24 A	10
JX2.5/10	24 A	10
JX2.5/20	24 A	10
TX2.5		20

Type / Cat. No.	Standard Pack
CXDLG2.5	50

EPCXDL2.5	50
CA701-1M / CA701-1M-S	50 m
CA701-15-1M / CA701-15-1M-S	25 m
CA103 / CA104	50
WLX2.5	100
CA509/K5WHT	100
MC5	10
SCM0.5/3 Blade size: 0.5 x 3.0 mm	10
TM5	50

Type / Cat. No.	I _{max}	Standard Pack
JX2.5/2	24 A	100
JX2.5/3	24 A	50
JX2.5/4	24 A	50
JX2.5/5	24 A	50
JX2.5/6	24 A	10
JX2.5/7	24 A	10
JX2.5/8	24 A	10
JX2.5/10	24 A	10
JX2.5/20	24 A	10
TX2.5		20

Type / Cat. No.	Standard Pack

CXDLG2.5(I.S)	50
EPCXDL2.5	50
CA701-1M / CA701-1M-S	50 m
CA701-15-1M / CA701-15-1M-S	25 m
CA103 / CA104	50
WLX2.5	100
CA509/K5WHT	100
MC5	10
SCM0.5/3 Blade size: 0.5 x 3.0 mm	10
TM5	50

Type / Cat. No.	I _{max}	Standard Pack
JX2.5/2	24 A	100
JX2.5/3	24 A	50
JX2.5/4	24 A	50
JX2.5/5	24 A	50
JX2.5/6	24 A	10
JX2.5/7	24 A	10
JX2.5/8	24 A	10
JX2.5/10	24 A	10
JX2.5/20	24 A	10
TX2.5		20

MULTIPLE LEVEL TERMINAL BLOCKS

CXDL2.5/3 is a compact double level Spring Clamp Terminal Block. This Terminal Block is used in high density wiring applications. Interconnections / shorting is possible at both levels. This Terminal Block is suitable for 1000 V rating.





CXDL2.5/3(I.S) is double level internally shorted Terminal Block. This is an ideal choice for distribution application.

CXDLG2.5/3 is double level spring clamp Terminal Block with an additional grounding point for terminating grounding cables on the lower level of the terminal block. The earth connection is made by snapping the terminal on the Din rail. This separate connection point is appropriately identified by the green-yellow imprint on its top.

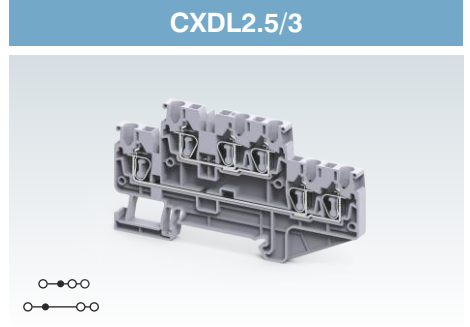
CXDLG2.5/3(I.S) is double level ground Terminal Block with 4 connection points for grounding wires. It is available in a standard green-yellow colour to indicate the grounding connection.

Width (Thickness) x Length		5 x 91.5 mm	
Height with DIN 35 x 7.5 / 35 x 15 mm Rail		49.5 mm / 57 mm	
Connection Possibility as per		IEC	UL - CSA
With 1 Conductor per clamp	Stranded / Flexible	0.2 - 2.5 mm ²	24 - 12 AWG
	Solid with Ferrule / Lug	0.2 - 4.0 mm ²	24 - 10 AWG
With 2 same size Conductors per clamp	with TWIN Ferrule / Lug	0.2 - 2.5 mm ²	24 - 12 AWG
Wire Stripping Length		10 mm	
Ratings As Per		IEC60947-7-1 UL-1059	
Voltage		1000 V	600 V
Current		24 A	20 A
Approval			
Insulation Material / Material Group		Polyamide 6,6 / 1	
Rated Impulse Voltage / Pollution Degree		8 KV / 3	

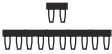

		Type / Cat. No.	Standard Pack		
Terminal Block		CXDL2.5/3	50		
End Plate		EPCXDL2.5/3	50		
Mounting Rail (Refer Pg. 263 for details)		CA701-1M / CA701-1M-S CA701-15-1M / CA701-15-1M-S	50 m 25 m		
End Clamp (Refer Pg. 264 for details)		CA103 / CA104	50		
Warning Label		WLX2.5	100		
Marking Tags (Refer Pg. 268 for details)		CA509/K5WHT	100		
Marker Card (Refer Pg. 269 for details)		MC5	10		
Screw Driver		SCM0.5/3 Blade size: 0.5 x 3.0 mm	10		
Dual Marker Carrier		TM5	50		
Jumpers		Type / Cat. No.	I _{max}	Standard Pack	
Pluggable Jumpers		2 pole	JX2.5/2	24 A	100
		3 pole	JX2.5/3	24 A	50
		4 pole	JX2.5/4	24 A	50
		5 pole	JX2.5/5	24 A	50
		6 pole	JX2.5/6	24 A	10
		7 pole	JX2.5/7	24 A	10
		8 pole	JX2.5/8	24 A	10
		10 pole	JX2.5/10	24 A	10
		20 pole	JX2.5/20	24 A	10
		Test Plug		TX2.5	

CXDL2.5/3(I.S)

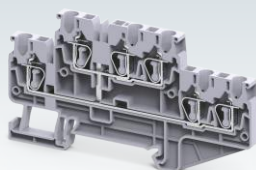

5 x 91.5 mm

49.5 mm / 57 mm

IEC	UL - CSA
0.2 - 2.5 mm ²	24 - 12 AWG
0.2 - 4.0 mm ²	24 - 10 AWG
0.2 - 2.5 mm ²	24 - 12 AWG

0.5 mm²

20 AWG

10 mm

IEC60947-7-1 UL-1059

1000 V

600 V

24 A

20 A



Polyamide 6,6 / 1

8 KV / 3

CXDLG2.5/3

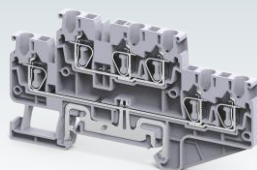

5 x 91.5 mm

49.5 mm / 57 mm

IEC	UL - CSA
0.2 - 2.5 mm ²	24 - 12 AWG
0.2 - 4.0 mm ²	24 - 10 AWG
0.2 - 2.5 mm ²	24 - 12 AWG

0.5 mm²

20 AWG

10 mm

IEC60947-7-1 UL-1059

1000 V

600 V

Top Level - 24 A Top Level - 20 A



Polyamide 6,6 / 1

8 KV / 3

CXDLG2.5/3(I.S)

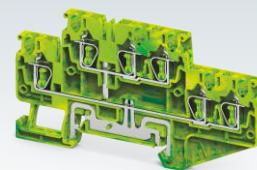

5 x 91.5 mm

49.5 mm / 57 mm

IEC	UL - CSA
0.2 - 2.5 mm ²	24 - 12 AWG
0.2 - 4.0 mm ²	24 - 10 AWG
0.2 - 2.5 mm ²	24 - 12 AWG

0.5 mm²

20 AWG

10 mm

IEC60947-7-2

1000 V

600 V

24 A

20 A



Polyamide 6,6 / 1

8 KV / 3

Type / Cat. No.	Standard Pack
CXDL2.5/3(I.S)	50
EPCXDL2.5/3	50
CA701-1M / CA701-1M-S	50 m
CA701-15-1M / CA701-15-1M-S	25 m
CA103 / CA104	50
WLX2.5	100
CA509/K5WHT	100
MC5	10
SCM0.5/3 Blade size: 0.5 x 3.0 mm	10
TM5	50

Type / Cat. No.	I _{max}	Standard Pack
JX2.5/2	24 A	100
JX2.5/3	24 A	50
JX2.5/4	24 A	50
JX2.5/5	24 A	50
JX2.5/6	24 A	10
JX2.5/7	24 A	10
JX2.5/8	24 A	10
JX2.5/10	24 A	10
JX2.5/20	24 A	10
TX2.5		20

Type / Cat. No.	Standard Pack
CXDLG2.5/3	50
EPCXDL2.5/3	50
CA701-1M / CA701-1M-S	50 m
CA701-15-1M / CA701-15-1M-S	25 m
CA103 / CA104	50
WLX2.5	100
CA509/K5WHT	100
MC5	10
SCM0.5/3 Blade size: 0.5 x 3.0 mm	10
TM5	50

Type / Cat. No.	I _{max}	Standard Pack
JX2.5/2	24 A	100
JX2.5/3	24 A	50
JX2.5/4	24 A	50
JX2.5/5	24 A	50
JX2.5/6	24 A	10
JX2.5/7	24 A	10
JX2.5/8	24 A	10
JX2.5/10	24 A	10
JX2.5/20	24 A	10
TX2.5		20

Type / Cat. No.	Standard Pack
CXDLG2.5/3(I.S)	50
EPCXDL2.5/3	50
CA701-1M / CA701-1M-S	50 m
CA701-15-1M / CA701-15-1M-S	25 m
CA103 / CA104	50
WLX2.5	100
CA509/K5WHT	100
MC5	10
SCM0.5/3 Blade size: 0.5 x 3.0 mm	10
TM5	50

Type / Cat. No.	I _{max}	Standard Pack
JX2.5/2	24 A	100
JX2.5/3	24 A	50
JX2.5/4	24 A	50
JX2.5/5	24 A	50
JX2.5/6	24 A	10
JX2.5/7	24 A	10
JX2.5/8	24 A	10
JX2.5/10	24 A	10
JX2.5/20	24 A	10
TX2.5		20

DISCONNECT & TEST TERMINAL BLOCKS

CXK series terminals are compact disconnect spring clamp Terminal Blocks.

In these Terminal Blocks disconnection is achieved by opening the insulated knife (blade) contact in the middle of the terminal.

Separate testing points are provided on top for inserting standard Ø2.3 mm test probes.

Alternate and continuous bridging can be done with standard pluggable jumpers.

Multi connect 3 & 4 wire terminals eliminate reliability problems encountered when there is a need to connect multiple wires in a single Terminal Block.

The terminals with  & IECEx approval can be used in potentially explosive atmosphere. For detailed information refer page 289.

CXK2.5

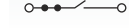
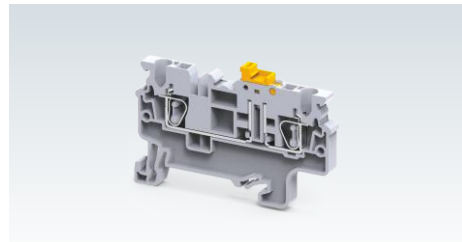

Width (Thickness) x Length	5 x 60.5 mm			
Height with DIN 35 x 7.5 / 35 x 15 mm Rail	42.4 mm / 49.9 mm			
Connection Possibility as per	IEC		UL - CSA	
With 1 Conductor per clamp	Stranded / Flexible	0.2 - 2.5 mm ²	24 - 12 AWG	
	Solid	0.2 - 4.0 mm ²	24 - 10 AWG	
	with Ferrule / Lug	0.2 - 2.5 mm ²	24 - 12 AWG	
With 2 same size Conductors per clamp	with TWIN Ferrule / Lug	0.5 mm ²	20 AWG	
Wire Stripping Length	10 mm			
Ratings As Per	IEC60947-7-1	UL-1059	CSA22.2-158	IEC60079-7
Voltage	1000 V	600 V	600 V	630 V
Current	20 A	16 A	16 A	17 A
Approval				
Insulation Material / Material Group	Polyamide 6,6 / 1			
Rated Impulse Voltage / Pollution Degree	6 KV / 3			

	Type / Cat. No.	Standard Pack
Terminal Block	CXK2.5 CXK2.5BU	100 100
End Plate	EPCX2.5/3	50
Partition Plate	PPCX4/3	50
Mounting Rail (Refer Pg. 263 for details)	CA701-1M / CA701-1M-S CA701-15-1M / CA701-15-1M-S	50 m 25 m
End Clamp (Refer Pg. 264 for details)	CA103 / CA104	50
Warning Label	WLX2.5	100
Marking Tags (Refer Pg. 268 for details)	CA509/K5WHT	100
Disconnecting Marker	CA509/K4WHT	100
Marker Card (Refer Pg. 269 for details)	MC5	10
Screw Driver	SCM0.5/3 Blade size: 0.5 x 3 mm	10

	Type / Cat. No.	I _{max}	Standard Pack	
Pluggable Jumpers	2 pole	JX2.5/2	24 A	100
	3 pole	JX2.5/3	24 A	50
	4 pole	JX2.5/4	24 A	50
	5 pole	JX2.5/5	24 A	50
	6 pole	JX2.5/6	24 A	10
	7 pole	JX2.5/7	24 A	10
	8 pole	JX2.5/8	24 A	10
	10 pole	JX2.5/10	24 A	10
	16 pole			
	20 pole	JX2.5/20	24 A	10
Test Plug	TX2.5		20	

CXK2.5/4

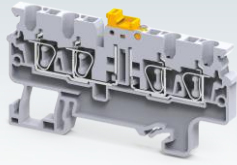

5 x 73 mm

38.2 mm / 45.7 mm

IEC	UL - CSA
0.2 - 2.5 mm ²	24 - 12 AWG
0.2 - 4.0 mm ²	24 - 10 AWG
0.2 - 2.5 mm ²	24 - 12 AWG

0.5 mm² 20 AWG

10 mm

IEC60947-7-1 UL-1059 IEC60079-7

1000 V	600 V	630 V
20 A	16 A	17 A



Polyamide 6,6 / 1

6 KV / 3

Type / Cat. No.	Standard Pack
CXK2.5/4	50
CXK2.5/4BU	50
EPCX2.5/4	50
PPCX4/4	50
CA701-1M / CA701-1M-S	50 m
CA701-15-1M / CA701-15-1M-S	25 m
CA103 / CA104	50
WLX2.5	100
CA509/K5WHT	100
CA509/K4WHT	100
MC5	10
SCM0.5/3 Blade size: 0.5 x 3 mm	10

Type / Cat. No.	I _{max}	Standard Pack
JX2.5/2	24 A	100
JX2.5/3	24 A	50
JX2.5/4	24 A	50
JX2.5/5	24 A	50
JX2.5/6	24 A	10
JX2.5/7	24 A	10
JX2.5/8	24 A	10
JX2.5/10	24 A	10
JX2.5/20	24 A	10
TX2.5		20

CXK4

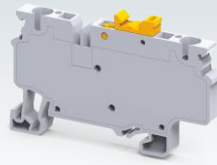

6 x 65.7 mm

42.7 mm / 50.2 mm

IEC	UL - CSA
0.2 - 4.0 mm ²	24 - 10 AWG
0.2 - 6.0 mm ²	
0.2 - 4.0 mm ²	24 - 10 AWG

0.5 - 1.0 mm² 20 - 18 AWG

10 mm

IEC60947-7-1 UL-1059

1000 V	300 V
22 A	22 A



Polyamide 6,6 / 1

8 KV / 3

Type / Cat. No.	Standard Pack
CXK4	100
CXK4BU	100
PPCX4/4	50
CA701-1M / CA701-1M-S	50 m
CA701-15-1M / CA701-15-1M-S	25 m
CA103 / CA104	50
WLX4	50
CA509/K6WHT	100
CA509/K5WHT	100
MC5 / MC6	10
SCM0.6/3.5 Blade size: 0.6 x 3.5 mm	10

Type / Cat. No.	I _{max}	Standard Pack
JX4/2	32 A	100
JX4/3	32 A	50
JX4/4	32 A	50
JX4/5	32 A	50
JX4/6	32 A	50
JX4/8	32 A	10
JX4/10	32 A	10
JX4/16	32 A	10

CXK4/3



6 x 86.2 mm

42.7 mm / 50.2 mm

IEC	UL - CSA
0.2 - 4.0 mm ²	24 - 10 AWG
0.2 - 6.0 mm ²	
0.2 - 4.0 mm ²	24 - 10 AWG

0.5 - 1.0 mm² 20 - 18 AWG

10 mm

IEC60947-7-1 UL-1059

1000 V	600 V
22 A	30 A



Polyamide 6,6 / 1

8 KV / 3

Type / Cat. No.	Standard Pack
CXK4/3	50
CXK4/3BU	50
EPCX4/4	50
PPCX4/4	50
CA701-1M / CA701-1M-S	50 m
CA701-15-1M / CA701-15-1M-S	25 m
CA103 / CA104	50
WLX4	50
CA509/K6WHT	100
CA509/K5WHT	100
MC5 / MC6	10
SCM0.6/3.5 Blade size: 0.6 x 3.5 mm	10

Type / Cat. No.	I _{max}	Standard Pack
JX4/2	32 A	100
JX4/3	32 A	50
JX4/4	32 A	50
JX4/5	32 A	50
JX4/6	32 A	50
JX4/8	32 A	10
JX4/10	32 A	10
JX4/16	32 A	10

MICRO SPRING CLAMP TERMINAL BLOCKS

These Terminal Blocks are an excellent solution for extremely compact wiring applications. The Terminal Blocks DIN 15 type (DIN 2) rails.





CXM series terminals have standard top wire entry and cross connection can be achieved by using pluggable jumpers.

CMS2.5 series terminal has a side wire entry configuration.

The terminals with  & IECEx approval can be used in potentially explosive atmosphere. For detailed information refer page 289.

Width (Thickness) x Length		5 x 37 mm			
Height with DIN 15 mm Rail		35 mm			
Connection Possibility as per		IEC	UL - CSA		
With 1 Conductor per clamp	Stranded / Flexible	0.2 - 2.5 mm ²	24 - 12 AWG		
	Solid with Ferrule / Lug	0.2 - 4.0 mm ²	24 - 10 AWG		
With 2 same size Conductors per clamp	with TWIN Ferrule / Lug	0.2 - 2.5 mm ²	24 - 12 AWG		
Wire Stripping Length		10 mm			
Ratings As Per		IEC60947-7-1	UL-1059	CSA22.2-158	IEC60079-7
Voltage		1000 V	600 V	600 V	630 V
Current		24 A	20 A	20 A	21 A
Approval					
Insulation Material / Comparative Tracking Index		Polyamide 66 / 1			
Rated Impulse Voltage / Pollution Degree		8 KV / 3			



		Type / Cat. No.	I _{max}	Standard Pack
Terminal Block	Grey	CXM2.5		100
	Blue	CXM2.5BU		100
	Red	CXM2.5R		100
	Yellow	CXM2.5Y		100
	Black	CXM2.5BK		100
	Green	CXM2.5GN		100
End Plate		EPCXM2.5		50
Mounting Rail (Refer Pg. 263 for details)		CA601		50 m
End Clamp (Refer Pg. 264 for details)		CA602		50
Actuator for actuating the spring clamp		SCA2.5		1
Marking Tag (Refer Pg. 268 for details)		MS5WHT		100
Marker Card (Refer Pg. 269 for details)		MC5		10
Screw Driver		SCM0.5/3	Blade size: 0.5 x 3 mm	10

Jumpers		Type / Cat. No.	I _{max}	Standard Pack
Pluggable Jumpers	2 pole	JX2.5/2	24 A	100
	3 pole	JX2.5/3	24 A	50
	4 pole	JX2.5/4	24 A	50
	5 pole	JX2.5/5	24 A	50
	6 pole	JX2.5/6	24 A	10
	7 pole	JX2.5/7	24 A	10
	8 pole	JX2.5/8	24 A	10
	10 pole	JX2.5/10	24 A	10
	20 pole	JX2.5/20	24 A	10
	Test Plug		TX2.5	

CXMG2.5

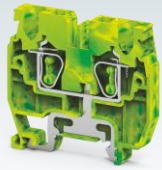

For DIN 15 Rail Mounting

5 x 37 mm

35 mm

IEC	UL - CSA
0.2 - 2.5 mm ²	24 - 12 AWG
0.2 - 4.0 mm ²	24 - 10 AWG
0.2 - 2.5 mm ²	24 - 12 AWG

0.5 mm²

20 AWG

10 mm

IEC60947-7-2 UL-1059



Polyamide 66 / 1

8 KV / 3

Type / Cat. No.	Standard Pack
CXMG2.5	100
EPCXM2.5	50
CA601	50 m
CA602	50
SCA2.5	1
MS5WHT	100
MC5	10
SCM0.5/3 Blade size: 0.5 x 3 mm	10

Type / Cat. No.	I _{max}	Standard Pack
JX2.5/2	24 A	100
JX2.5/3	24 A	50
JX2.5/4	24 A	50
JX2.5/5	24 A	50
JX2.5/6	24 A	10
JX2.5/7	24 A	10
JX2.5/8	24 A	10
JX2.5/10	24 A	10
JX2.5/20	24 A	10
TX2.5		20

CMS2.5



For DIN 15 Rail Mounting

5 x 31 mm

30.15 mm

IEC	UL - CSA
0.2 - 2.5 mm ²	24 - 12 AWG
0.2 - 4.0 mm ²	24 - 10 AWG
0.2 - 2.5 mm ²	24 - 12 AWG

0.5 mm²

20 AWG

9 mm

IEC60947-7-1 UL-1059 CSA22.2-158 IEC60079-7

800 V	300 V	300 V	400 V
24 A	20 A	20 A	21 A



Polyamide 6,6 / 1

6 KV / 3

Type / Cat. No.	Standard Pack
CMS2.5	100
CMS2.5BU	100
CMS2.5R	100
CMS2.5Y	100
CMS2.5BK	100
CMS2.5GN	100
EPCMS2.5	50
CA601	50 m
CA602	50
CA509/K5WHT	100
MC5	10
SCM0.5/3 Blade size: 0.5 x 3 mm	10

Type / Cat. No.	I _{max}	Standard Pack

SIDE ENTRY FEED THROUGH TERMINAL BLOCKS

CXS series Terminal Blocks, have a side wire entry configuration.







This Terminal Block can be actuated from side as well as from the top using standard screw driver.

It is specially designed for mounting location with low installation height.

The terminals with  & IECEx approval can be used in potentially explosive atmosphere. For detailed information refer page 289.

Width (Thickness) x Length	5 x 45.9 mm			
Height with DIN 35 x 7.5 / 35 x 15 mm Rail	43.3 mm / 50.8 mm			
Connection Possibility as per	IEC		UL - CSA	
With 1 Conductor per clamp	Stranded / Flexible		24 - 12 AWG	
	Solid		24 - 10 AWG	
	with Ferrule / Lug		24 - 12 AWG	
With 2 same size Conductors per clamp	with TWIN Ferrule / Lug		20 AWG	
Wire Stripping Length	9 mm			
Ratings As Per	IEC60947-7-1	UL-1059	CSA22.2-158	IEC60079-7
Voltage	1000 V	600 V	600 V	630 V
Current	24 A	20 A	20 A	21 A
Approval				
Insulation Material / Material Group	Polyamide 6,6 / 1			
Rated Impulse Voltage / Pollution Degree	8 KV / 3			



		Type / Cat. No.	Standard Pack	
Terminal Block	Grey	CXS2.5	50	
	Blue	CXS2.5BU	50	
	Red	CXS2.5R	50	
	Yellow	CXS2.5Y	50	
	Black	CXS2.5BK	50	
	Green	CXS2.5GN	50	
	Ground / Earth	CXSG2.5 (Refer Pg. 77 for Details)	50	
	End Plate		EPCXS2.5	50
Mounting Rail (Refer Pg. 263 for details)		CA701-1M / CA701-1M-S CA701-15-1M / CA701-15-1M-S	50 m 25 m	
End Clamp (Refer Pg. 264 for details)		CA103 / CA104	50	
Marking Tags (Refer Pg. 268 for details)		CA509/K5WHT	100	
Marker Card (Refer Pg. 269 for details)		MC5	10	
Screw Driver		SCM0.5/3 Blade size: 0.5 x 3 mm	10	
Jumpers		Type / Cat. No.	I_{max}	Standard Pack
Pluggable Jumpers	2 pole	JX2.5/2	24 A	100
	3 pole	JX2.5/3	24 A	50
	4 pole	JX2.5/4	24 A	50
	5 pole	JX2.5/5	24 A	50
	6 pole	JX2.5/6	24 A	10
	7 pole	JX2.5/7	24 A	10
	8 pole	JX2.5/8	24 A	10
	10 pole	JX2.5/10	24 A	10
	16 pole			
	20 pole	JX2.5/20	24 A	10
Test Plug		TX2.5		20

CXS4

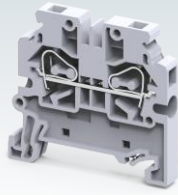

6 x 45.9 mm

43.3 mm / 50.8 mm

IEC	UL - CSA
0.2 - 4.0 mm ²	24 - 10 AWG
0.2 - 6.0 mm ²	
0.2 - 4.0 mm ²	24 - 10 AWG
0.5 - 1.0 mm ²	20 - 18 AWG

10 mm

IEC60947-7-1 UL-1059

1000 V	600 V		
32 A	30 A		



Polyamide 6,6 / 1

8 KV / 3

CXS6



8 x 55.4 mm

49.8 mm / 57.3 mm

IEC	UL - CSA
0.2 - 6.0 mm ²	24 - 8 AWG
0.2 - 6.0 mm ²	
0.2 - 6.0 mm ²	24 - 8 AWG
0.5 - 1.5 mm ²	20 - 16 AWG

14 mm

IEC60947-7-1 UL-1059

1000 V	600 V		
41 A	50 A		



Polyamide 6,6 / 1

8 KV / 3

CXS10

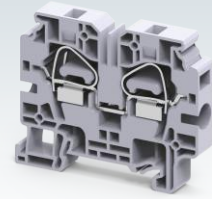

10 x 65.3 mm

53.8 mm / 61.3 mm

IEC	UL - CSA
0.2 - 10.0 mm ²	24 - 6 AWG
0.2 - 10.0 mm ²	
0.2 - 10.0 mm ²	24 - 6 AWG
0.5 - 2.5 mm ²	20 - 14 AWG

18 mm

IEC60947-7-1 UL-1059

1000 V	600 V		
41 A	50 A		



Polyamide 6,6 / 1

8 KV / 3

Type / Cat. No.	Standard Pack
CXS4	50
CXSG4 (Refer Pg. 77 for Details)	50
EPCXS2.5	50
CA701-1M / CA701-1M-S	50 m
CA701-15-1M / CA701-15-1M-S	25 m
CA103 / CA104	50
CA509/K6WHT	100
MC6	10
SCM0.6/3.5 Blade size: 0.6 x 3.5 mm	10

Type / Cat. No.	I _{max}	Standard Pack
JX4/2	32 A	100
JX4/3	32 A	50
JX4/4	32 A	50
JX4/5	32 A	50
JX4/6	32 A	50
JX4/8	32 A	10
JX4/10	32 A	10
JX4/16	32 A	10

Type / Cat. No.	Standard Pack
CXS6	50
EPCXS6	50
CA701-1M / CA701-1M-S	50 m
CA701-15-1M / CA701-15-1M-S	25 m
CA103 / CA104	50
CA509/K8WHT	100
MC8	10
SCM0.8/4 Blade size: 0.8 x 4 mm	10

Type / Cat. No.	I _{max}	Standard Pack
JX6/2	41 A	100
JX6/3	41 A	50
JX6/4	41 A	50
JX6/5	41 A	50
JX6/10	41 A	10

Type / Cat. No.	Standard Pack
CXS10	50
EPCXS10	50
CA701-1M / CA701-1M-S	50 m
CA701-15-1M / CA701-15-1M-S	25 m
CA103 / CA104	50
CA509/K10WHT	100
MC10	10
SCM0.8/4 Blade size: 0.8 x 4 mm	10

Type / Cat. No.	I _{max}	Standard Pack
JX10/2	57 A	20

CXSG2.5



CXSG4

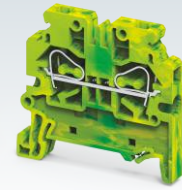

Width (Thickness) x Length	5 x 45.9 mm	
Height with DIN 35 x 7.5 / 35 x 15 mm Rail	43.3 mm / 50.8 mm	
Connection Possibility as per	IEC	UL - CSA
With 1 Conductor per clamp	Stranded / Flexible	0.2 - 2.5 mm ²
	Solid	0.2 - 4.0 mm ²
	with Ferrule / Lug	0.2 - 2.5 mm ²
With 2 same size Conductors per clamp	with TWIN Ferrule / Lug	0.5 mm ²
Wire Stripping Length	9 mm	
Ratings As Per	IEC60947-7-2	
Voltage		
Current		
Approval		
Insulation Material / Material Group	Polyamide 6,6 / 1	
Rated Impulse Voltage / Pollution Degree	8 KV / 3	

Width (Thickness) x Length	6 x 45.9 mm	
Height with DIN 35 x 7.5 / 35 x 15 mm Rail	43.3 mm / 50.8 mm	
Connection Possibility as per	IEC	UL - CSA
With 1 Conductor per clamp	Stranded / Flexible	0.2 - 4.0 mm ²
	Solid	0.2 - 6.0 mm ²
	with Ferrule / Lug	0.2 - 4.0 mm ²
With 2 same size Conductors per clamp	with TWIN Ferrule / Lug	0.5 - 1.0 mm ²
Wire Stripping Length	10 mm	
Ratings As Per	IEC60947-7-2	
Voltage		
Current		
Approval		
Insulation Material / Material Group	Polyamide 6,6 / 1	
Rated Impulse Voltage / Pollution Degree	8 KV / 3	

Width (Thickness) x Length	6 x 45.9 mm	
Height with DIN 35 x 7.5 / 35 x 15 mm Rail	43.3 mm / 50.8 mm	
Connection Possibility as per	IEC	UL - CSA
With 1 Conductor per clamp	Stranded / Flexible	0.2 - 4.0 mm ²
	Solid	0.2 - 6.0 mm ²
	with Ferrule / Lug	0.2 - 4.0 mm ²
With 2 same size Conductors per clamp	with TWIN Ferrule / Lug	0.5 - 1.0 mm ²
Wire Stripping Length	10 mm	
Ratings As Per	IEC60947-7-2	
Voltage		
Current		
Approval		
Insulation Material / Material Group	Polyamide 6,6 / 1	
Rated Impulse Voltage / Pollution Degree	8 KV / 3	

	Type / Cat. No.	Standard Pack
Terminal Block	CXSG2.5	50
End Plate	EPCXS2.5	50
Mounting Rail (Refer Pg. 263 for details)	CA701-1M / CA701-1M-S CA701-15-1M / CA701-15-1M-S	50 m 25 m
End Clamp (Refer Pg. 264 for details)	CA103 / CA104	50
Marking Tags (Refer Pg. 268 for details)	CA509/K5WHT	100
Marker Card (Refer Pg. 269 for details)	MC5	10
Screw Driver	SCM0.5/3 Blade size: 0.5 x 3 mm	10
Jumpers	Type / Cat. No.	Imax Standard Pack
Pluggable Jumpers	2 pole	JX2.5/2 24 A 100
	3 pole	JX2.5/3 24 A 50
	4 pole	JX2.5/4 24 A 50
	5 pole	JX2.5/5 24 A 50
	6 pole	JX2.5/6 24 A 10
	7 pole	JX2.5/7 24 A 10
	8 pole	JX2.5/8 24 A 10
	10 pole	JX2.5/10 24 A 10
	16 pole	JX2.5/16 24 A 10
	20 pole	JX2.5/20 24 A 10
Test Plug	TX2.5	20

	Type / Cat. No.	Standard Pack	
Terminal Block	CXSG4	50	
End Plate	EPCXS2.5	50	
Mounting Rail (Refer Pg. 263 for details)	CA701-1M / CA701-1M-S CA701-15-1M / CA701-15-1M-S	50 m 25 m	
End Clamp (Refer Pg. 264 for details)	CA103 / CA104	50	
Marking Tags (Refer Pg. 268 for details)	CA509/K6WHT	100	
Marker Card (Refer Pg. 269 for details)	MC6	10	
Screw Driver	SCM0.5/3 Blade size: 0.5 x 3 mm	10	
Jumpers	Type / Cat. No.	Imax Standard Pack	
Pluggable Jumpers	2 pole	JX4/2 32 A 100	
	3 pole	JX4/3 32 A 50	
	4 pole	JX4/4 32 A 50	
	5 pole	JX4/5 32 A 50	
	6 pole	JX4/6 32 A 50	
	8 pole	JX4/8 32 A 10	
	10 pole	JX4/10 32 A 10	
	16 pole	JX4/16 32 A 10	
	Test Plug		

	Type / Cat. No.	Standard Pack	
Terminal Block	CXSG4	50	
End Plate	EPCXS2.5	50	
Mounting Rail (Refer Pg. 263 for details)	CA701-1M / CA701-1M-S CA701-15-1M / CA701-15-1M-S	50 m 25 m	
End Clamp (Refer Pg. 264 for details)	CA103 / CA104	50	
Marking Tags (Refer Pg. 268 for details)	CA509/K6WHT	100	
Marker Card (Refer Pg. 269 for details)	MC6	10	
Screw Driver	SCM0.5/3 Blade size: 0.5 x 3 mm	10	
Jumpers	Type / Cat. No.	Imax Standard Pack	
Pluggable Jumpers	2 pole	JX4/2 32 A 100	
	3 pole	JX4/3 32 A 50	
	4 pole	JX4/4 32 A 50	
	5 pole	JX4/5 32 A 50	
	6 pole	JX4/6 32 A 50	
	8 pole	JX4/8 32 A 10	
	10 pole	JX4/10 32 A 10	
	16 pole	JX4/16 32 A 10	
	Test Plug		

CXSG6

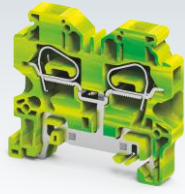

8 x 55.4 mm

49.8 mm / 57.3 mm

IEC	UL - CSA
0.2 - 6.0 mm ²	24 - 8 AWG
0.2 - 6.0 mm ²	24 - 8 AWG
0.5 - 1.5 mm ²	20 - 16 AWG
14 mm	
IEC60947-7-2	



Polyamide 6,6 / 1

8 KV / 3

CXSG10



10 x 65.3 mm

53.8 mm / 61.3 mm

IEC	UL - CSA
0.2 - 10.0 mm ²	24 - 6 AWG
0.2 - 10.0 mm ²	24 - 6 AWG
0.5 - 2.5 mm ²	20 - 14 AWG
18 mm	
IEC60947-7-2	



Polyamide 6,6 / 1

8 KV / 3

Type / Cat. No.	Standard Pack
CXSG6	50
EPCXS6	50
CA701-1M / CA701-1M-S	50 m
CA701-15-1M / CA701-15-1M-S	25 m
CA103 / CA104	50
CA509/K8WHT	100
MC8	10
SCM0.8/4 Blade size: 0.8 x 4 mm	10

Type / Cat. No.	I _{max}	Standard Pack
JX6/2	41 A	100
JX6/3	41 A	50
JX6/4	41 A	50
JX6/5	41 A	50
JX6/10	41 A	10

Type / Cat. No.	Standard Pack
CXSG10	50
EPCXS10	50
CA701-1M / CA701-1M-S	50 m
CA701-15-1M / CA701-15-1M-S	25 m
CA103 / CA104	50
CA509/K10WHT	100
MC10	10
SCM0.8/4 Blade size: 0.8 x 4 mm	10

Type / Cat. No.	I _{max}	Standard Pack
JX10/2	57 A	20

COMPACT HYBRID DISTRIBUTION TERMINAL BLOCK

CXDB35/10 is a compact Distribution Terminal Block. It is designed to suit standard Miniature Circuit Breaker (MCB) distribution boxes.

The terminal block is capable of accepting 35 mm² cables at the input side and 4 wires of 10 mm² can be connected at the output side.

The input cable is connected with a standard screw clamp system and the output wires can be connected with quick and reliable Spring clamp connections.

CXDB35/10 is a modular system and standard JX series jumpers can be used to add more connection points.

For distribution applications please note that the total system current should not exceed the allowed 125 A criteria.

The terminals with  & IECEx approval can be used in potentially explosive atmosphere. For detailed information refer page 289.

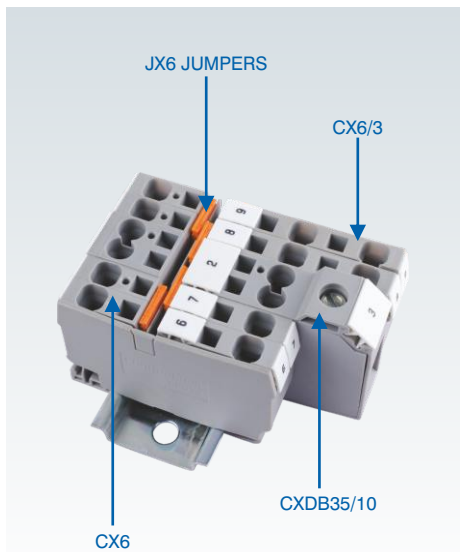

CXDB35/10

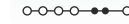
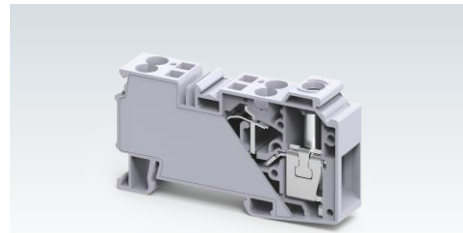

Width (Thickness) x Length		16 X 81.6 mm
Height with DIN 35 x 7.5 / 35 x 15 Rail		46.8 mm / 54.3 mm
Connection Possibility at Input as per		
With 1 Conductor per clamp	Stranded / Flexible with Ferrule / Lug	1.5 - 35.0 mm ² 1.5 - 35.0 mm ²
With 2 same size Conductors per clamp	Stranded / Flexible with TWIN Ferrule / Lug	4.0 - 16.0 mm ² 2.5 - 10.0 mm ²
Wire Stripping Length		17 mm

IEC		UL - CSA
1.5 - 35.0 mm ²		14 - 2 AWG
1.5 - 35.0 mm ²		14 - 2 AWG
4.0 - 16.0 mm ²		12 - 4 AWG
2.5 - 10.0 mm ²		14 - 8 AWG
Wire Stripping Length		17 mm

Connection Possibility at Output as per		IEC	UL - CSA
With 1 Conductor per clamp	Stranded / Flexible with Ferrule / Lug	0.2 - 10.0 mm ²	24 - 8 AWG
With 2 same size Conductors per clamp	with TWIN Ferrule / Lug	0.2 - 10.0 mm ²	24 - 8 AWG
With 2 same size Conductors per clamp	with TWIN Ferrule / Lug	0.5 - 2.5 mm ²	20 - 14 AWG
Wire Stripping Length		15 mm	





IEC		UL - CSA
0.2 - 10.0 mm ²		24 - 8 AWG
0.2 - 10.0 mm ²		24 - 8 AWG
0.5 - 2.5 mm ²		20 - 14 AWG
Wire Stripping Length		15 mm

Ratings at Input As Per		
Voltage	1000 V	600 V
Current	125 A	115 A
Torque	2.5 Nm	25 lb-in
Ratings at Output As Per		
Voltage	1000 V	600 V
Current	41 A	41 A

IEC60947-7-1	UL-1059	CSA22.2-158
1000 V	600 V	600 V
125 A	115 A	115 A
2.5 Nm	25 lb-in	25 lb-in
IEC60947-7-1	UL-1059	CSA22.2-158
1000 V	600 V	600 V
41 A	41 A	41 A

Approvals	
Insulation Material / Material Group	Polyamide 6,6 / 1
Rated Impulse Voltage / Pollution Degree	8 KV / 3

IEC	CE	UL	CSA	Ex	IECEx	AEx	CCC	
Polyamide 6,6 / 1								
8 KV / 3								

Terminal Block	With Slotted Screw With Allen Screw	
Mounting Rail	(Refer Pg. 263 for details)	
End Clamp	(Refer Pg. 264 for details)	
Marking Tags	(Refer Pg. 268 for details)	
Marker Card	(Refer Pg. 269 for details)	
Screw Driver	Screw Clamp Spring Clamp	

Type / Cat. No.	Standard Pack
CXDB35/10	20
CXDB35/10A	20
CA701-1M / CA701-1M-S	50 m
CA701-15-1M / CA701-15-1M-S	25 m
CA702 / CA802 / CA202	50
CA509/K16WHT	100
MC16	10
SCM1/5.5	Blade size: 1.0 x 5.5 mm
SCM0.8/4	Blade size: 0.8 x 4 mm

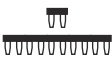
Jumpers	
Pluggable Jumpers	 2 pole 3 pole 4 pole 5 pole 10 pole
Step Down Jumpers	6 - 2.5 mm ² 6 - 4 mm ² 10 - 6 mm ²

Type / Cat. No.	Imax	Standard Pack
JX6/2	41 A	100
JX6/3	41 A	50
JX6/4	41 A	50
JX6/5	41 A	50
JX6/10	41 A	10
JXS6/2.5	24 A	50
JXS6/4	32 A	50
JXS10/6	41 A	50

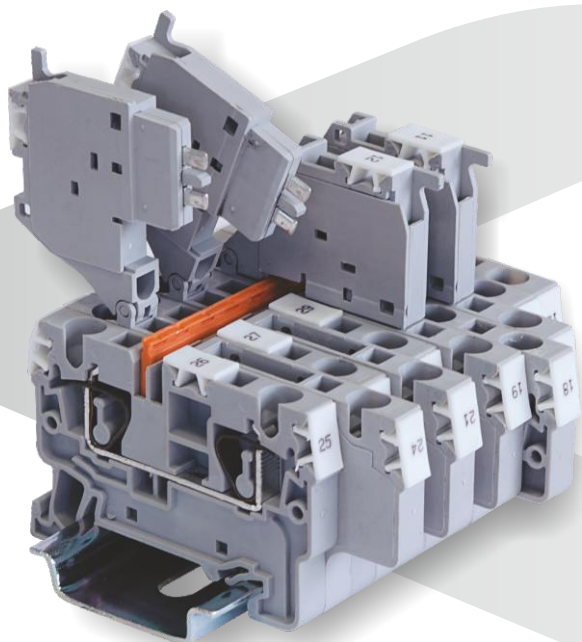
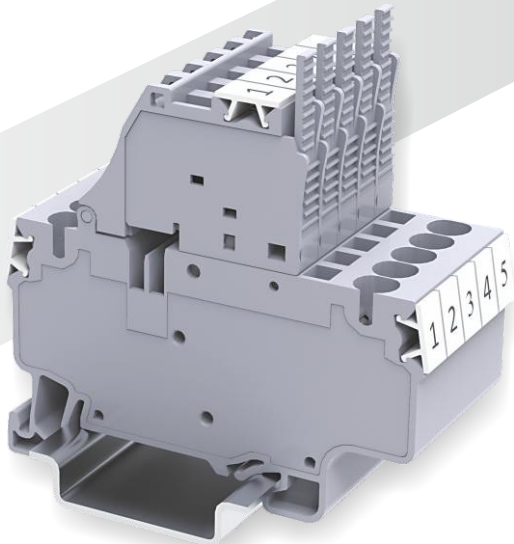
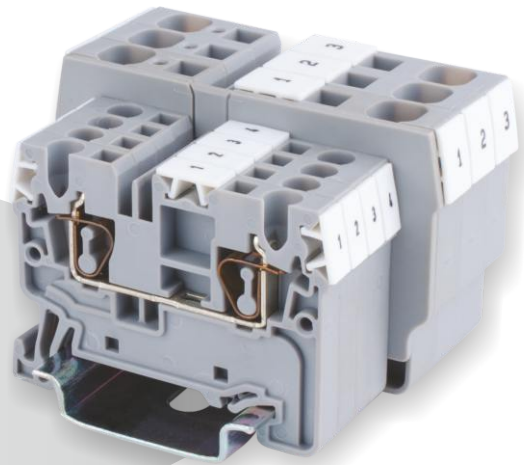

ANGULAR FEED THROUGH TERMINAL BLOCKS

These Terminal Blocks are an ideal choice for compact junction boxes having limitations of space and height. These terminals are also used for underfloor wiring systems.

A major advantage of Angular Terminal Blocks over the top wire entry Terminal Blocks is that their profile remains the same across the entire range of Feed Through, Multiple Connection, Ground and Ground Multiple Connection Terminal Blocks.

The other advantages include: Angular entry of wires saves conductor length, marking / identification facility on the center (top) of the block, Multiplication of connections through bridging.

Step Down Jumpers are used for shorting spring clamp Terminal Blocks of different sizes. For more details refer page 279.

The terminals with  & IECEx approval can be used in potentially explosive atmosphere. For detailed information refer page 289.

Width (Thickness) x Length	
Height with DIN 35 x 7.5 / 35 x 15 mm Rail	
Connection Possibility as per	
With 1 Conductor per clamp	Stranded / Flexible Solid with Ferrule / Lug
With 2 same size Conductors per clamp	with TWIN Ferrule / Lug
Wire Stripping Length	
Ratings As Per	
Voltage	
Current	
Approvals	
Insulation Material / Material Group	
Rated Impulse Voltage / Pollution Degree	

AS2.5



5 x 54 mm			
44.0 mm / 51.0 mm			
IEC		UL - CSA	
0.34 - 2.5 mm ²		22 - 12 AWG	
0.34 - 4.0 mm ²		22 - 10 AWG	
0.34 - 2.5 mm ²		22 - 12 AWG	
0.5 mm ²		20 AWG	
11 mm			
IEC60947-7-1 UL-1059 CSA22.2-158 IEC 60079-7			
800 V	600 V	600 V	630 V
24 A	25 A	25 A	21 A
Polyamide 6,6 / 1			
8 KV / 3			

Terminal Block	Grey Blue Red Yellow Black Green Ground / Earth
End Plate	
Mounting Rail (Refer Pg. 263 for details)	
End Clamp (Refer Pg. 264 for details)	
Marking Tags (Refer Pg. 268 for details)	
Marker Card (Refer Pg. 269 for details)	
Screw Driver	

Type / Cat. No.	Standard Pack
AS2.5	100
AS2.5BU	100
AS2.5R	100
AS2.5Y	100
AS2.5BK	100
AS2.5GN	100
AGT2.5 (Refer Pg. 85 for details)	100
EPAS2.5	50
CA701-1M / CA701-1M-S	50 m
CA701-15-1M / CA701-15-1M-S	25 m
CA103 / CA104	50
CA509/K5WHT	100
MC5	10
SCM0.5/3 Blade size: 0.5 x 3.0 mm	10

Jumpers	
Adjacent Jumper	
Alternate Jumper	
Insulated wire type pluggable jumpers	
Step Down Jumpers	

Type / Cat. No.	I _{max}	Standard Pack
CA801/1	24 A	100
CA801/1-3	24 A	100
CA901/1	17.5 A	100
CA901/5	32 A	100
CA901/6	32 A	100

AS4

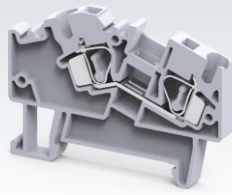

6 x 61.5 mm
44.0 mm / 51.0 mm

IEC	UL - CSA
0.2 - 4.0 mm ²	22 - 10 AWG
0.2 - 6.0 mm ²	
0.2 - 4.0 mm ²	22 - 10 AWG
0.5 - 1.0 mm ²	20 - 18 AWG

15 mm

IEC60947-7-1 UL-1059 CSA22.2-158 IEC 60079-7

800 V	600 V	600 V	630 V
32 A	35 A	35 A	28 A



Polyamide 6,6 / 1

8 KV / 3

AS6



8 x 74 mm
49.3 mm / 57.0 mm

IEC	UL - CSA
0.2 - 6.0 mm ²	22 - 8 AWG
0.2 - 6.0 mm ²	
0.2 - 6.0 mm ²	22 - 8 AWG
0.5 - 2.5 mm ²	20 - 14 AWG

15 mm

IEC60947-7-1 UL-1059 CSA22.2-158 IEC 60079-7

800 V	600 V	600 V	630 V
41 A	50 A	50 A	36 A



Polyamide 6,6 / 1

8 KV / 3

AS2.5/3

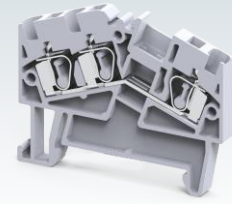

5 x 54 mm
44.0 mm / 51.0 mm

IEC	UL - CSA
0.34 - 2.5 mm ²	22 - 12 AWG
0.34 - 4.0 mm ²	22 - 10 AWG
0.34 - 2.5 mm ²	22 - 12 AWG
0.5 mm ²	20 AWG

11 mm

IEC60947-7-1 UL-1059 CSA22.2-158 IEC 60079-7

800 V	600 V	600 V	630 V
24 A	25 A	25 A	21 A



Polyamide 6,6 / 1

8 KV / 3

Type / Cat. No.	Standard Pack
AS4	100
AS4BU	100
AS4R	100
AS4Y	100
AS4BK	100
AS4GN	100
AGT4 (Refer Pg. 86 for details)	100
EPAS4	50
CA701-1M / CA701-1M-S	50 m
CA701-15-1M / CA701-15-1M-S	25 m
CA103 / CA104	50
CA509/K6WHT	100
MC6	10
SCM0.6/3.5 Blade size: 0.6 x 3.5 mm	10

Type / Cat. No.	Standard Pack
AS6	50
AS6BU	50
AS6R	50
AS6Y	50
AS6BK	50
AS6GN	50
AGT6 (Refer Pg. 86 for details)	50
EPAS6	50
CA701-1M / CA701-1M-S	50 m
CA701-15-1M / CA701-15-1M-S	25 m
CA103 / CA104	50
CA509/K8WHT	100
MC8	10
SCM0.8/4 Blade size: 0.8 x 4 mm	10

Type / Cat. No.	Standard Pack
AS2.5/3	100
AS2.5/3BU	100
AS2.5/3R	100
AS2.5/3Y	100
AS2.5/3BK	100
AS2.5/3GN	100
AGT2.5/3 (Refer Pg. 86 for details)	100
EPAS2.5	50
CA701-1M / CA701-1M-S	50 m
CA701-15-1M / CA701-15-1M-S	25 m
CA103 / CA104	50
CA509/K5WHT	100
MC5	10
SCM0.5/3 Blade size: 0.5 x 3 mm	10

Type / Cat. No.	I _{max}	Standard Pack
CA801/2	20 A	100
CA801/2-3	20 A	100
CA901/2	17.5 A	100
CA901/4	20 A	100
CA901/6	32 A	100

Type / Cat. No.	I _{max}	Standard Pack
CA801/3	35 A	100
CA801/3-3	30 A	100
CA901/3	30 A	100
CA901/4	30 A	100
CA901/5	32 A	100
CA801/8	41 A	100

Type / Cat. No.	I _{max}	Standard Pack
CA801/1	24 A	100
CA801/1-3	24 A	100
CA901/1	17.5 A	100
CA901/5	32 A	100
CA901/6	32 A	100



ANGULAR FEED THROUGH TERMINAL BLOCKS

AS2.5/4



AS4/3



Width (Thickness) x Length		5 x 54 mm	
Height with DIN 35 x 7.5 / 35 x 15 mm Rail		44.0 mm / 51.0 mm	
Connection Possibility as per		IEC	UL - CSA
With 1 Conductor per clamp	Stranded / Flexible	0.34 - 2.5 mm ²	22 - 12 AWG
	Solid	0.34 - 4.0 mm ²	22 - 10 AWG
	with Ferrule / Lug	0.34 - 2.5 mm ²	22 - 12 AWG
With 2 same size Conductors per clamp	with TWIN Ferrule / Lug	0.5 mm ²	20 AWG
Wire Stripping Length		11 mm	
Ratings As Per		IEC60947-7-1	UL-1059 CSA22.2-158 IEC 60079-7
Voltage		800 V	600 V 600 V 630 V
Current		24 A	25 A 25 A 21 A
Approvals			
Insulation Material / Material Group		Polyamide 6,6 / 1	
Rated Impulse Voltage / Pollution Degree		8 KV / 3	

Width (Thickness) x Length		6 x 61.5 mm	
Height with DIN 35 x 7.5 / 35 x 15 mm Rail		44.0 mm / 51.0 mm	
Connection Possibility as per		IEC	UL - CSA
With 1 Conductor per clamp	Stranded / Flexible	0.2 - 4.0 mm ²	22 - 10 AWG
	Solid	0.2 - 6.0 mm ²	22 - 10 AWG
	with Ferrule / Lug	0.2 - 4.0 mm ²	22 - 10 AWG
With 2 same size Conductors per clamp	with TWIN Ferrule / Lug	0.5 - 1.0 mm ²	20 - 10 AWG
Wire Stripping Length		15 mm	
Ratings As Per		IEC60947-7-1	UL-1059 CSA22.2-158 IEC 60079-7
Voltage		800 V	600 V 600 V 630 V
Current		32 A	35 A 35 A 28 A
Approvals			
Insulation Material / Material Group		Polyamide 6,6 / 1	
Rated Impulse Voltage / Pollution Degree		8 KV / 3	

		Type / Cat. No.	Standard Pack
Terminal Block	Grey	AS2.5/4	100
	Blue	AS2.5/4BU	100
	Red	AS2.5/4R	100
	Yellow	AS2.5/4Y	100
	Black	AS2.5/4BK	100
	Green	AS2.5/4GN	100
	Ground / Earth	AGT2.5/4 (Refer Pg. 87 for details)	100
End Plate		EPAS2.5	50
Mounting Rail (Refer Pg. 263 for details)		CA701-1M / CA701-1M-S	50 m
		CA701-15-1M / CA701-15-1M-S	25 m
End Clamp (Refer Pg. 264 for details)		CA103 / CA104	50
Marking Tags (Refer Pg. 268 for details)		CA509/K5WHT	100
Marker Card (Refer Pg. 269 for details)		MC5	10
Screw Driver		SCM0.5/3 Blade size: 0.5 x 3 mm	10

		Type / Cat. No.	Standard Pack
Terminal Block	Grey	AS4/3	100
	Blue	AS4/3BU	100
	Red	AS4/3R	100
	Yellow	AS4/3Y	100
	Black	AS4/3BK	100
	Green	AS4/3GN	100
	Ground / Earth	AGT4/3 (Refer Pg. 87 for details)	100
End Plate		EPAS4	50
Mounting Rail (Refer Pg. 263 for details)		CA701-1M / CA701-1M-S	50 m
		CA701-15-1M / CA701-15-1M-S	25 m
End Clamp (Refer Pg. 264 for details)		CA103 / CA104	50
Marking Tags (Refer Pg. 268 for details)		CA509/K6WHT	100
Marker Card (Refer Pg. 269 for details)		MC6	10
Screw Driver		SCM0.6/3.5 Blade size: 0.6 x 3.5 mm	10

		Type / Cat. No.	Imax	Standard Pack
Adjacent Jumper				
Alternate Jumper				
Insulated wire type pluggable jumpers				
Step Down Jumpers				

		Type / Cat. No.	Imax	Standard Pack
Adjacent Jumper		CA801/2	20 A	100
Alternate Jumper		CA801/2-3	20 A	100
Insulated wire type pluggable jumpers		CA901/2	17.5 A	100
Step Down Jumpers		CA901/4	20 A	100
		CA901/6	32 A	100

		Type / Cat. No.	Imax	Standard Pack
Adjacent Jumper		CA801/2	20 A	100
Alternate Jumper		CA801/2-3	20 A	100
Insulated wire type pluggable jumpers		CA901/2	17.5 A	100
Step Down Jumpers		CA901/4	20 A	100
		CA901/6	32 A	100

		Type / Cat. No.	Imax	Standard Pack
Adjacent Jumper		CA801/2	20 A	100
Alternate Jumper		CA801/2-3	20 A	100
Insulated wire type pluggable jumpers		CA901/2	17.5 A	100
Step Down Jumpers		CA901/4	20 A	100
		CA901/6	32 A	100

AS4/4



6 x 61.5 mm

44.0 mm / 51.0 mm

IEC	UL - CSA
0.2 - 4.0 mm ²	22 - 10 AWG
0.2 - 6.0 mm ²	
0.2 - 4.0 mm ²	22 - 10 AWG
0.5 - 1.0 mm ²	20 - 18 AWG

15 mm

IEC60947-7-1 UL-1059 CSA22.2-158 IEC 60079-7

800 V	600 V	600 V	630 V
32 A	35 A	35 A	28 A



Polyamide 6,6 / 1

8 KV / 3

AS6/3

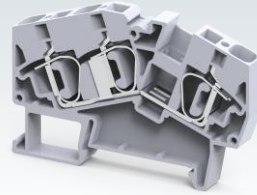

8 x 74 mm

49.3 mm / 57.0 mm

IEC	UL - CSA
0.2 - 6.0 mm ²	22 - 8 AWG
0.2 - 6.0 mm ²	
0.2 - 6.0 mm ²	22 - 8 AWG
0.5 - 2.5 mm ²	20 - 14 AWG

15 mm

IEC60947-7-1 UL-1059 CSA22.2-158 IEC 60079-7

800 V	600 V	600 V	630 V
41 A	50 A	50 A	36 A



Polyamide 6,6 / 1

8 KV / 3

Type / Cat. No.	Standard Pack
AS4/4	50
AS4/4BU	50
AS4/4R	50
AS4/4Y	50
AS4/4BK	50
AS4/4GN	50
AGT4/4 (Refer Pg. 88 for details)	50
EPAS4	50
CA701-1M / CA701-1M-S	50 m
CA701-15-1M / CA701-15-1M-S	25 m
CA103 / CA104	50
CA509/K6WHT	100
MC6	10
SCM0.6/3.5 Blade size: 0.6 x 3.5 mm	10

Type / Cat. No.	I _{max}	Standard Pack

Type / Cat. No.	Standard Pack
AS6/3	50
AS6/3BU	50
AS6/3R	50
AS6/3Y	50
AS6/3BK	50
AS6/3GN	50
AGT6/3 (Refer Pg. 88 for details)	50
EPAS6	50
CA701-1M / CA701-1M-S	50 m
CA701-15-1M / CA701-15-1M-S	25 m
CA103 / CA104	50
CA509/K8WHT	100
MC8	10
SCM0.8/4 Blade size: 0.8 x 4 mm	10

Type / Cat. No.	I _{max}	Standard Pack
CA801/3	35 A	100
CA801/3-3	30 A	100
CA901/3	30 A	100
CA901/4	30 A	100
CA901/5	32 A	100
CA801/8	41 A	100

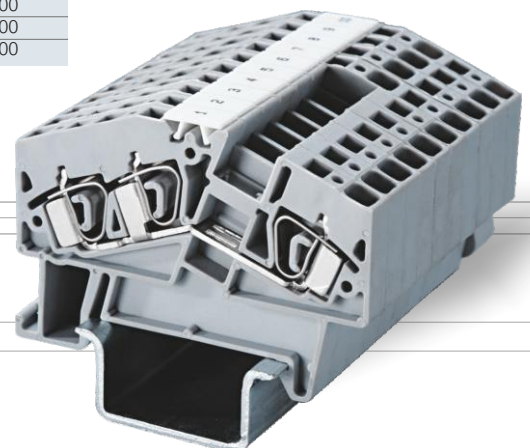

ANGULAR GROUND / EARTH TERMINAL BLOCKS





Besides having angular wire entry, these Terminal Blocks have specially designed alloy feet which help in achieving very low contact resistance and vibration proof grounding with the DIN rails. They are Green-Yellow colour coded as per industry standards.

The terminals with  & IECEx approval can be used in potentially explosive atmosphere. For detailed information refer page 289.

Width (Thickness) x Length	5 x 54 mm	
Height with DIN 35 x 7.5 / 35 x 15 mm Rail	44.0 mm / 51.6 mm	
Connection Possibility as per	IEC	UL - CSA
With 1 Conductor per clamp	Stranded / Flexible	22 - 12 AWG
	Solid	22 - 10 AWG
	with Ferrule / Lug	22 - 12 AWG
With 2 same size Conductors per clamp	with TWIN Ferrule / Lug	20 AWG
Wire Stripping Length	11 mm	
Ratings As Per	IEC60947-7-2	
Approvals		
Insulation Material / Material Group	Polyamide 6,6 / 1	
Rated Impulse Voltage / Pollution Degree	8 KV / 3	

AGT2.5



		Type / Cat. No.	Standard Pack
Terminal Block		AGT2.5	100
End Plate		EPAS2.5	50
Mounting Rail	(Refer Pg. 263 for details) 	CA701-1M / CA701-1M-S	50 m
Marking Tags	(Refer Pg. 268 for details) 	CA701-15-1M / CA701-15-1M-S	25 m
Marker Card	(Refer Pg. 269 for details)	CA509/K5WHT	100
Marker Card		MC5	10
Screw Driver		SCM0.5/3	Blade size: 0.5 x 3 mm / 10

AGT4



6 x 61.5 mm
44.0 mm / 51.6 mm

IEC	UL - CSA
0.2 - 4.0 mm ²	22 - 10 AWG
0.2 - 6.0 mm ²	
0.2 - 4.0 mm ²	22 - 10 AWG
0.5 - 1.0 mm ²	20 - 18 AWG

15 mm
IEC60947-7-2



Polyamide 6,6 / 1
8 KV / 3

AGT6



8 x 74 mm
49.3 mm / 57.0 mm

IEC	UL - CSA
0.2 - 6.0 mm ²	22 - 8 AWG
0.2 - 6.0 mm ²	22 - 8 AWG
0.5 - 2.5 mm ²	20 - 14 AWG

15 mm
IEC60947-7-2



Polyamide 6,6 / 1
8 KV / 3

AGT2.5/3

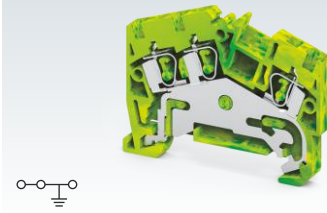

5 x 54 mm
44.0 mm / 51.6 mm

IEC	UL - CSA
0.34 - 2.5 mm ²	22 - 12 AWG
0.34 - 4.0 mm ²	22 - 10 AWG
0.34 - 2.5 mm ²	22 - 12 AWG
0.5 mm ²	20 AWG

11 mm
IEC60947-7-2



Polyamide 6,6 / 1
8 KV / 3

Type / Cat. No.	Standard Pack
AGT4	100
EPAS4	50
CA701-1M / CA701-1M-S	50 m
CA701-15-1M / CA701-15-1M-S	25 m
CA509/K6WHT	100
MC6	10
SCM0.6/3.5 Blade size: 0.6 x 3.5 mm	10

Type / Cat. No.	Standard Pack
AGT6	50
EPAS6	50
CA701-1M / CA701-1M-S	50 m
CA701-15-1M / CA701-15-1M-S	25 m
CA509/K8WHT	100
MC8	10
SCM0.8/4 Blade size: 0.8 x 4 mm	10

Type / Cat. No.	Standard Pack
AGT2.5/3	100
EPAS2.5	50
CA701-1M / CA701-1M-S	50 m
CA701-15-1M / CA701-15-1M-S	25 m
CA509/K5WHT	100
MC5	10
SCM0.5/3 Blade size: 0.5 x 3 mm	10

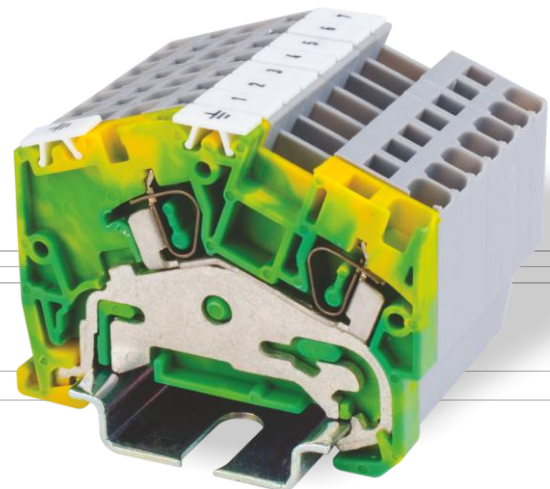

ANGULAR GROUND / EARTH TERMINAL BLOCKS

AGT2.5/4



AGT4/3

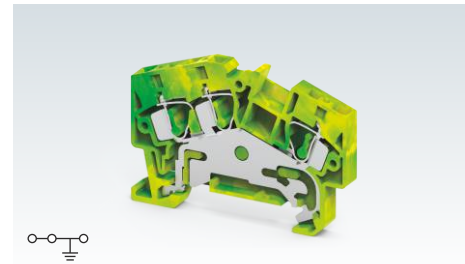

Width (Thickness) x Length	5 x 54 mm		6 x 61.5 mm	
Height with DIN 35 x 7.5 / 35 x 15 mm Rail	44.0 mm / 51.6 mm		44.0 mm / 51.6 mm	
Connection Possibility as per	IEC	UL - CSA	IEC	UL - CSA
With 1 Conductor per clamp	Stranded / Flexible	0.34 - 2.5 mm ²	22 - 12 AWG	0.2 - 4.0 mm ²
	Solid	0.34 - 4.0 mm ²	22 - 10 AWG	0.2 - 6.0 mm ²
	with Ferrule / Lug	0.34 - 2.5 mm ²	22 - 12 AWG	0.2 - 4.0 mm ²
With 2 same size Conductors per clamp	with TWIN Ferrule / Lug	0.5 mm ²	20 AWG	0.5 - 1.0 mm ²
Wire Stripping Length	11 mm		15 mm	
Ratings As Per	IEC60947-7-2		IEC60947-7-2	
Approvals				
Insulation Material / Material Group	Polyamide 6,6 / 1		Polyamide 6,6 / 1	
Rated Impulse Voltage / Pollution Degree	8 KV / 3		8 KV / 3	

	Type / Cat. No.	Standard Pack	Type / Cat. No.	Standard Pack
Terminal Block	AGT2.5/4	100	AGT4/3	100
End Plate	EPAS2.5	50	EPAS4	50
Mounting Rail (Refer Pg. 263 for details)	CA701-1M / CA701-1M-S	50 m	CA701-1M / CA701-1M-S	50 m
	CA701-15-1M / CA701-15-1M-S	25 m	CA701-15-1M / CA701-15-1M-S	25 m
Marking Tags (Refer Pg. 268 for details)	CA509/K5WHT	100	CA509/K6WHT	100
Marker Card (Refer Pg. 269 for details)	MC5	10	MC6	10
Screw Driver	SCM0.5/3	Blade size: 0.5 x 3 mm	SCM0.6/3.5	Blade size: 0.6 x 3.5 mm

AGT4/4



6 x 61.5 mm
44.0 mm / 51.6 mm

IEC	UL - CSA
0.2 - 4.0 mm ²	22 - 10 AWG
0.2 - 6.0 mm ²	
0.2 - 4.0 mm ²	22 - 10 AWG
0.5 - 1.0 mm ²	20 - 18 AWG

15 mm

IEC60947-7-2



Polyamide 6,6 / 1

8 KV / 3

AGT6/3



8 x 74 mm
49.3 mm / 57.0 mm

IEC	UL - CSA
0.2 - 6.0 mm ²	22 - 8 AWG
0.2 - 6.0 mm ²	
0.2 - 6.0 mm ²	22 - 8 AWG
0.5 - 2.5 mm ²	20 - 14 AWG

15 mm

IEC60947-7-2



Polyamide 6,6 / 1

8 KV / 3

Type / Cat. No.	Standard Pack
AGT4/4	100
EPAS4	50
CA701-1M / CA701-1M-S	50 m
CA701-15-1M / CA701-15-1M-S	25 m
CA509/K6WHT	100
MC6	10
SCM0.6/3.5 Blade size: 0.6 x 3.5 mm	10

Type / Cat. No.	Standard Pack
AGT6/3	50
EPAS6	50
CA701-1M / CA701-1M-S	50 m
CA701-15-1M / CA701-15-1M-S	25 m
CA509/K8WHT	100
MC8	10
SCM0.8/4 Blade size: 0.8 x 4 mm	10

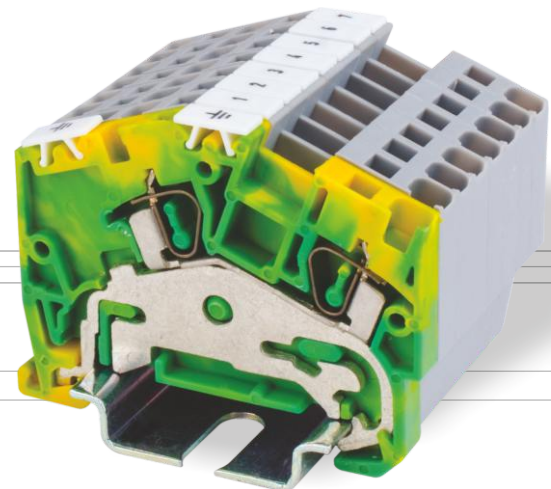

PANEL MOUNT TERMINAL BLOCKS





CM series Terminal Blocks have a side wire entry configuration. These blocks are an excellent solution for extremely compact wiring applications. The Terminal Blocks are "modular" and can be stacked to form multipole assemblies. The stacked assemblies can be mounted on the panel surface using an End Plate at one end only.

These Terminal Blocks are perfect solution for industries like Control Transformer, Elevators, Junction Boxes and applications with limited wiring space.

CSCP2.5T & CSCP2.5T2 Terminal Blocks have top wire entry. Jumpers can be easily inserted by using Spring Clamp Actuator tool SCA2.5.



The CXCP2.5/4 Terminal Block has the same profile as the CSCP2.5T terminals and can be stacked together with them. The CXCP2.5/4 terminals can be mounted on standard DIN Rails.

The terminals with  & IECEx approval can be used in potentially explosive atmosphere. For detailed information refer page 289.

Width (Thickness) x Length		5 x 26.5 mm			
Height		18 mm (Panel Mount)			
Connection Possibility as per		IEC		UL - CSA	
With 1 Conductor per clamp	Stranded / Flexible	0.2 - 1.5 mm ²		24 - 16 AWG	
	Solid with Ferrule / Lug	0.2 - 2.5 mm ²		24 - 18 AWG	
With 2 same size Conductors per clamp	with TWIN Ferrule / Lug	0.2 - 1.5 mm ²		24 - 18 AWG	
		0.5 mm ²		20 AWG	
Wire Stripping Length		8 mm			
Ratings As Per		IEC60947-7-1	UL-1059	CSA22.2-158	IEC60079-7
Voltage		500 V	300 V	300 V	320 V
Current		17 A	10 A	10 A	15 A
Approvals					
Insulation Material / Material Group		Polyamide 6,6 / 1			
Rated Impulse Voltage / Pollution Degree		6 KV / 3			
		Type / Cat. No.		Standard Pack	
Terminal Block	Grey	CM1.5S		100	
	Blue	CM1.5SBU		100	
	Red	CM1.5SR		100	
	Yellow	CM1.5SY		100	
	Black	CM1.5SBK		100	
	Green	CM1.5SGN		100	
	Orange	CM1.5SO		100	
	Yellow-Green	CM1.5SYG		100	
End Plate		EPCM1.5S		50	
Marking Tags (Refer Pg. 268 for details)		CA509/K4WHT		100	
Marker Card (Refer Pg. 269 for details)					
Screw Driver		SCM0.5/3	Blade size: 0.5 x 3 mm		10
Panel Mount Screw Size		M3			



Width (Thickness) x Length		5 x 26.5 mm			
Height		18 mm (Panel Mount)			
Connection Possibility as per		IEC		UL - CSA	
With 1 Conductor per clamp	Stranded / Flexible	0.2 - 1.5 mm ²		24 - 16 AWG	
	Solid with Ferrule / Lug	0.2 - 2.5 mm ²		24 - 18 AWG	
With 2 same size Conductors per clamp	with TWIN Ferrule / Lug	0.2 - 1.5 mm ²		24 - 18 AWG	
		0.5 mm ²		20 AWG	
Wire Stripping Length		8 mm			
Ratings As Per		IEC60947-7-1	UL-1059	CSA22.2-158	IEC60079-7
Voltage		500 V	300 V	300 V	320 V
Current		17 A	10 A	10 A	15 A
Approvals					
Insulation Material / Material Group		Polyamide 6,6 / 1			
Rated Impulse Voltage / Pollution Degree		6 KV / 3			

		Type / Cat. No.		Standard Pack	
Terminal Block	Grey	CM1.5S		100	
	Blue	CM1.5SBU		100	
	Red	CM1.5SR		100	
	Yellow	CM1.5SY		100	
	Black	CM1.5SBK		100	
	Green	CM1.5SGN		100	
	Orange	CM1.5SO		100	
	Yellow-Green	CM1.5SYG		100	
End Plate		EPCM1.5S		50	
Marking Tags (Refer Pg. 268 for details)		CA509/K4WHT		100	
Marker Card (Refer Pg. 269 for details)					
Screw Driver		SCM0.5/3	Blade size: 0.5 x 3 mm		10
Panel Mount Screw Size		M3			

CM1.5S2

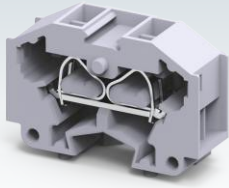

8 x 26.5 mm

18 mm (Panel Mount)

IEC	UL - CSA
0.2 - 1.5 mm ²	24 - 16 AWG
0.2 - 2.5 mm ²	
0.2 - 1.5 mm ²	24 - 18 AWG
0.5 mm ²	20 AWG

8 mm

IEC60947-7-1	UL-1059	CSA22.2-158	IEC60079-7
500 V	300 V	300 V	320 V
17 A	10 A	10 A	15 A



Polyamide 6,6 / 1

6 KV / 3

CM2.5S

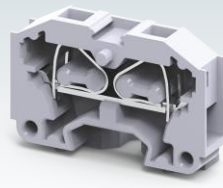

6 x 30 mm

20 mm (Panel Mount)

IEC	UL - CSA
0.34 - 2.5 mm ²	22 - 12 AWG
0.34 - 4.0 mm ²	
0.34 - 2.5 mm ²	22 - 12 AWG
0.5 - 1.0 mm ²	20 - 18 AWG

8 mm

IEC60947-7-1	UL-1059	CSA22.2-158	IEC60079-7
500 V	300 V	300 V	320 V
24 A	20 A	20 A	21 A



Polyamide 6,6 / 1

6 KV / 3

CM2.5S2

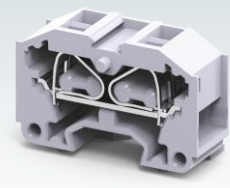

10 x 30 mm

20 mm (Panel Mount)

IEC	UL - CSA
0.34 - 2.5 mm ²	22 - 12 AWG
0.34 - 4.0 mm ²	
0.34 - 2.5 mm ²	22 - 12 AWG
0.5 - 1.0 mm ²	20 - 18 AWG

8 mm

IEC60947-7-1	UL-1059	CSA22.2-158	IEC60079-7
500 V	300 V	300 V	320 V
24 A	20 A	20 A	21 A



Polyamide 6,6 / 1

6 KV / 3

Type / Cat. No.	Standard Pack
CM1.5S2	100
CM1.5S2BU	100
CM1.5S2R	100
CM1.5S2Y	100
CM1.5S2BK	100
CM1.5S2GN	100
CM1.5S2O	100
CM1.5S2YG	100
EPCM1.5S	50
CA509/K7.5WHT	100
SCM0.5/3	10
M3	

Type / Cat. No.	Standard Pack
CM2.5S	100
CM2.5SBU	100
CM2.5SR	100
CM2.5SY	100
CM2.5SBK	100
CM2.5SGN	100
CM2.5SO	100
CM2.5SYG	100
EPCM2.5S	50
CA509/K2WHT	100
MC2	10
SCM0.5/3	10
M3	

Type / Cat. No.	Standard Pack
CM2.5S2	100
CM2.5S2BU	100
CM2.5S2R	100
CM2.5S2Y	100
CM2.5S2BK	100
CM2.5S2GN	100
CM2.5S2O	100
CM2.5S2YG	100
EPCM2.5S	50
CA509/K7.5WHT	100
SCM0.5/3	10
M3	

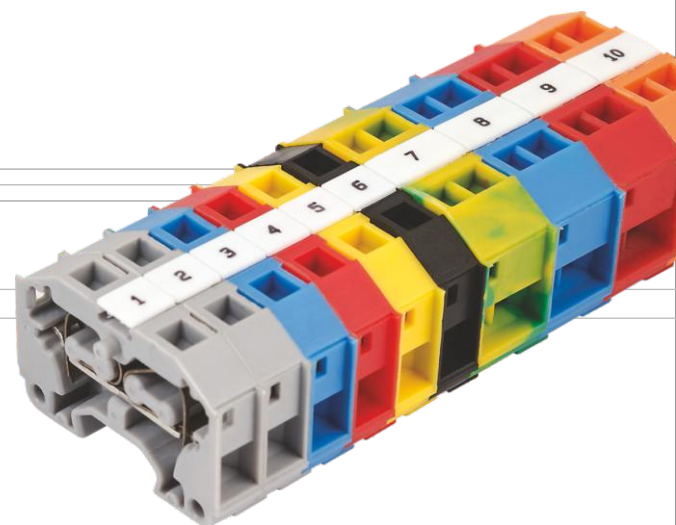

PANEL MOUNT TERMINAL BLOCKS

CM4S

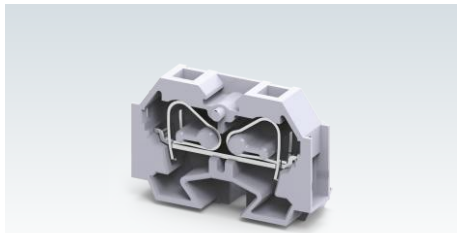

CM4S2

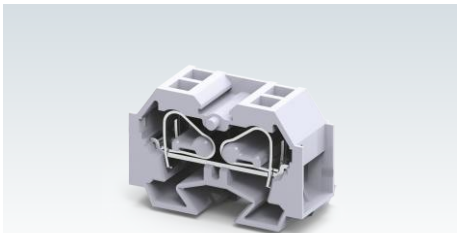

Width (Thickness) x Length	7 x 33.7 mm	
Height	23 mm (Panel Mount)	
Connection Possibility as per	IEC	UL - CSA
With 1 Conductor per clamp	Stranded / Flexible	0.2 - 4.0 mm ²
	Solid	0.2 - 6.0 mm ²
With 2 same size Conductors per clamp	with Ferrule / Lug	0.2 - 4.0 mm ²
	with TWIN Ferrule / Lug	0.5 - 1.0 mm ²
Wire Stripping Length	10 mm	
Ratings As Per	IEC60947-7-1	UL-1059 CSA22.2-158
Voltage	630 V	300 V
Current	32 A	26 A
Approvals		
Insulation Material / Comparative Tracking Index	Polyamide 66 / 1	
Rated Impulse Voltage / Pollution Degree	6 KV / 3	

Width (Thickness) x Length	12 x 33.7 mm	
Height	23 mm (Panel Mount)	
Connection Possibility as per	IEC	UL - CSA
With 1 Conductor per clamp	Stranded / Flexible	0.2 - 4.0 mm ²
	Solid	0.2 - 6.0 mm ²
With 2 same size Conductors per clamp	with Ferrule / Lug	0.2 - 4.0 mm ²
	with TWIN Ferrule / Lug	0.5 - 1.0 mm ²
Wire Stripping Length	10 mm	
Ratings As Per	IEC60947-7-1	UL-1059 CSA22.2-158
Voltage	630 V	300 V
Current	32 A	26 A
Approvals		
Insulation Material / Comparative Tracking Index	Polyamide 66 / 1	
Rated Impulse Voltage / Pollution Degree	6 KV / 3	

Terminal Block	Grey	CM4S	100
	Blue	CM4SBU	100
	Red	CM4SR	100
	Yellow	CM4SY	100
	Black	CM4SBK	100
	Green	CM4SGN	100
	Orange	CM4SO	100
	Yellow-Green	CM4SYG	100
End Plate		EPCM4S	50
Marking Tags (Refer Pg. 268 for details)		CA509/K6WHT	100
Marker Card (Refer Pg. 269 for details)		MC6	10
Screw Driver		SCM0.6/3.5 Blade size: 0.6 x 3.5 mm	10
External Jumper			
End Clamp (Refer Pg. 264 for details)			
Warning Label			
Mounting Rail (Refer Pg. 263 for details)			
Panel Mount Screw Size		M3	

Type / Cat. No.	Standard Pack
CM4S	100
CM4SBU	100
CM4SR	100
CM4SY	100
CM4SBK	100
CM4SGN	100
CM4SO	100
CM4SYG	100
EPCM4S	50
CA509/K6WHT	100
MC6	10
SCM0.6/3.5 Blade size: 0.6 x 3.5 mm	10
M3	

Type / Cat. No.	Standard Pack
CM4S2	100
CM4S2BU	100
CM4S2R	100
CM4S2Y	100
CM4S2BK	100
CM4S2GN	100
CM4S2O	100
CM4S2YG	100
EPCM4S	50
CA509/K12WHT	100
MC12	10
SCM0.6/3.5 Blade size: 0.6 x 3.5 mm	10
M3	

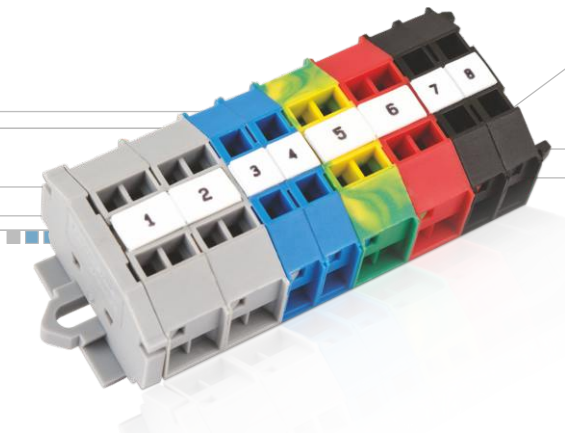

CSCP2.5T

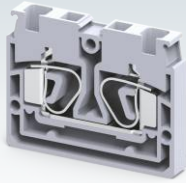

5 x 35 mm

27.3 (Panel Mount)

IEC	UL - CSA
0.2 - 2.5 mm ²	22 - 14 AWG
0.2 - 4.0 mm ²	22 - 12 AWG
0.2 - 2.5 mm ²	22 - 14 AWG

0.5 mm²

20 AWG

11 mm

IEC60947-7-1 UL-1059 CSA22.2-158 IEC 60079-7

800 V	600 V	600 V	500 V
24 A	20 A	20 A	21 A



Polyamide 6,6 / 1

8 KV / 3

CXCP2.5

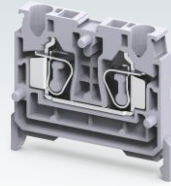

5 x 35 mm

27.3

IEC	UL - CSA
0.2 - 2.5 mm ²	22 - 14 AWG
0.2 - 4.0 mm ²	22 - 12 AWG
0.2 - 2.5 mm ²	22 - 14 AWG

0.5 mm²

20 AWG

11 mm

IEC60947-7-1 UL-1059 CSA22.2-158 IEC 60079-7

800 V	600 V	600 V	500 V
24 A	20 A	20 A	21 A



Polyamide 6,6 / 1

8 KV / 3

CSCP2.5T2

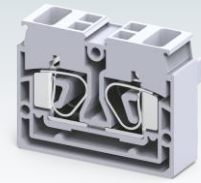

10 x 35 mm

27.3 (Panel Mount)

IEC	UL - CSA
0.2 - 2.5 mm ²	22 - 14 AWG
0.2 - 4.0 mm ²	22 - 12 AWG
0.2 - 2.5 mm ²	22 - 14 AWG

0.5 mm²

20 AWG

11 mm

IEC60947-7-1 UL-1059 CSA22.2-158 IEC 60079-7

800 V	600 V	600 V	500 V
24 A	20 A	20 A	21 A



Polyamide 6,6 / 1

8 KV / 3

Type / Cat. No.	Standard Pack
CSCP2.5T	100
CSCP2.5TBU	100
CSCP2.5TR	100
CSCP2.5TY	100
CSCP2.5TBK	100
CSCP2.5TGN	100
EPCSCP2.5T	50
CA509/K4WHT	100
SCM0.5/3 Blade size: 0.5 x 3 mm	10
CA803/1 I _{max.} : 24 A	100
CA701-1M / CA701-1M-S	50 m
CA701-15-1M / CA701-15-1M-S	25 m

Type / Cat. No.	Standard Pack
CXCP2.5	100
EPCSCP2.5T	50
CA509/K4WHT	100
SCM0.5/3 Blade size: 0.5 x 3 mm	10
CA803/1 I _{max.} : 24 A	100
CA701-1M / CA701-1M-S	50 m
CA701-15-1M / CA701-15-1M-S	25 m

Type / Cat. No.	Standard Pack
CSCP2.5T2	50
CSCP2.5T2BU	50
CSCP2.5T2R	50
CSCP2.5T2Y	50
CSCP2.5T2BK	50
CSCP2.5T2GN	50
EPCSCP2.5T	50
CA509/K3WHT	100
SCM0.5/3 Blade size: 0.5 x 3 mm	10
CA602	50
WLX2.5	100

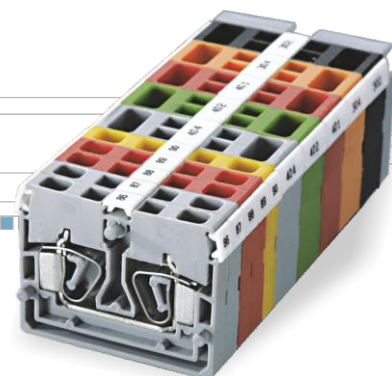

PANEL MOUNT TERMINAL BLOCKS

CXCP2.5/4

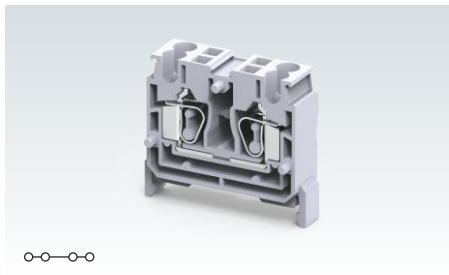

Width (Thickness) x Length	10 x 38 mm		
Height	36.5 mm / 44 mm		
Connection Possibility as per	IEC	UL - CSA	
With 1 Conductor per clamp	Stranded / Flexible	22 - 14 AWG	
	Solid	22 - 12 AWG	
	with Ferrule / Lug	22 - 14 AWG	
With 2 same size Conductors per clamp	with TWIN Ferrule / Lug	0.5 mm ²	20 AWG
Wire Stripping Length	10 mm		
Ratings As Per	IEC60947-7-1	UL-1059	CSA22.2-158
Voltage	1000 V	600 V	600 V
Current	24 A	20 A	20 A
Approvals	CE		
Insulation Material / Comparative Tracking Index	Polyamide 66 / 1		
Rated Impulse Voltage / Pollution Degree	8 KV / 3		

		Type / Cat. No.	Standard Pack
Terminal Block	Grey	CXCP2.5/4	50
	Blue		
	Red		
	Yellow		
	Black		
	Green		
	Orange		
Yellow-Green			
End Plate		EPCXCP2.5/4	50
Marking Tags (Refer Pg. 268 for details)		CA509/K3WHT	100
Marker Card (Refer Pg. 269 for details)			
Screw Driver		SCM0.5/3 Blade size: 0.5 x 3 mm	10
External Jumper			
End Clamp (Refer Pg. 264 for details)		CA103 / CA104	50
Mounting Rail (Refer Pg. 263 for details)		CA701-1M / CA701-1M-S	50 m
		CA701-15-1M / CA701-15-1M-S	25 m
Panel Mount Screw Size			

COMPONENT CARRIER TERMINAL BLOCKS

CXCC2.5/4, CXCC4, CXCC4/3 Spring Clamp Terminal Block are component carrier base. Various pluggable component carriers can be installed easily. These component carriers have built in protection against incorrect polarity.

Width (Thickness) x Length		5 x 74.7 mm
Height with DIN 35 x 7.5 / 35 x 15 mm Rail		37.6 mm / 45.2 mm
Connection Possibility as per		
With 1 Conductor per clamp	Stranded / Flexible	0.2 - 2.5 mm ²
	Solid with Ferrule / Lug	0.2 - 4.0 mm ²
With 2 same size Conductors per clamp	with TWIN Ferrule / Lug	0.2 - 2.5 mm ²
		0.5 mm ²
Wire Stripping Length		10 mm
Ratings As Per		IEC60947-7-1 UL-1059
Voltage		1000 V 600 V
Current		* *
Approval		
Insulation Material / Material Group		Polyamide 6,6 / 1
Rated Impulse Voltage / Pollution Degree		4 KV / 3

CXCC2.5/4

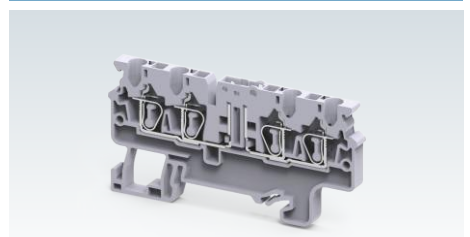

IEC		UL - CSA	
0.2 - 2.5 mm ²		24 - 12 AWG	
0.2 - 4.0 mm ²		24 - 10 AWG	
0.2 - 2.5 mm ²		24 - 12 AWG	
0.5 mm ²		20 AWG	
Wire Stripping Length			
10 mm			
Ratings As Per			
IEC60947-7-1 UL-1059			
Voltage		1000 V 600 V	
Current		* *	
Approval			
CE			
Insulation Material / Material Group			
Polyamide 6,6 / 1			
Rated Impulse Voltage / Pollution Degree			
4 KV / 3			

Current Rating applicable when used with plug CPD1, CPF & CIP

Terminal Block		
Mounting Rail	(Refer Pg. 263 for details)	
End Clamp	(Refer Pg. 264 for details)	
Shorting Link		2 pole
		3 pole
		4 pole
		5 pole
		6 pole
		7 pole
		8 pole
		10 pole
		20 pole
	Marking Tags	(Refer Pg. 268 for details)
Marker Card	(Refer Pg. 269 for details)	
Screw Driver		

Type / Cat. No.	Standard Pack
CXCC2.5/4	50
CA701-1M / CA701-1M-S	50 m
CA701-15-1M / CA701-15-1M-S	25 m
CA702	50
CA103	50
JX2.5/2	I _{max.} : 32 A 100
JX2.5/3	32 A 50
JX2.5/4	32 A 50
JX2.5/5	32 A 50
JX2.5/6	32 A 50
JX2.5/7	32 A 10
JX2.5/8	32 A 10
JX2.5/10	32 A 10
JX2.5/20	32 A 10
CA509/K5WHT	100
MC5	10
SCM0.5/3	Blade size: 0.5 x 3 mm 10

CC2.5 is component plug available in built in diode 1N4007 or Resistor.

CC2.5

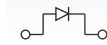
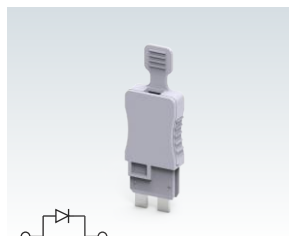

Component Carrier	Type / Cat. No.	Std. Pack
With Diode	CC2.5D	50
With 0.5 Ohm Resistor	CC2.5R0.5	50
With 1 Ohm Resistor	CC2.5R1	50
With 1.5 Ohm Resistor	CC2.5R1.5	50

Width (Thickness) x Length x Height	4.0 x 12.6 x 34.9 mm
* Current Rating	1 A

* Current Rating based on component carriers

CXCC4

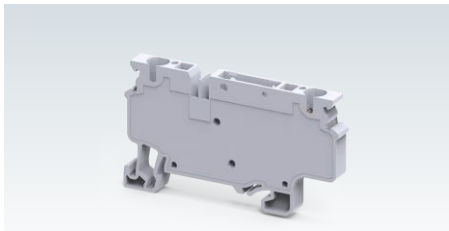

CXCC4/3

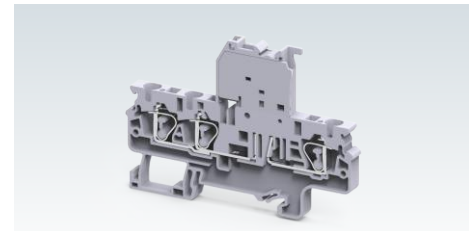

Width (Thickness) x Length		6 x 65.4 mm	
Height with DIN 35 x 7.5 / 35 x 15 mm Rail		38.2 mm / 45.8 mm	
Connection Possibility as per		IEC	UL - CSA
With 1 Conductor per clamp	Stranded / Flexible	0.2 - 4.0 mm ²	24 - 10 AWG
	Solid	0.2 - 6.0 mm ²	
	with Ferrule / Lug	0.2 - 4.0 mm ²	24 - 10 AWG
With 2 same size Conductors per clamp	with TWIN Ferrule / Lug	0.5 - 1.0 mm ²	20 - 18 AWG
Wire Stripping Length		10 mm	
Ratings As Per		IEC60947-7-1	UL-1059 CSA22.2-158 IEC60079-7
Voltage		1000 V	600 V 600 V 630 V
Current		*	* * * *
Approval			
Insulation Material / Material Group		Polyamide 6,6 / 1	
Rated Impulse Voltage / Pollution Degree		4 KV / 3	

Width (Thickness) x Length		6 x 65.4 mm	
Height with DIN 35 x 7.5 / 35 x 15 mm Rail		38.2 mm / 45.8 mm	
Connection Possibility as per		IEC	UL - CSA
With 1 Conductor per clamp	Stranded / Flexible	0.2 - 4.0 mm ²	24 - 10 AWG
	Solid	0.2 - 6.0 mm ²	
	with Ferrule / Lug	0.2 - 4.0 mm ²	24 - 10 AWG
With 2 same size Conductors per clamp	with TWIN Ferrule / Lug	0.5 - 1.0 mm ²	20 - 18 AWG
Wire Stripping Length		10 mm	
Ratings As Per		IEC60947-7-1	UL-1059 CSA22.2-158 IEC60079-7
Voltage		1000 V	600 V 600 V 630 V
Current		*	* * * *
Approval			
Insulation Material / Material Group		Polyamide 6,6 / 1	
Rated Impulse Voltage / Pollution Degree		4 KV / 3	

Width (Thickness) x Length		6 x 86.2 mm	
Height with DIN 35 x 7.5 / 35 x 15 mm Rail		38.2 mm / 45.8 mm	
Connection Possibility as per		IEC	UL - CSA
With 1 Conductor per clamp	Stranded / Flexible	0.2 - 4.0 mm ²	24 - 10 AWG
	Solid	0.2 - 6.0 mm ²	
	with Ferrule / Lug	0.2 - 4.0 mm ²	24 - 10 AWG
With 2 same size Conductors per clamp	with TWIN Ferrule / Lug	0.2 - 1.5 mm ²	24 - 14 AWG
Wire Stripping Length		10 mm	
Ratings As Per		IEC60947-7-1	UL-1059 CSA22.2-158 IEC60079-7
Voltage		1000 V	600 V 600 V 630 V
Current		*	* * * *
Approval			
Insulation Material / Material Group		Polyamide 6,6 / 1	
Rated Impulse Voltage / Pollution Degree		4 KV / 3	

Current Rating applicable when used with plug CPD1, CPF & CIP

Current Rating applicable when used with plug CPD1, CPF & CIP

Terminal Block		
Mounting Rail	(Refer Pg. 263 for details)	
End Clamp	(Refer Pg. 264 for details)	
Shorting Link		2 pole
		3 pole
		4 pole
		5 pole
		6 pole
		8 pole
		10 pole
16 pole		
Marking Tags	(Refer Pg. 268 for details)	
Marker Card	(Refer Pg. 269 for details)	
Screw Driver		

Type / Cat. No.	Standard Pack
CXCC4	50
CA701-1M / CA701-1M-S	50 m
CA701-15-1M / CA701-15-1M-S	25 m
CA702	50
CA103	50
JX4/2	I _{max} : 32 A 100
JX4/3	32 A 50
JX4/4	32 A 50
JX4/5	32 A 50
JX4/6	32 A 50
JX4/8	32 A 10
JX4/10	32 A 10
JX4/16	32 A 10
CA509/K6WHT	100
MC6	10
SCM0.6/3.5 Blade size: 0.6 x 3.5 mm	10

Type / Cat. No.	Standard Pack
CXCC4	50
CA701-1M / CA701-1M-S	50 m
CA701-15-1M / CA701-15-1M-S	25 m
CA702	50
CA103	50
JX4/2	I _{max} : 32 A 100
JX4/3	32 A 50
JX4/4	32 A 50
JX4/5	32 A 50
JX4/6	32 A 50
JX4/8	32 A 10
JX4/10	32 A 10
JX4/16	32 A 10
CA509/K6WHT	100
MC6	10
SCM0.6/3.5 Blade size: 0.6 x 3.5 mm	10

* Current Rating based on component carriers

CPD1 is component plug with built in diode 1N4007. CPF is component fuse plug suitable for Ø 5 x 20 mm fuses. CPFL is component plug which provides offline indication in case of a blown off fuse. CIP is a disconnecting plug which can be installed in the base Terminal Block CXCC4/3 and CXCC4/4.

CPD1

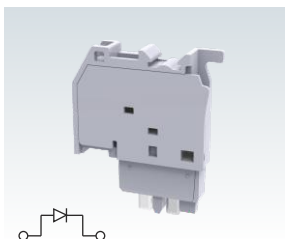

CPF

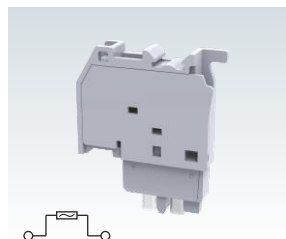

CIP



Component Carrier	With Diode	CPD1	50
	For Ø 5 x 20 mm Fuse	CPF	50
	Fuse with 6-60V AC/DC LED Circuit	CPFL6-60V	50
	Fuse with 110-240V AC/DC LED Circuit	CPFL110-240V	50
Disconnection Plug		CIP	50
Width (Thickness) x Length x Height		6 x 28 x 35 mm	6 x 28 x 35 mm
* Current Rating		1 A	6.3 A
Marking Tags (Refer Pg. 268 for details)		CA509/K6WHT	100

Component Carrier	With Diode	CPD1	50
	For Ø 5 x 20 mm Fuse	CPF	50
	Fuse with 6-60V AC/DC LED Circuit	CPFL6-60V	50
	Fuse with 110-240V AC/DC LED Circuit	CPFL110-240V	50
Disconnection Plug		CIP	50
Width (Thickness) x Length x Height		6 x 28 x 35 mm	6 x 28 x 35 mm
* Current Rating		1 A	6.3 A
Marking Tags (Refer Pg. 268 for details)		CA509/K6WHT	100

Component Carrier	With Diode	CPD1	50
	For Ø 5 x 20 mm Fuse	CPF	50
	Fuse with 6-60V AC/DC LED Circuit	CPFL6-60V	50
	Fuse with 110-240V AC/DC LED Circuit	CPFL110-240V	50
Disconnection Plug		CIP	50
Width (Thickness) x Length x Height		6 x 28 x 35 mm	6 x 28 x 35 mm
* Current Rating		1 A	6.3 A
Marking Tags (Refer Pg. 268 for details)		CA509/K6WHT	100

Component Carrier	With Diode	CPD1	50
	For Ø 5 x 20 mm Fuse	CPF	50
	Fuse with 6-60V AC/DC LED Circuit	CPFL6-60V	50
	Fuse with 110-240V AC/DC LED Circuit	CPFL110-240V	50
Disconnection Plug		CIP	50
Width (Thickness) x Length x Height		6 x 28 x 35 mm	6 x 28 x 35 mm
* Current Rating		1 A	6.3 A
Marking Tags (Refer Pg. 268 for details)		CA509/K6WHT	100

TERMINAL BLOCKS WITH ELECTRONIC COMPONENTS

These are electronic series spring clamp double level Terminal Blocks with built in diodes and LED.

The built in diode acts as a free wheeling diode which is connected across the inductive load such as relay coils, solenoid valves, contactor coils to eliminate or suppress sudden voltage spike which appears across the load when its supply voltage is removed.

CXDL2.5(E)LD1 Terminal Block has a built in LED circuit for online indication.

CX2.5/4(E)D1 is specially designed 4 wire spring clamp Terminal Block with a built in diode. This Terminal has a built in 1N4007 diode for reverse polarity protection and also allows uni directional flow of current.

Width (Thickness) x Length	5 x 71 mm		
Height with DIN 35 x 7.5 / 35 x 15 mm Rail	49.5 mm / 57 mm		
Connection Possibility as per	IEC	UL - CSA	
With 1 Conductor per clamp	Stranded / Flexible	0.2 - 2.5 mm ²	24 - 12 AWG
	Solid	0.2 - 4.0 mm ²	24 - 10 AWG
	with Ferrule / Lug	0.2 - 2.5 mm ²	24 - 12 AWG
With 2 same size Conductors per clamp	with TWIN Ferrule / Lug	0.5 mm ²	20 AWG
Wire Stripping Length	10 mm		
Ratings As Per	IEC60947-7-1	UL-1059	CSA22.2-158
Voltage	1000 V	600 V	600 V
Current	1 A	1 A	
Approval			
Insulation Material / Comparative Tracking Index	Polyamide 66 / 1		
Rated Impulse Voltage / Pollution Degree	8 KV / 3		

	Type / Cat. No.	Standard Pack
End Plate	EPCXDL2.5	50
Mounting Rail (Refer Pg. 263 for details)	CA701-1M / CA701-1M-S	50 m
	CA701-15-1M / CA701-15-1M-S	25 m
End Clamp (Refer Pg. 264 for details)	CA103 / CA104	50
Warning Label	WLX2.5	100
Marking Tags (Refer Pg. 268 for details)	CA509/K5WHT	100
Marker Card (Refer Pg. 269 for details)	MC5	10
Screw Driver	SCM0.5/3 Blade size: 0.5 x 3.0 mm	10
Dual Marker Carrier	TM5	50

Jumpers	Type / Cat. No.	Imax	Standard Pack	
Pluggable Jumpers	2 pole	JX2.5/2	24 A	100
	3 pole	JX2.5/3	24 A	50
	4 pole	JX2.5/4	24 A	50
	5 pole	JX2.5/5	24 A	50
	6 pole	JX2.5/6	24 A	10
	7 pole	JX2.5/7	24 A	10
	8 pole	JX2.5/8	24 A	10
	10 pole	JX2.5/10	24 A	10
	20 pole	JX2.5/20	24 A	10
	Test Plug	TX2.5		20

Part No.	Application	Std. Pack
CXDL2.5(E)D1	Arc suppression circuit for contactors & solenoid valves - D.C	50

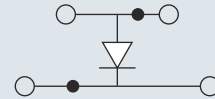
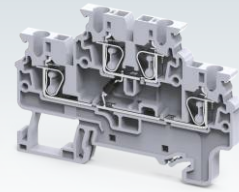

Part No.	Application	Std. Pack
CXDL2.5(E)D2	Arc suppression circuit for contactors & solenoid valves - D.C	50

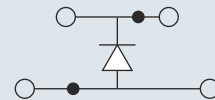
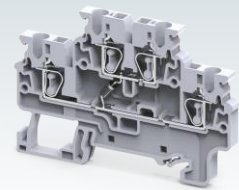

Part No.	Application	Std. Pack
CXDL2.5(E)D3	Diode circuit for reverse polarity protection	50

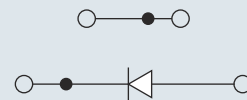
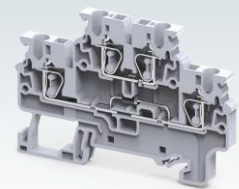

Part No.	Application	Std. Pack
CXDL2.5(E)DD1	Diode circuit for lamp testing	50

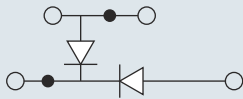
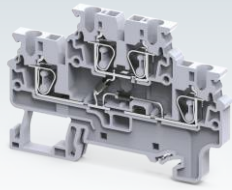

Part No.	Application	Std. Pack
CXDL2.5(E)DD2	Diode circuit for lamp testing	50

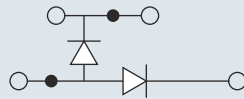
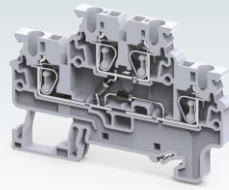

Part No.	Application	Std. Pack
CXDL2.5(E)DD3	Diode circuit for lamp testing	50

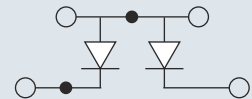
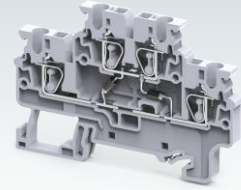

Part No.	Application	Std. Pack
CXDL2.5(E)DD4	Diode circuit for lamp testing	50

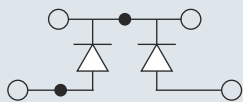
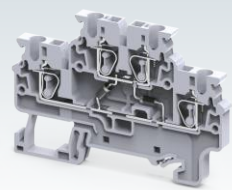

Part No.	Application	Std. Pack
CXDL2.5(E)LD1	DC Voltage indicator with LED	50

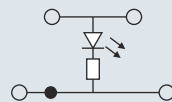
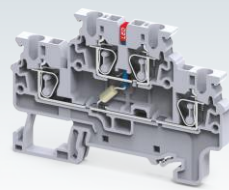

Part No.	Application	Std. Pack
CXDL2.5(E)TS1	Temperature sensor for measuring temperature	50

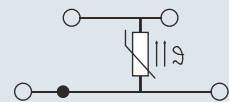
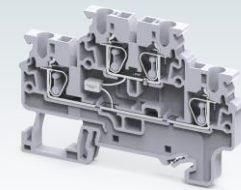

Part No.	Application	Std. Pack
CX2.5/4(E)D1	Arc suppression circuit for contactors & solenoid valves - D.C.	100
CX2.5/4(E)D2		100

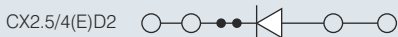
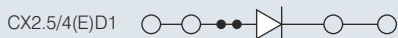
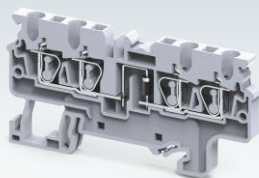

Part No.	Application	Std. Pack
CX2.5/4(E)R1		100
CX2.5/4(E)R2		100
CX2.5/4(E)R3		100
CX2.5/4(E)R4		100

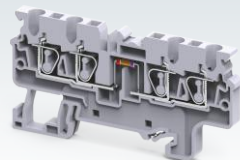

Width (Thickness) x Length	5 x 74.7 mm
Height with DIN 35 x 7.5 mm Rail	38 mm
Height with DIN 35 x 15 mm Rail	45.7 mm
End Plate	EPCX2.5/4 20
Partition Plate	PPCX4/4 20

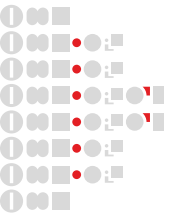

PLUGGABLE TERMINAL BLOCKS

as easy as
CHILD'S PLAY

0% Error

90% Faster

100% Secure

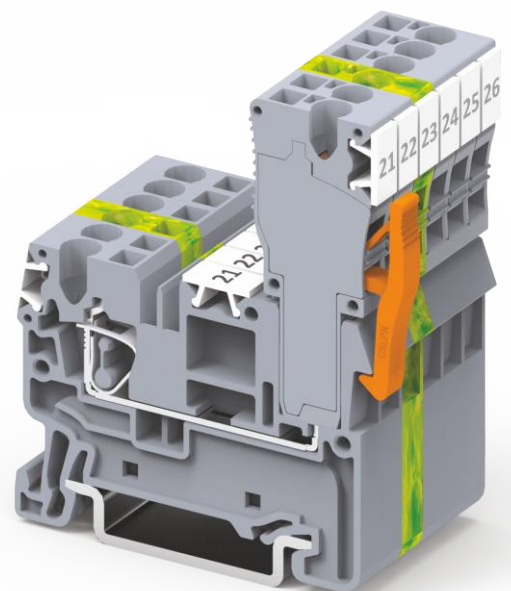

Scan
for more

Pluggable
Harnessing
Solutions

PLUGGABLE TERMINAL BLOCKS

Connectwell pluggable series Terminal Blocks are an excellent solution for creating wire harnesses which ease field wire connections.

CX2.5/1B terminal is DIN rail mounted base Terminal Block. Standard Jumpers and marking tags can be installed on the base terminal. The base Terminal Block has a provision for installing CX2.5PN series plugs.

CXDL2.5/2B terminal is a double level DIN rail mounted base Terminal Block. Standard Jumpers and marking tags can be installed on the base terminal. The base Terminal Block has a provision for installing CX2.5PN series plugs.

CX2.5PN series plugs can be inserted in standard base Terminal Blocks. CX2.5PLN should be used as a last covering element along with CX2.5PN terminals to make a complete assembly.

These plug assemblies can be polarized by cutting the integral stubs.

Subsequently standard polarizing pins CXPOLN can be used in the base Terminal Block to receive these polarized plugs.

CXLPN locking clips are installed on the plugs to ensure positive engagement with the base Terminal Block.

CXSR series strain relief plates are used in conjunction with the plug assemblies to secure wires using standard wire ties.







CX2.5SN is a free floating base terminal. CXDIN mounting feet can be installed on this free floating base terminal to enable mounting on DIN rails.









Various wire and plug receptacle base terminal options are available to create unique wire harnessing solutions.

Standard green yellow ground/earth base Terminal Blocks are also available for grounding applications.

Width (Thickness) x Length	
Height with DIN 35 x 7.5 / 35 x 15 mm Rail	
Connection Possibility as per	
With 1 Conductor per clamp	Stranded / Flexible
	Solid with Ferrule / Lug
With 2 same size Conductors per clamp	with TWIN Ferrule / Lug
Wire Stripping Length	
Ratings As Per	
Voltage	
Current	
Approval	
Insulation Material / Material Group	
Rated Impulse Voltage / Pollution Degree	

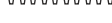
Terminal Block	Grey
----------------	------

Terminal Block	Ground / Earth
End Plate	
Partition Plate	
Mounting Rail (Refer Pg. 263 for details)	
End Clamp (Refer Pg. 264 for details)	
Warning Label	
Marking Tags (Refer Pg. 268 for details)	
Marker Card (Refer Pg. 269 for details)	
Coding Pin	
Screw Driver	

Jumpers		
Pluggable Jumpers		2 pole
		3 pole
		4 pole
		5 pole
		6 pole
		7 pole
		8 pole
		10 pole
		20 pole
	Test Plug	

CX2.5/1B

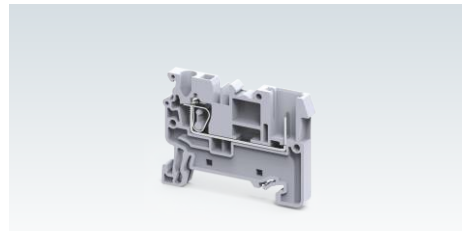

5 x 50.8 mm			
38.2 mm / 45.7 mm			
IEC		UL - CSA	
0.2 - 2.5 mm ²		24 - 12 AWG	
0.2 - 4.0 mm ²		24 - 10 AWG	
0.2 - 2.5 mm ²		24 - 12 AWG	
0.5 mm ²		20 AWG	
10 mm			
IEC60947-7-1	UL-1059	CSA22.2-158	IEC60079-7
500 V	300 V	600 V	630 V
24 A	20 A	20 A	21 A
			
Polyamide 6,6 / 1			
8 KV / 3			

Type / Cat. No.	Standard Pack
CX2.5/1B	100

CXG2.5/1B

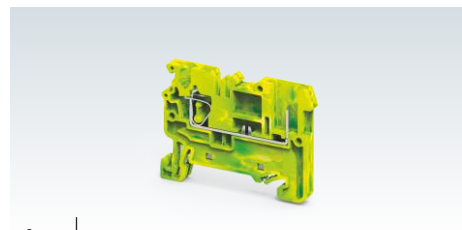

Type / Cat. No.	Standard Pack	
CXG2.5/1B	100	
EPCX2.5	50	
PPCX4	20	
CA701-1M / CA701-1M-S	50 m	
CA701-15-1M / CA701-15-1M-S	25 m	
CA103 / CA104	50	
WLX2.5	100	
CA509/K5WHT	100	
MC5	10	
CXPOLN	25	
SCM0.5/3	Blade size: 0.5 x 3 mm	10

Type / Cat. No.	I _{max}	Standard Pack
JX2.5/2	24 A	100
JX2.5/3	24 A	50
JX2.5/4	24 A	50
JX2.5/5	24 A	50
JX2.5/6	24 A	10
JX2.5/7	24 A	10
JX2.5/8	24 A	10
JX2.5/10	24 A	10
JX2.5/20	24 A	10
TX2.5		20

CX2.5/2B

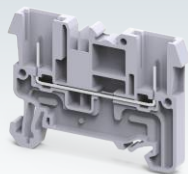

5 x 51.2 mm

38.2 mm / 45.7 mm

IEC	UL - CSA
-----	----------

0.2 - 2.5 mm ²	24 - 12 AWG
0.2 - 4.0 mm ²	24 - 10 AWG
0.2 - 2.5 mm ²	24 - 12 AWG

CX2.5/3/1B

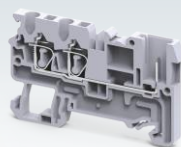

5 x 63 mm

38.2 mm / 45.7 mm

IEC	UL - CSA
-----	----------

0.2 - 2.5 mm ²	24 - 12 AWG
0.2 - 4.0 mm ²	24 - 10 AWG
0.2 - 2.5 mm ²	24 - 12 AWG

0.5 mm² 20 AWG

10 mm

IEC60947-7-1 UL-1059 CSA22.2-158 IEC60079-7

500 V	300 V	600 V	630 V
-------	-------	-------	-------

24 A	20 A	20 A	21 A
------	------	------	------



Polyamide 6,6 / 1

8 KV / 3

Type / Cat. No.	Standard Pack
-----------------	---------------

CX2.5/2B	100
----------	-----

CX2.5/3/1B

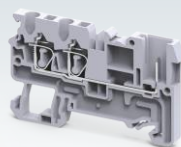

5 x 63 mm

38.2 mm / 45.7 mm

IEC	UL - CSA
-----	----------

0.2 - 2.5 mm ²	24 - 12 AWG
0.2 - 4.0 mm ²	24 - 10 AWG
0.2 - 2.5 mm ²	24 - 12 AWG

0.5 mm² 20 AWG

10 mm

IEC60947-7-1 UL-1059 CSA22.2-158 IEC60079-7

500 V	300 V	600 V	630 V
-------	-------	-------	-------

24 A	20 A	20 A	21 A
------	------	------	------



Polyamide 6,6 / 1

8 KV / 3

Type / Cat. No.	Standard Pack
-----------------	---------------

CX2.5/3/1B	100
------------	-----

CX2.5/4/2B



5 x 83.5 mm

38.2 mm / 45.7 mm

IEC	UL - CSA
-----	----------

0.2 - 2.5 mm ²	24 - 12 AWG
0.2 - 4.0 mm ²	24 - 10 AWG
0.2 - 2.5 mm ²	24 - 12 AWG

0.5 mm² 20 AWG

10 mm

IEC60947-7-1 UL-1059 CSA22.2-158 IEC60079-7

500 V	300 V	600 V	630 V
-------	-------	-------	-------

24 A	20 A	20 A	21 A
------	------	------	------



Polyamide 6,6 / 1

8 KV / 3

Type / Cat. No.	Standard Pack
-----------------	---------------

CX2.5/4/2B	50
------------	----

CXG2.5/2B

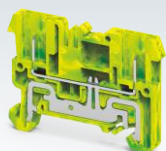

Type / Cat. No.	Standard Pack
-----------------	---------------

CXG2.5/2B	100
-----------	-----

EPCX2.5	50
---------	----

PPCX4	20
-------	----

CA701-1M / CA701-1M-S	50 m
-----------------------	------

CA701-15-1M / CA701-15-1M-S	25 m
-----------------------------	------

CA103 / CA104	50
---------------	----

WLX2.5	100
--------	-----

CA509/K5WHT	100
-------------	-----

MC5	10
-----	----

CXPOLN	25
--------	----

SCM0.5/3 Blade size: 0.5 x 3 mm	10
---------------------------------	----

Type / Cat. No.	I _{max}	Standard Pack
-----------------	------------------	---------------

JX2.5/2	24 A	100
---------	------	-----

JX2.5/3	24 A	50
---------	------	----

JX2.5/4	24 A	50
---------	------	----

JX2.5/5	24 A	50
---------	------	----

JX2.5/6	24 A	10
---------	------	----

JX2.5/7	24 A	10
---------	------	----

JX2.5/8	24 A	10
---------	------	----

JX2.5/10	24 A	10
----------	------	----

JX2.5/20	24 A	10
----------	------	----

TX2.5		20
-------	--	----

CXG2.5/3/1B

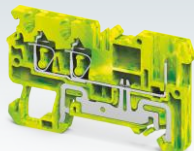

Type / Cat. No.	Standard Pack
-----------------	---------------

CXG2.5/3/1B	100
-------------	-----

EPCX2.5/3	50
-----------	----

PPCX4/3	20
---------	----

CA701-1M / CA701-1M-S	50 m
-----------------------	------

CA701-15-1M / CA701-15-1M-S	25 m
-----------------------------	------

CA103 / CA104	50
---------------	----

WLX2.5	100
--------	-----

CA509/K5WHT	100
-------------	-----

MC5	10
-----	----

CXPOLN	25
--------	----

SCM0.5/3 Blade size: 0.5 x 3 mm	10
---------------------------------	----

Type / Cat. No.	I _{max}	Standard Pack
-----------------	------------------	---------------

JX2.5/2	24 A	100
---------	------	-----

JX2.5/3	24 A	50
---------	------	----

JX2.5/4	24 A	50
---------	------	----

JX2.5/5	24 A	50
---------	------	----

JX2.5/6	24 A	10
---------	------	----

JX2.5/7	24 A	10
---------	------	----

JX2.5/8	24 A	10
---------	------	----

JX2.5/10	24 A	10
----------	------	----

JX2.5/20	24 A	10
----------	------	----

TX2.5		20
-------	--	----

CXG2.5/4/2B

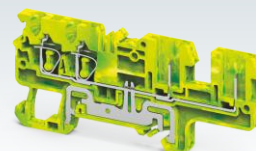

Type / Cat. No.	Standard Pack
-----------------	---------------

CXG2.5/4/2B	100
-------------	-----

EPCX2.5/4/2B	50
--------------	----

CA701-1M / CA701-1M-S	50 m
-----------------------	------

CA701-15-1M / CA701-15-1M-S	25 m
-----------------------------	------

CA103 / CA104	50
---------------	----

WLX2.5	100
--------	-----

CA509/K5WHT	100
-------------	-----

MC5	10
-----	----

CXPOLN	25
--------	----

SCM0.5/3 Blade size: 0.5 x 3 mm	10
---------------------------------	----

Type / Cat. No.	I _{max}	Standard Pack
-----------------	------------------	---------------

JX2.5/2	24 A	100
---------	------	-----

JX2.5/3	24 A	50
---------	------	----

JX2.5/4	24 A	50
---------	------	----

JX2.5/5	24 A	50
---------	------	----

JX2.5/6	24 A	10
---------	------	----

JX2.5/7	24 A	10
---------	------	----

JX2.5/8	24 A	10
---------	------	----

JX2.5/10	24 A	10
----------	------	----

JX2.5/20	24 A	10
----------	------	----

TX2.5		20
-------	--	----

PLUGGABLE TERMINAL BLOCKS

CX2.5/4/4B

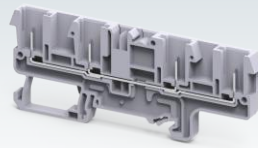

Width (Thickness) x Length	5 x 97.2 mm			
Height with DIN 35 x 7.5 / 35 x 15 mm Rail	38.2 mm / 45.7 mm			
Connection Possibility as per	IEC		UL - CSA	
With 1 Conductor per clamp	Stranded / Flexible			
	Solid with Ferrule / Lug			
With 2 same size Conductors per clamp	with TWIN Ferrule / Lug			
Wire Stripping Length	10 mm			
Ratings As Per	IEC60947-7-1	UL-1059	CSA22.2-158	IEC60079-7
Voltage	500 V	300 V	600 V	630 V
Current	24 A	20 A	20 A	21 A
Approval	CE			
Insulation Material / Material Group	Polyamide 6,6 / 1			
Rated Impulse Voltage / Pollution Degree	8 KV / 3			

Type / Cat. No.	Standard Pack
CX2.5/4/4B	50

Terminal Block Grey

CXDL2.5/2B

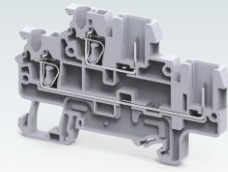

Width (Thickness) x Length	5 x 78 mm			
Height with DIN 35 x 7.5 / 35 x 15 mm Rail	49.5 mm / 57 mm			
Connection Possibility as per	IEC		UL - CSA	
With 1 Conductor per clamp	0.2 - 2.5 mm ²		24 - 12 AWG	
	0.2 - 4.0 mm ²		24 - 10 AWG	
	0.2 - 2.5 mm ²		24 - 12 AWG	
With 2 same size Conductors per clamp	0.5 mm ²		20 AWG	
Wire Stripping Length	10 mm			
Ratings As Per	IEC60947-7-1	UL-1059	CSA22.2-158	IEC60079-7
Voltage	500 V	300 V	600 V	630 V
Current	24 A	20 A	20 A	21 A
Approval	CE			
Insulation Material / Material Group	Polyamide 6,6 / 1			
Rated Impulse Voltage / Pollution Degree	8 KV / 3			

Type / Cat. No.	Standard Pack
CXDL2.5/2B	50

CXG2.5/4/4B

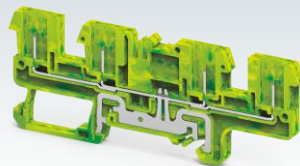

Type / Cat. No.	Standard Pack
CXG2.5/4/4B	50
EPCX2.5/4/4B	50
CA701-1M / CA701-1M-S	50 m
CA701-15-1M / CA701-15-1M-S	25 m
CA103 / CA104	50
WLX2.5	100
CA509/K5WHT	100
MC5	10
CXPOLN	25
SCM0.5/3 Blade size: 0.5 x 3 mm	10

Terminal Block Ground / Earth

End Plate 

Partition Plate 

Mounting Rail (Refer Pg. 263 for details) 

End Clamp (Refer Pg. 264 for details) 

Warning Label

Marking Tags (Refer Pg. 268 for details) 

Marker Card (Refer Pg. 269 for details)

Coding Pin

Screw Driver 

CXDLG2.5/2B

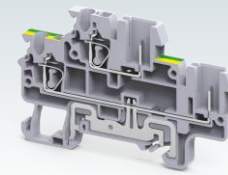

Type / Cat. No.	Standard Pack
CXDLG2.5/2B	50
EPCXDL2.5/2B	50
CA701-1M / CA701-1M-S	50 m
CA701-15-1M / CA701-15-1M-S	25 m
CA103 / CA104	50
WLX2.5	100
CA509/K5WHT	100
MC5	10
CXPOLN	25
SCM0.5/3 Blade size: 0.5 x 3 mm	10

Terminal Block Ground / Earth

End Plate 

Partition Plate 

Mounting Rail (Refer Pg. 263 for details) 

End Clamp (Refer Pg. 264 for details) 

Warning Label

Marking Tags (Refer Pg. 268 for details) 

Marker Card (Refer Pg. 269 for details)

Coding Pin

Screw Driver 

Jumpers	Type / Cat. No.	I _{max}	Standard Pack
Pluggable Jumpers 	JX2.5/2	24 A	100
	JX2.5/3	24 A	50
	JX2.5/4	24 A	50
	JX2.5/5	24 A	50
	JX2.5/6	24 A	10
	JX2.5/7	24 A	10
	JX2.5/8	24 A	10
	JX2.5/10	24 A	10
	JX2.5/20	24 A	10
	Test Plug	TX2.5	

CXDL2.5/2B(I.S)

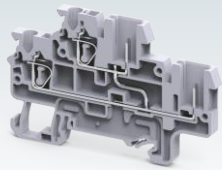

5 x 78 mm

49.5 mm / 57 mm

IEC	UL - CSA
0.2 - 2.5 mm ²	24 - 12 AWG
0.2 - 4.0 mm ²	24 - 10 AWG
0.2 - 2.5 mm ²	24 - 12 AWG
0.5 mm ²	20 AWG

10 mm

IEC60947-7-1	UL-1059	CSA22.2-158	IEC60079-7
500 V	300 V	600 V	630 V
24 A	20 A	20 A	21 A



Polyamide 6,6 / 1

8 KV / 3

Type / Cat. No.	Standard Pack
CXDL2.5/2B(I.S)	50

CXDLG2.5/2B(I.S)

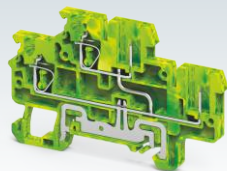

Type / Cat. No.	Standard Pack
CXDLG2.5/2B(I.S)	50
EPCXDL2.5/2B	50

CA701-1M / CA701-1M-S	50 m	
CA701-15-1M / CA701-15-1M-S	25 m	
CA103 / CA104	50	
WLX2.5	100	
CA509/K5WHT	100	
MC5	10	
CXPOLN	25	
SCM0.5/3	Blade size: 0.5 x 3 mm	10

Type / Cat. No.	I _{max}	Standard Pack
JX2.5/2	24 A	100
JX2.5/3	24 A	50
JX2.5/4	24 A	50
JX2.5/5	24 A	50
JX2.5/6	24 A	10
JX2.5/7	24 A	10
JX2.5/8	24 A	10
JX2.5/10	24 A	10
JX2.5/20	24 A	10
TX2.5		20

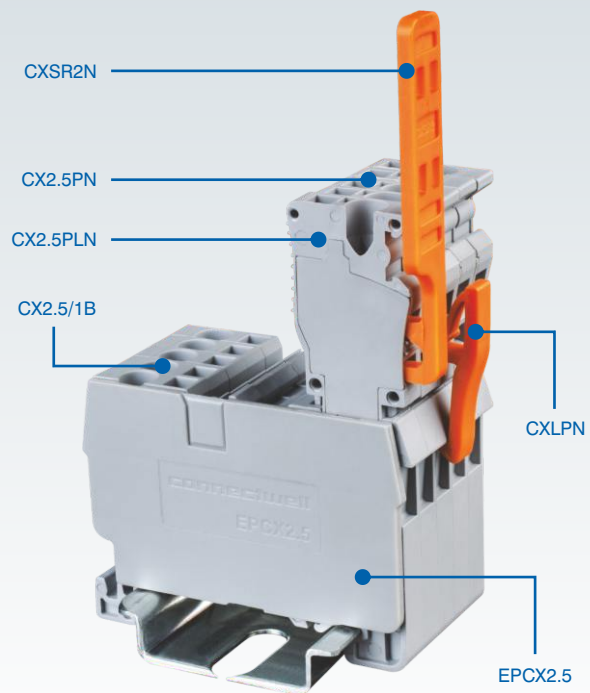

1

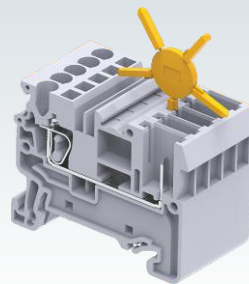

Insert coding pin CXPOLN in the base Terminal Block. Twist to break.

2



Remove the coding pin from female plug using a cutting tool

3

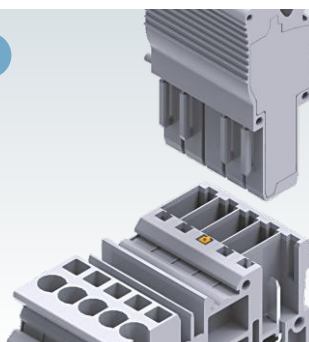

Polarized plug assemblies can then be inserted in the respective base terminal

PLUGGABLE TERMINAL BLOCKS

CX2.5PN



CX2.5SN



Width (Thickness) x Length	5 x 17.5 mm	
Height	42 mm	
Connection Possibility as per	IEC	
With 1 Conductor per clamp	Stranded / Flexible	0.2 - 2.5 mm ²
		Solid
	with Ferrule / Lug	0.2 - 4.0 mm ²
With 2 same size Conductors per clamp	with TWIN Ferrule / Lug	0.2 - 2.5 mm ²
		0.5 mm ²
Wire Stripping Length	10 mm	
Ratings As Per	IEC60947-7-1 UL-1059	
Voltage	500 V	300 V
Current	24 A	20 A
Approvals		
Insulation Material / Material Group	Polyamide 6,6 / 1	
Rated Impulse Voltage / Pollution Degree	8 KV / 3	

Width (Thickness) x Length	5 (With End Plate 7.5 mm) x 18 mm	
Height	40 mm	
Connection Possibility as per	IEC	
With 1 Conductor per clamp	Stranded / Flexible	0.2 - 2.5 mm ²
		Solid
	with Ferrule / Lug	0.2 - 4.0 mm ²
With 2 same size Conductors per clamp	with TWIN Ferrule / Lug	0.2 - 2.5 mm ²
		0.5 mm ²
Wire Stripping Length	10 mm	
Ratings As Per	IEC60947-7-1 UL-1059	
Voltage	500 V	300 V
Current	24 A	20 A
Approvals		
Insulation Material / Material Group	Polyamide 6,6 / 1	
Rated Impulse Voltage / Pollution Degree	8 KV / 3	

		No. of Poles	Type / Cat. No.	Standard Pack
Connector	Start Element	1	CX2.5PN	50
	Last Element	1	CX2.5PLN	50
		2	CX2.5PN/2	50
		3	CX2.5PN/3	50
		4	CX2.5PN/4	50
		5	CX2.5PN/5	50
		6	CX2.5PN/6	25
		7	CX2.5PN/7	25
		8	CX2.5PN/8	25
		9	CX2.5PN/9	25
		10	CX2.5PN/10	25
		11	CX2.5PN/11	10
		12	CX2.5PN/12	10
		13	CX2.5PN/13	10
		14	CX2.5PN/14	10
	15	CX2.5PN/15	10	
End Plate				
Locking Clip			CXLPN	25
2 Pole Locking Clip			CXLP2N	25
2 Way Strain Relief			CXSR2N	25
4 Way Strain Relief			CXSR4N	25
Mounting Feet				
Coding Pin				
Mounting Rail (Refer Pg. 263 for details)			CA701-1M / CA701-1M-S	50 m
			CA701-15-1M / CA701-15-1M-S	25 m
Screw Driver for actuating the Spring Clamp			SCM0.5/3 Blade size: 0.5 x 3 mm	10
Marking Tags (Refer Pg. 268 for details)			CA509/K5WHT	100
Marker Card (Refer Pg. 269 for details)			MC5	10

		No. of Poles	Type / Cat. No.	Standard Pack
Connector				
End Plate			EPCX2.5SN	50
Locking Clip				
2 Pole Locking Clip				
2 Way Strain Relief			CXSR2N	25
4 Way Strain Relief			CXSR4N	25
Mounting Feet			CXDIN	25
Coding Pin			CXPOLN	25
Mounting Rail (Refer Pg. 263 for details)			CA701-1M / CA701-1M-S	50 m
			CA701-15-1M / CA701-15-1M-S	25 m
Screw Driver for actuating the Spring Clamp			SCM0.5/3 Blade size: 0.5 x 3 mm	10
Marking Tags (Refer Pg. 268 for details)			CA509/K5WHT	100
Marker Card (Refer Pg. 269 for details)			MC5	10

Jumpers	Type / Cat. No.	Imax	Standard Pack
Pluggable Jumpers	2 pole		
	3 pole		
	4 pole		
	5 pole		
	6 pole		
	7 pole		
	8 pole		
	10 pole		
	20 pole		

Jumpers	Type / Cat. No.	Imax	Standard Pack
2 pole			
3 pole			
4 pole			
5 pole			
6 pole			
7 pole			
8 pole			
10 pole			
20 pole			

		No. of Poles	Type / Cat. No.	Standard Pack
Connector				
End Plate			EPCX2.5SN	50
Locking Clip				
2 Pole Locking Clip				
2 Way Strain Relief			CXSR2N	25
4 Way Strain Relief			CXSR4N	25
Mounting Feet			CXDIN	25
Coding Pin			CXPOLN	25
Mounting Rail (Refer Pg. 263 for details)			CA701-1M / CA701-1M-S	50 m
			CA701-15-1M / CA701-15-1M-S	25 m
Screw Driver for actuating the Spring Clamp			SCM0.5/3 Blade size: 0.5 x 3 mm	10
Marking Tags (Refer Pg. 268 for details)			CA509/K5WHT	100
Marker Card (Refer Pg. 269 for details)			MC5	10

Jumpers	Type / Cat. No.	Imax	Standard Pack
2 pole			
3 pole			
4 pole			
5 pole			
6 pole			
7 pole			
8 pole			
10 pole			
20 pole			

CY SERIES SCREW CLAMP

TERMINAL BLOCKS

These next generation Terminal Blocks use the proven & robust Connectwell screw clamp system for the most stringent application requirements. The CY series terminals offer various advantages to the user which includes pluggable jumpers, unified and minimal accessory requirements and ability to affix marking tags on the top surface.

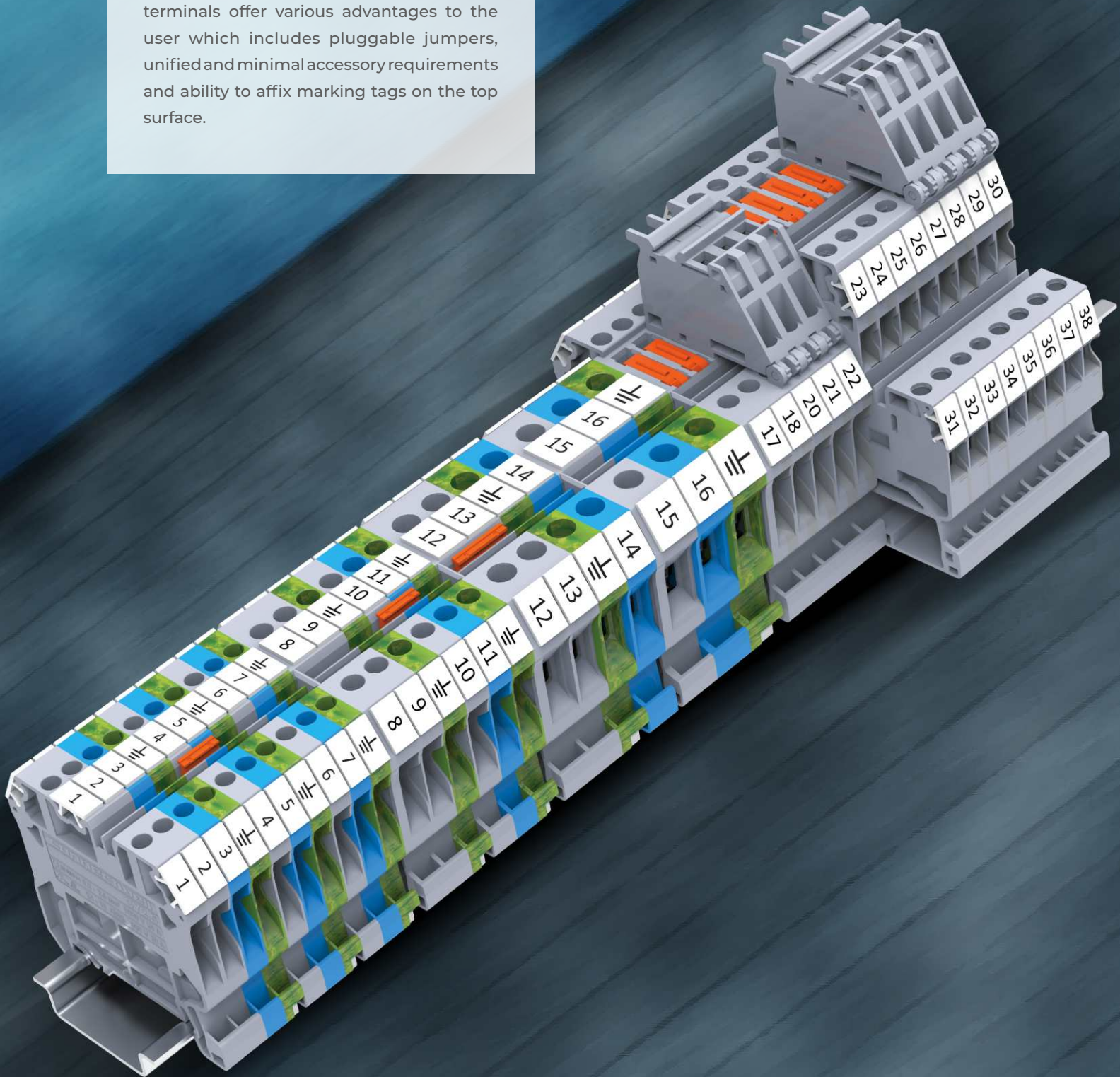

CY SERIES SCREW CLAMP TERMINAL BLOCKS



Feed Through

109 - 111



Ground / Earth

112 - 114



Multiple Connection

115 - 116



Multiple Level

117 - 120



Fuse Terminal

121 - 124



Disconnect & Test

125 - 127



Electronic Components

128 - 130

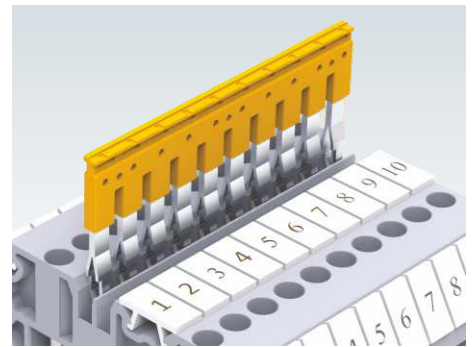
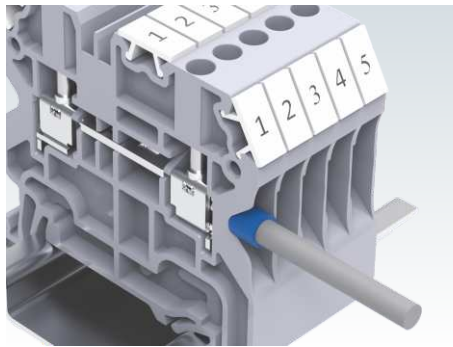
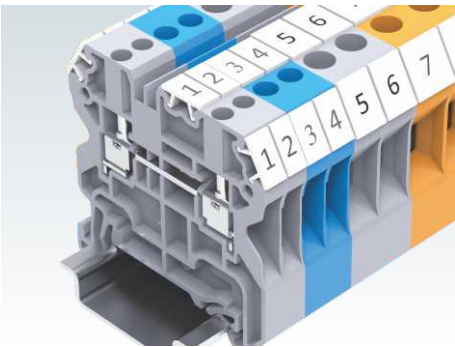

New CY series Terminal Blocks use the proven and robust Connectwell Screw Clamp system. A wide range of feed through terminals are available for wire sizes ranging from 0.2mm² to 10 mm².

A unique design in the plastic housing of the Terminal Block facilitates ease of wire entry. Wires can be used with or without ferrules/Lugs.

Easy to use push in jumpers for shorting Terminal Blocks are now available in 2,3,4, & 10 pole configuration

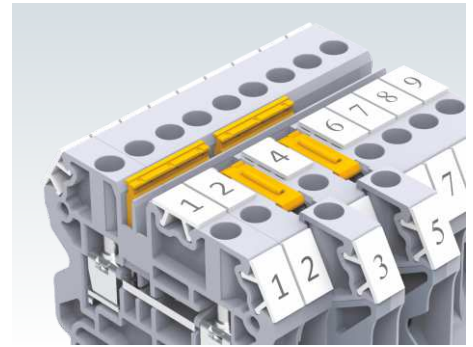
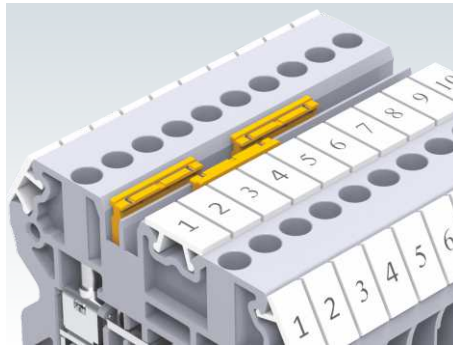
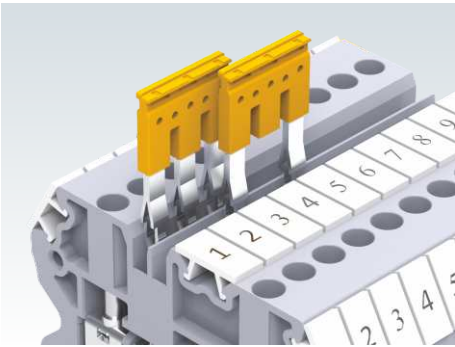

Specific Terminal Blocks in an assembly can be shorted by breaking intermediate contacts from the standard jumpers.

The possibility of using 2 independent rows for bridging enables the creation of various circuit combinations. Jumpers can be marked with a felt tip pen on the recess provided on top, to clearly indicate shorted positions.

The jumper and marking tag position is aligned across different types of CY series Terminal Blocks. This facilitates shorting and marking adjacent terminals with different functionalities.

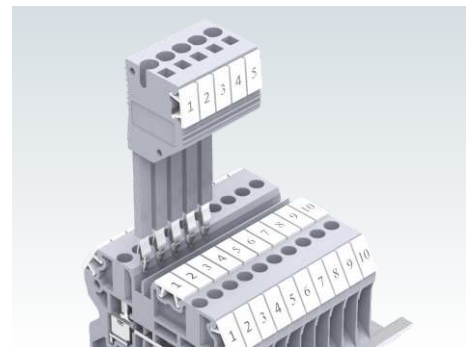
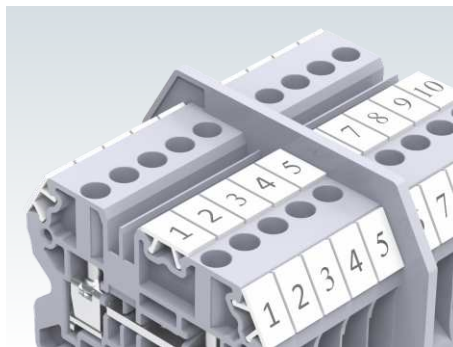
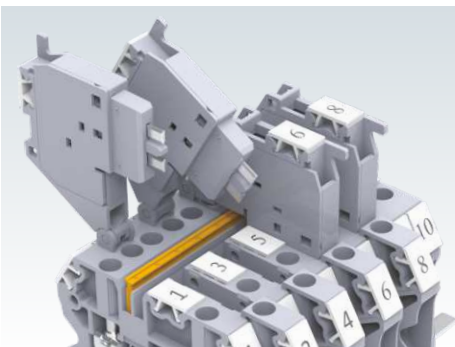

Feed through Terminal Blocks can be simultaneously shorted in an alternating configuration with fuse & Disconnecting Terminal Blocks using pluggable jumpers.

Partition Plates can be individually mounted on Din rails between Terminals Blocks to provide electrical and visual separation.

Specially designed Test Plugs are available for CY series Terminal Blocks for quick testing and measurement.

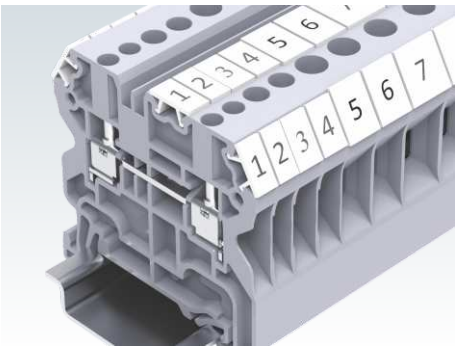

A high torque clamping system on the screw clamp Terminal Blocks ensures safe, gas tight connections. While cold forged, rolled threaded screws ensure highly reliable connections. Standard feed through are of same dimensions with difference in thickness.

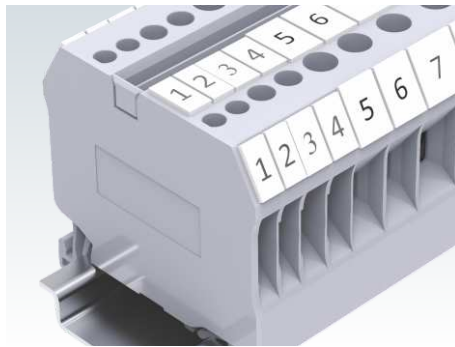

A single end plate can be used for a wide range of feed through terminals.

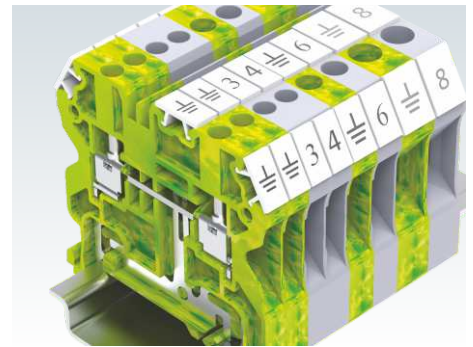

Same profile grounding terminals are clearly identified with a green-yellow housing. Their shape and thickness is identical to the Feed Trough Terminal Blocks

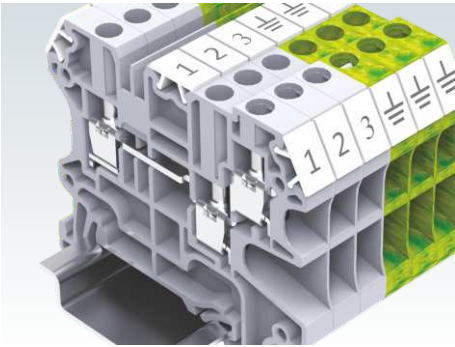

Multi connection Terminal Blocks are used for applications involving more than one same potential wires to be connected.

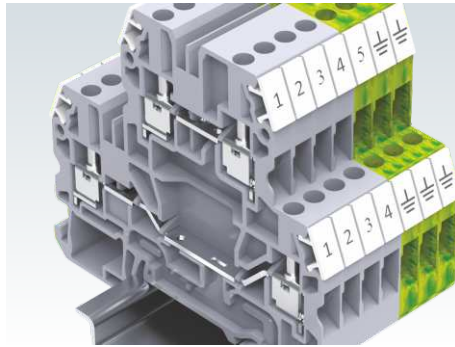

Double level Terminal Blocks enable high density wiring. Each Level can be independently shorted to suit various applications. These Terminal Blocks are an ideal choice for space saving applications.

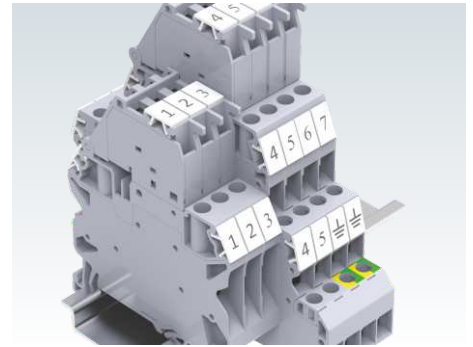

These Fuse Terminal Blocks can be used for Ø 5 x 20 and Ø 5 x 25 cartridge fuses.

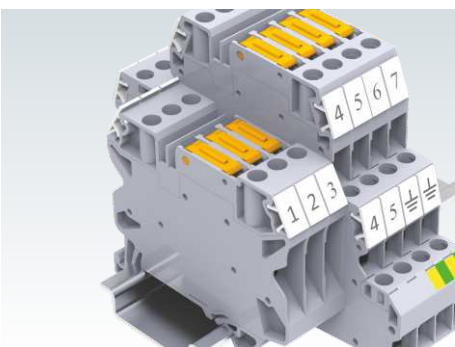







The Screw clamp knife disconnect terminal system enables isolation of circuits. A standard test plug can be used with these Terminal Blocks.

FEED THROUGH TERMINAL BLOCKS

CY series screw clamp Terminal Blocks are the next generation terminals with an improved 1000 V rating as per IEC guidelines. Feed through terminals of different wire sizes have the same outer profile.

Cross connection of these Terminal Blocks can be done using insulated pluggable jumpers, available in various pole configurations.

The terminals with  & IECEx approval can be used in potentially explosive atmosphere. For detailed information refer page 289.

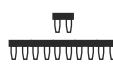
Width (Thickness) x Length		5 x 50 mm			
Height with DIN 35 x 7.5 / 35 x 15 mm Rail		49 mm / 56.5 mm			
Connection Possibility as per		IEC		UL - CSA	
With 1 Conductor per clamp	Stranded / Flexible	0.2 - 2.5 mm ²		24 - 14 AWG	
	Solid	0.2 - 4.0 mm ²		24 - 12 AWG	
	with Ferrule / Lug	0.2 - 2.5 mm ²		24 - 14 AWG	
With 2 same size Conductors per clamp	with TWIN Ferrule / Lug	0.5 - 1.5 mm ²		20 - 16 AWG	
Wire Stripping Length		8 mm			
Ratings As Per		IEC60947-7-1	UL-1059	CSA22.2-158	IEC60079-7
Voltage		1000 V	600 V	600 V	800 V
Current		24 A	20 A	20 A	21 A
Torque		0.4 Nm	4.5 lb.in	4.5 lb.in	0.4 Nm
Approval					
Insulation Material / Material Group		Polyamide 6,6 / 1			
Rated Impulse Voltage / Pollution Degree		8 KV / 3			
		Type / Cat. No.		Standard Pack	
Terminal Block	Grey	CY2.5		100	
	Blue	CY2.5BU		100	
	Red	CY2.5R		100	
	Yellow	CY2.5Y		100	
	Black	CY2.5BK		100	
	Green	CY2.5GN		100	
	Ground / Earth	CYG2.5 (Refer Pg. 112 for details)		100	
End Plate 		EPCY2.5/10		50	
Partition Plate 		PPCY2.5/10		20	
Mounting Rail (Refer Pg. 263 for details) 		CA701-1M / CA701-1M-S		50 m	
		CA701-15-1M / CA701-15-1M-S		25 m	
End Clamp (Refer Pg. 264 for details) 		CA702 / CA802		50	
Test Plug		TX2.5		20	
Marking Tags (Refer Pg. 268 for details) 		CA509/K5WHT		100	
Marker Card (Refer Pg. 269 for details)		MC5		10	
Screw Driver 		SCS0.5/3 Blade size: 0.5 x 3.0 mm		10	
Jumpers		Type / Cat. No.		Imax	Standard Pack
Pluggable Jumpers 	2 pole	JX2.5/2		24 A	100
	3 pole	JX2.5/3		24 A	50
	4 pole	JX2.5/4		24 A	50
	5 pole	JX2.5/5		24 A	50
	6 pole	JX2.5/6		24 A	10
	7 pole	JX2.5/7		24 A	10
	8 pole	JX2.5/8		24 A	10
	10 pole	JX2.5/10		24 A	10
	16 pole				
	20 pole	JX2.5/20		24 A	10
Step Down Jumpers		JYS6/2.5		24 A	20
		JYS10/2.5		24 A	20

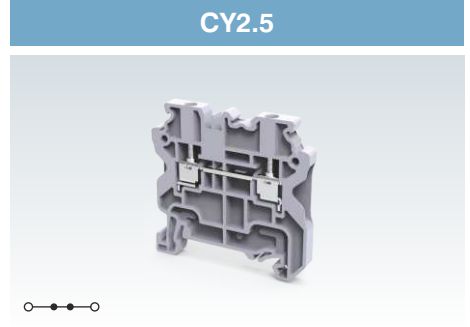

CY4



6 x 50 mm

49 mm / 56.5 mm

IEC	UL - CSA
0.2 - 4.0 mm ²	24 - 10 AWG
0.2 - 6.0 mm ²	
0.2 - 4.0 mm ²	24 - 12 AWG
0.5 - 2.5 mm ²	20 - 14 AWG

9 mm

IEC60947-7-1 UL-1059 CSA22.2-158 IEC60079-7

1000 V	600 V	600 V	800 V
32 A	30 A	30 A	28 A
0.5 Nm	4.5 lb.in	4.5 lb.in	0.5 Nm



Polyamide 6,6 / 1

8 KV / 3

Type / Cat. No.	Standard Pack	
CY4	100	
CY4BU	100	
CY4R	100	
CY4Y	100	
CY4BK	100	
CY4GN	100	
CY4 (Refer Pg. 113 for details)	100	
EPCY2.5/10	50	
PPCY2.5/10	20	
CA701-1M / CA701-1M-S	50 m	
CA701-15-1M / CA701-15-1M-S	25 m	
CA702 / CA802	50	
CA509/K6WHT	100	
MC6	10	
SCS0.6/3.5 Blade size: 0.6 x 3.0 mm	10	
Type / Cat. No.	I _{max}	Standard Pack
JX4/2	32 A	100
JX4/3	32 A	50
JX4/4	32 A	50
JX4/5	32 A	50
JX4/6	32 A	50
JX4/8	32 A	10
JX4/10	32 A	10
JX4/16	32 A	10

CY6



8 x 50 mm

49 mm / 56.5 mm

IEC	UL - CSA
0.2 - 6.0 mm ²	24 - 8 AWG
0.2 - 10.0 mm ²	
0.2 - 6.0 mm ²	24 - 8 AWG
0.5 - 4.0 mm ²	20 - 12 AWG

10 mm

IEC60947-7-1 UL-1059 CSA22.2-158 IEC60079-7

1000 V	600 V	600 V	630 V
41 A	50 A	50 A	36 A
0.8 Nm	11 lb.in	11 lb.in	0.8 Nm



Polyamide 6,6 / 1

8 KV / 3

Type / Cat. No.	Standard Pack	
CY6	100	
CY6BU	100	
CY6R	100	
CY6Y	100	
CY6BK	100	
CY6GN	100	
CY6 (Refer Pg. 113 for details)	100	
EPCY2.5/10	50	
PPCY2.5/10	20	
CA701-1M / CA701-1M-S	50 m	
CA701-15-1M / CA701-15-1M-S	25 m	
CA702 / CA802	50	
CA509/K8WHT	100	
MC8	10	
SCS0.8/4 Blade size: 0.8 x 4 mm	10	
Type / Cat. No.	I _{max}	Standard Pack
JY6/2	35 A	100
JY6/3	35 A	50
JY6/4	35 A	50
JY6/5	35 A	50
JY6/6	35 A	10
JY6/7	35 A	10
JY6/8	35 A	10
JY6/10	35 A	10
JYS6/2.5	24 A	20

CY10

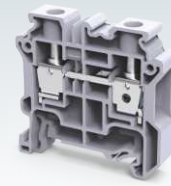

10 x 50 mm

49 mm / 56.5 mm

IEC	UL - CSA
0.2 - 10.0 mm ²	24 - 6 AWG
0.2 - 10.0 mm ²	
0.2 - 10.0 mm ²	24 - 6 AWG
0.5 - 6.0 mm ²	

11 mm

IEC60947-7-1 UL-1059 CSA22.2-158 IEC60079-7

1000 V	600 V	600 V	630 V
57 A	65 A	65 A	51 A
1.2 Nm	14 lb.in	14 lb.in	1.2 Nm



Polyamide 6,6 / 1





8 KV / 3

Type / Cat. No.	Standard Pack	
CY10	50	
CY10BU	50	
CY10R	50	
CY10Y	50	
CY10BK	50	
CY10GN	50	
CY10 (Refer Pg. 114 for details)	50	
EPCY2.5/10	50	
PPCY2.5/10	20	
CA701-1M / CA701-1M-S	50 m	
CA701-15-1M / CA701-15-1M-S	25 m	
CA702 / CA802	50	
CA509/K10WHT	100	
MC10	10	
SCS0.8/4 Blade size: 0.8 x 4 mm	10	
Type / Cat. No.	I _{max}	Standard Pack
JY10/2	50 A	20
JYS10/2.5	24 A	20

FEED THROUGH TERMINAL BLOCKS

CY series screw clamp Terminal Blocks are the next generation terminals with an improved 1000 V rating as per IEC guidelines. Feed through terminals of different wire sizes have the same outer profile.

Cross connection of these Terminal Blocks can be done using insulated pluggable jumpers, available in various pole configurations.

Width (Thickness) x Length		12 x 58.9 mm		
Height with DIN 35 x 7.5 / 35 x 15 mm Rail		50.8 mm / 51.2 mm		
Connection Possibility as per		IEC	UL - CSA	
With 1 Conductor per clamp	Stranded / Flexible	1.5 - 16.0 mm ²	16 - 4 AWG	
	Solid with Ferrule / Lug	1.5 - 16.0 mm ²	16 - 4 AWG	
With 2 same size Conductors per clamp	with TWIN Ferrule / Lug	0.5 - 10.0 mm ²		
Wire Stripping Length		14 mm		
Ratings As Per		IEC60947-7-1 UL-1059		
Voltage		1000 V	600 V	
Current		76 A	85 A	
Torque		2.5 Nm	14 lb.in	
Approval		CE		
Insulation Material / Material Group		Polyamide 6,6 / 1		
Rated Impulse Voltage / Pollution Degree		8 KV / 3		
		Type / Cat. No.	Standard Pack	
Terminal Block	Grey Ground / Earth	CY16	50	
		CYG16 (Refer Pg. 114 for details)	50	
Mounting Rail (Refer Pg. 263 for details)		CA701-1M / CA701-1M-S	50 m	
		CA701-15-1M / CA701-15-1M-S	25 m	
End Clamp (Refer Pg. 264 for details)		CA702 / CA802	50	
Marking Tags (Refer Pg. 268 for details)		CA509/K12WHT	100	
Marker Card (Refer Pg. 269 for details)		MC12	10	
Screw Driver		SCS1.0/5.5 Blade size: 1.0 x 5.5 mm	10	
		Type / Cat. No.	I_{max}	Standard Pack
Pluggable Jumpers	 2 pole	JY16/2	76 A	20

CY16

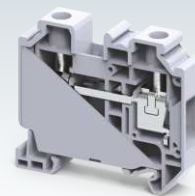







GROUND / EARTH TERMINAL BLOCKS

CYG series are earthing Terminal Blocks with specially designed alloy feet which help in achieving very low contact resistance and vibration proof grounding with the DIN rails. They are green / yellow colour coded as per industry standards.

Cross connection of these Terminal Blocks can be done using standard pluggable jumpers.

The terminals with  & IECEx approval can be used in potentially explosive atmosphere. For detailed information refer page 289.

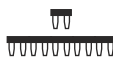
		CYG2.5				
Width (Thickness) x Length		5 x 50 mm				
Height with DIN 35 x 7.5 / 35 x 15 mm Rail		49 mm / 56.5 mm				
Connection Possibility as per		IEC		UL - CSA		
With 1 Conductor per clamp	Stranded / Flexible	0.2 - 2.5 mm ²		24 - 14 AWG		
	Solid	0.2 - 4.0 mm ²		24 - 12 AWG		
	with Ferrule / Lug	0.2 - 2.5 mm ²		24 - 14 AWG		
With 2 same size Conductors per clamp	with TWIN Ferrule / Lug	0.5 - 1.5 mm ²		20 - 16 AWG		
Wire Stripping Length		8 mm				
Ratings As Per		IEC60947-2	UL-1059	CSA22.2-158	IEC60079-7	
Torque		0.4 Nm	4.5 lb.in	4.5 lb.in	0.4 Nm	
Approval						
Insulation Material / Material Group		Polyamide 6,6 / 1				
Rated Impulse Voltage / Pollution Degree		8 KV / 3				
		Type / Cat. No.	Standard Pack			
Terminal Block		CYG2.5	100			
End Plate 		EPCY2.5/10	50			
Partition Plate 		PPCY2.5/10	20			
Mounting Rail (Refer Pg. 263 for details) 		CA701-1M / CA701-1M-S	50 m			
		CA701-15-1M / CA701-15-1M-S	25 m			
End Clamp (Refer Pg. 264 for details) 		CA702 / CA802	50			
Test Plug		TX2.5	20			
Marking Tags (Refer Pg. 268 for details) 		CA509/K5WHT	100			
Marker Card (Refer Pg. 269 for details)		MC5	10			
Screw Driver 		SCS0.5/3	Blade size: 0.5 x 3.0 mm		10	
		Type / Cat. No.	Imax	Standard Pack		
Pluggable Jumpers 		2 pole	JX2.5/2	24 A	100	
		3 pole	JX2.5/3	24 A	50	
		4 pole	JX2.5/4	24 A	50	
		5 pole	JX2.5/5	24 A	50	
		6 pole	JX2.5/6	24 A	10	
		7 pole	JX2.5/7	24 A	10	
		8 pole	JX2.5/8	24 A	10	
		10 pole	JX2.5/10	24 A	10	
		16 pole				
		20 pole	JX2.5/20	24 A	10	
Step Down Jumpers		JYS6/2.5	24 A	20		
		JYS10/2.5	24 A	20		

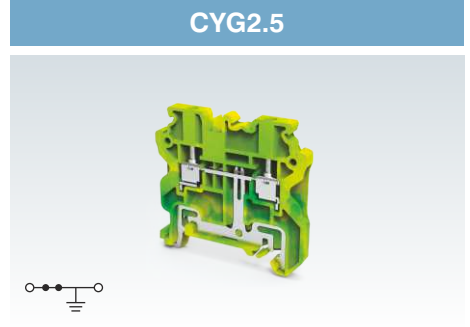

CYG4

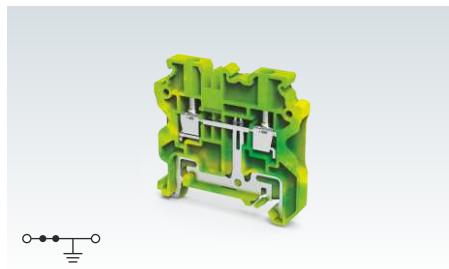

CYG6

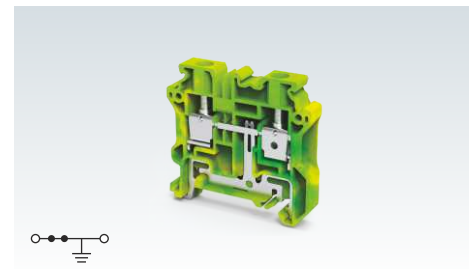

Width (Thickness) x Length	6 x 50 mm				8 x 50 mm			
Height with DIN 35 x 7.5 / 35 x 15 mm Rail	49 mm / 56.5 mm				49 mm / 56.5 mm			
Connection Possibility as per	IEC		UL - CSA		IEC		UL - CSA	
	With 1 Conductor per clamp	Stranded / Flexible	0.2 - 4.0 mm ²	24 - 10 AWG	0.2 - 6.0 mm ²	24 - 8 AWG	0.2 - 10.0 mm ²	24 - 8 AWG
		Solid with Ferrule / Lug	0.2 - 6.0 mm ²	24 - 12 AWG	0.2 - 4.0 mm ²	24 - 8 AWG	0.2 - 6.0 mm ²	24 - 8 AWG
With 2 same size Conductors per clamp	with TWIN Ferrule / Lug	0.5 - 2.5 mm ²	20 - 14 AWG	0.5 - 4.0 mm ²	20 - 12 AWG			
Wire Stripping Length	9 mm				10 mm			
Ratings As Per	IEC60947-7-2	UL-1059	CSA22.2-158	IEC60079-7	IEC60947-7-2	UL-1059	CSA22.2-158	IEC60079-7
Torque	0.5 Nm	4.5 lb.in	4.5 lb.in	0.5 Nm	0.8 Nm	11 lb.in	11 lb.in	0.8 Nm
Approval								
Insulation Material / Material Group	Polyamide 6,6 / 1				Polyamide 6,6 / 1			
Rated Impulse Voltage / Pollution Degree	8 KV / 3				8 KV / 3			

	Type / Cat. No.	Standard Pack	Type / Cat. No.	Standard Pack
Terminal Block	CYG4	100	CYG6	100
End Plate	EPCY2.5/10	50	EPCY2.5/10	50
Partition Plate	PPCY2.5/10	20	PPCY2.5/10	20
Mounting Rail (Refer Pg. 263 for details)	CA701-1M / CA701-1M-S	50 m	CA701-1M / CA701-1M-S	50 m
	CA701-15-1M / CA701-15-1M-S	25 m	CA701-15-1M / CA701-15-1M-S	25 m
End Clamp (Refer Pg. 264 for details)	CA702 / CA802	50	CA702 / CA802	50
Marking Tags (Refer Pg. 268 for details)	CA509/K6WHT	100	CA509/K8WHT	100
Marker Card (Refer Pg. 269 for details)	MC6	10	MC8	10
Screw Driver	SCS0.6/3.5 Blade size: 0.6 x 3.5 mm	10	SCS0.8/4 Blade size: 0.8 x 4 mm	10

	Type / Cat. No.	I _{max}	Standard Pack	Type / Cat. No.	I _{max}	Standard Pack
Pluggable Jumpers	2 pole JX4/2	32 A	100	JY6/2	35 A	100
	3 pole JX4/3	32 A	50	JY6/3	35 A	50
	4 pole JX4/4	32 A	50	JY6/4	35 A	50
	5 pole JX4/5	32 A	50	JY6/5	35 A	50
	6 pole JX4/6	32 A	50	JY6/6	35 A	10
	7 pole			JY6/7	35 A	10
	8 pole JX4/8	32 A	10	JY6/8	35 A	10
	10 pole JX4/10	32 A	10	JY6/10	35 A	10
	16 pole JX4/16	32 A	10			
	Step Down Jumpers				JYS6/2.5	24 A

CYG10

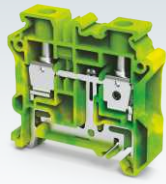

10 x 50 mm

49 mm / 56.5 mm

IEC UL - CSA

0.2 - 10.0 mm² 24 - 6 AWG

0.2 - 10.0 mm² 24 - 6 AWG

0.5 - 6.0 mm²

11 mm

IEC60947-7-2 UL-1059 CSA22.2-158 IEC60079-7

1.2 Nm 14 lb.in 14 lb.in 1.2 Nm



Polyamide 6,6 / 1

8 KV / 3

Type / Cat. No.	Standard Pack
CYG10	50
EPCY2.5/10	20
PPCY2.5/10	20
CA701-1M / CA701-1M-S	50 m
CA701-15-1M / CA701-15-1M-S	25 m
CA702 / CA802	50
CA509/K10WHT	100
MC10	10
SCS0.8/4 Blade size: 0.8 x 4 mm	10

Type / Cat. No.	I _{max}	Standard Pack
JY10/2	50 A	20
JYS10/2.5	24 A	20

CYG16

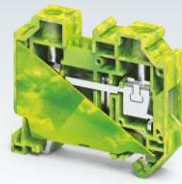

12 x 58.9 mm

50.8 mm / 51.2 mm

IEC UL - CSA

1.5 - 16.0 mm² 16 - 4 AWG

1.5 - 16.0 mm² 16 - 4 AWG

0.5 - 10.0 mm²

14 mm

IEC60947-7-2 UL-1059

2.5 Nm 14 lb.in



Polyamide 6,6 / 1

8 KV / 3







Type / Cat. No.	Standard Pack
CYG16	50
CA701-1M / CA701-1M-S	50 m
CA701-15-1M / CA701-15-1M-S	25 m
CA702 / CA802	50
CA509/K12WHT	100
MC12	10
SCS1.0/5.5 Blade size: 1.0 x 5.5 mm	10

Type / Cat. No.	I _{max}	Standard Pack
JY16/2	76 A	20

MULTIPLE CONNECTION TERMINAL BLOCKS

CY series multi connect 3 wire & 4 wire screw clamp Terminal Blocks are used to eliminate reliability problems encountered when there is a need to connect multiple wires in a single Terminal Block.

The terminals with  & IECEx approval can be used in potentially explosive atmosphere. For detailed information refer page 289.

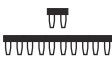
Width (Thickness) x Length		6 x 58.8 mm				
Height with DIN 35 x 7.5 / 35 x 15 mm Rail		50.7 mm / 58.2 mm				
Connection Possibility as per		IEC		UL - CSA		
With 1 Conductor per clamp	Stranded / Flexible	0.2 - 4.0 mm ²		24 - 10 AWG		
	Solid with Ferrule / Lug	0.2 - 6.0 mm ²		24 - 12 AWG		
With 2 same size Conductors per clamp	with TWIN Ferrule / Lug	0.5 - 2.5 mm ²		20 - 14 AWG		
Wire Stripping Length		9 mm				
Ratings As Per		IEC60947-7-1	UL-1059	CSA22.2-158	IEC60079-7	
Voltage		500 V	150 V	150 V	400 V	
Current		32 A	30 A	30 A	28 A	
Torque		0.5 Nm	4.5 lb.in	4.5 lb.in	0.5 Nm	
Approval						
Insulation Material / Material Group		Polyamide 6,6 / 1				
Rated Impulse Voltage / Pollution Degree		8 KV / 3				
		Type / Cat. No.	Standard Pack			
Terminal Block	Grey	CY4/3	50			
	Blue	CY4/3BU	50			
	Black	CY4/3BK	50			
	Red	CY4/3R	50			
	Ground / Earth	CYG4/3 (Refer Pg. 116 for details)	50			
End Plate		EPCY4/3	50			
Mounting Rail (Refer Pg. 263 for details)		CA701-1M / CA701-1M-S	50 m			
		CA701-15-1M / CA701-15-1M-S	25 m			
End Clamp (Refer Pg. 264 for details)		CA702 / CA802	50			
Marking Tags (Refer Pg. 268 for details)		CA509/K6WHT	100			
Marker Card (Refer Pg. 269 for details)		MC6	10			
Screw Driver		SCS0.6/3.5 Blade size: 0.6 x 3.5 mm	10			
Jumpers		Type / Cat. No.	I _{max}	Standard Pack		
Pluggable Jumpers		2 pole	JX4/2	32 A	100	
		3 pole	JX4/3	32 A	50	
		4 pole	JX4/4	32 A	50	
		5 pole	JX4/5	32 A	50	
		6 pole	JX4/6	32 A	50	
		7 pole				
		8 pole	JX4/8	32 A	10	
		10 pole	JX4/10	32 A	10	
16 pole	JX4/16	32 A	10			

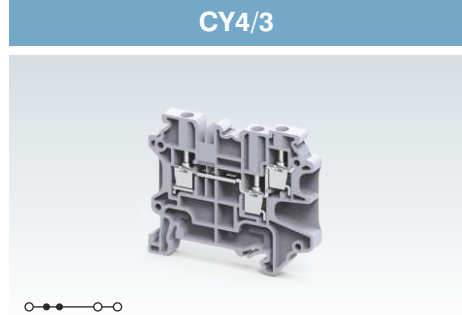

CY4/4

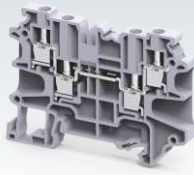

6 x 69.7 mm

50.7 mm / 58.2 mm

IEC	UL - CSA
0.2 - 4.0 mm ²	24 - 10 AWG
0.2 - 6.0 mm ²	
0.2 - 4.0 mm ²	24 - 12 AWG
0.5 - 2.5 mm ²	20 - 14 AWG

9 mm

IEC60947-7-1 UL-1059 CSA22.2-158 IEC60079-7

500 V	150 V	150 V	400 V
32 A	30 A	30 A	28 A
0.5 Nm	4.5 lb.in	4.5 lb.in	0.5 Nm



Polyamide 6,6 / 1

8 KV / 3

Type / Cat. No.	Standard Pack	
CY4/4	50	
CY4/4BU	50	
CY4/4 (Refer Pg. 116 for details)	50	
EPCY4/4	50	
CA701-1M / CA701-1M-S	50 m	
CA701-15-1M / CA701-15-1M-S	25 m	
CA702 / CA802	50	
CA509/K6WHT	100	
MC6	10	
SCS0.6/3.5 Blade size: 0.6 x 3.5 mm	10	
Type / Cat. No.	I _{max}	Standard Pack
JX4/2	32 A	100
JX4/3	32 A	50
JX4/4	32 A	50
JX4/5	32 A	50
JX4/6	32 A	50
JX4/8	32 A	10
JX4/10	32 A	10
JX4/16	32 A	10

CYG4/3

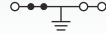
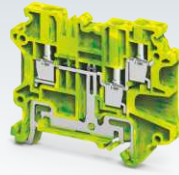

6 x 58.8 mm

50.7 mm / 58.2 mm

IEC	UL - CSA
0.2 - 4.0 mm ²	24 - 10 AWG
0.2 - 6.0 mm ²	
0.2 - 4.0 mm ²	24 - 12 AWG
0.5 - 2.5 mm ²	20 - 14 AWG

9 mm

IEC60947-7-2 UL-1059 CSA22.2-158 IEC60079-7

0.5 Nm	4.5 lb.in	4.5 lb.in	0.5 Nm
0.5 Nm	4.5 lb.in	4.5 lb.in	0.5 Nm



Polyamide 6,6 / 1

8 KV / 3

Type / Cat. No.	Standard Pack	
CYG4/3	50	
EPCY4/3	50	
CA701-1M / CA701-1M-S	50 m	
CA701-15-1M / CA701-15-1M-S	25 m	
CA702 / CA802	50	
CA509/K6WHT	100	
MC6	10	
SCS0.6/3.5 Blade size: 0.6 x 3.5 mm	10	
Type / Cat. No.	I _{max}	Standard Pack
JX4/2	32 A	100
JX4/3	32 A	50
JX4/4	32 A	50
JX4/5	32 A	50
JX4/6	32 A	50
JX4/8	32 A	10
JX4/10	32 A	10
JX4/16	32 A	10

CYG4/4

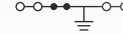
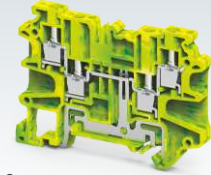

6 x 69.7 mm

50.7 mm / 58.2 mm

IEC	UL - CSA
0.2 - 4.0 mm ²	24 - 10 AWG
0.2 - 6.0 mm ²	
0.2 - 4.0 mm ²	24 - 12 AWG
0.5 - 2.5 mm ²	20 - 14 AWG

9 mm

IEC60947-7-2 UL-1059 CSA22.2-158 IEC60079-7

0.5 Nm	4.5 lb.in	4.5 lb.in	0.5 Nm
0.5 Nm	4.5 lb.in	4.5 lb.in	0.5 Nm



Polyamide 6,6 / 1

8 KV / 3

Type / Cat. No.	Standard Pack	
CYG4/4	50	
EPCY4/4	50	
CA701-1M / CA701-1M-S	50 m	
CA701-15-1M / CA701-15-1M-S	25 m	
CA702 / CA802	50	
CA509/K6WHT	100	
MC6	10	
SCS0.6/3.5 Blade size: 0.6 x 3.5 mm	10	
Type / Cat. No.	I _{max}	Standard Pack
JX4/2	32 A	100
JX4/3	32 A	50
JX4/4	32 A	50
JX4/5	32 A	50
JX4/6	32 A	50
JX4/8	32 A	10
JX4/10	32 A	10
JX4/16	32 A	10

MULTIPLE LEVEL TERMINAL BLOCKS

CYDL2.5 is the next generation compact double level Screw Clamp Terminal Block. This Terminal Block is used in high density wiring applications.

Jumpering is possible at both levels. This Terminal Block is suitable for 1000 V rating.

CYDL2.5(I.S) is double level internally shorted screw clamp Terminal Block. This is an ideal choice for distribution application.







CYDLG2.5 is double level Terminal Block with a grounding point for terminating grounding cables on the lower level of the terminal block while the top level is a standard feed through terminal. The earth connection is made by snapping the terminal on the Din rail. This separate connection point is appropriately identified by the green-yellow imprint on its top.

CYDLG2.5(I.S) is double level ground Terminal Block with 4 connection points for grounding wires. It is available in a standard green yellow colour to indicate the grounding connection.

The terminals with  & IECEx approval can be used in potentially explosive atmosphere. For detailed information refer page 289.

CYDL2.5



Width (Thickness) x Length	5 x 70.5 mm				
Height with DIN 35 x 7.5 / 35 x 15 mm Rail	65.9 mm / 73.4 mm				
Connection Possibility as per	IEC		UL - CSA		
With 1 Conductor per clamp	Stranded / Flexible	0.2 - 2.5 mm ²	24 - 12 AWG		
	Solid	0.2 - 4.0 mm ²	24 - 10 AWG		
	with Ferrule / Lug	0.2 - 2.5 mm ²	24 - 12 AWG		
With 2 same size Conductors per clamp	with TWIN Ferrule / Lug	0.5 - 1.5 mm ²	20 - 16 AWG		
Wire Stripping Length	8 mm				
Ratings As Per	IEC60947-7-1	UL-1059	CSA22.2-158	IEC60079-7	
Voltage	500 V	300 V	300 V	630 V	
Current	24 A	20 A	20 A	21 A	
Torque	0.4 Nm	3.6 lb.in	3.6 lb.in	0.4 Nm	
Approval					
Insulation Material / Material Group	Polyamide 6,6 / 1				
Rated Impulse Voltage / Pollution Degree	8 KV / 3				
	Type / Cat. No.		Standard Pack		
Terminal Block	Grey	CYDL2.5	50		
	Blue	CYDL2.5BU	50		
	Ground / Earth	CYDLG2.5(I.S) (Refer Pg. 118 for details)	50		
End Plate		EPCYDL2.5/4	50		
Mounting Rail (Refer Pg. 263 for details)		CA701-1M / CA701-1M-S	50 m		
		CA701-15-1M / CA701-15-1M-S	25 m		
End Clamp (Refer Pg. 264 for details)		CA702 / CA802	50		
Test Plug		TX2.5	20		
Marking Tags (Refer Pg. 268 for details)		CA509/K5WHT	100		
Marker Card (Refer Pg. 269 for details)		MC5	10		
Screw Driver		SCS0.5/3	Blade size: 0.5 x 3.0 mm	10	
	Type / Cat. No.		Imax	Standard Pack	
Pluggable Jumpers		2 pole	JX2.5/2	24 A	100
		3 pole	JX2.5/3	24 A	50
		4 pole	JX2.5/4	24 A	50
		5 pole	JX2.5/5	24 A	50
		6 pole	JX2.5/6	24 A	10
		7 pole	JX2.5/7	24 A	10
		8 pole	JX2.5/8	24 A	10
		10 pole	JX2.5/10	24 A	10
		20 pole	JX2.5/20	24 A	10

CYDL2.5(I.S)



5 x 70.5 mm

65.9 mm / 73.4 mm

IEC	UL - CSA
0.2 - 2.5 mm ²	24 - 12 AWG
0.2 - 4.0 mm ²	24 - 10 AWG
0.2 - 2.5 mm ²	24 - 12 AWG

0.5 - 1.5 mm² 20 - 16 AWG

8 mm

IEC60947-7-1 UL-1059 CSA22.2-158 IEC60079-7

500 V	300 V	300 V	630 V
24 A	20 A	20 A	21 A
0.4 Nm	3.6 lb.in	3.6 lb.in	0.4 Nm



Polyamide 6,6 / 1

8 KV / 3

Type / Cat. No.	Standard Pack
CYDL2.5(I.S)	50

EPCYDL2.5/4	50
CA701-1M / CA701-1M-S	50 m
CA701-15-1M / CA701-15-1M-S	25 m
CA702 / CA802	50
TX2.5	20
CA509/K5WHT	100
MC5	10
SCS0.5/3 Blade size: 0.5 x 3.0 mm	10

Type / Cat. No.	I _{max}	Standard Pack
JX2.5/2	24 A	100
JX2.5/3	24 A	50
JX2.5/4	24 A	50
JX2.5/5	24 A	50
JX2.5/6	24 A	10
JX2.5/7	24 A	10
JX2.5/8	24 A	10
JX2.5/10	24 A	10
JX2.5/20	24 A	10

CYDLG2.5



5 x 70.5 mm

65.9 mm / 73.4 mm

IEC	UL - CSA
0.2 - 2.5 mm ²	24 - 12 AWG
0.2 - 4.0 mm ²	24 - 10 AWG
0.2 - 2.5 mm ²	24 - 12 AWG

0.5 - 1.5 mm² 20 - 16 AWG

8 mm

IEC60947-7-1 UL-1059 CSA22.2-158

500 V	300 V	300 V
Top Level - 24 A	Top Level - 20 A	Top Level - 20 A
0.4 Nm	3.6 lb.in	3.6 lb.in



Polyamide 6,6 / 1

8 KV / 3

Type / Cat. No.	Standard Pack
CYDLG2.5	50

EPCYDL2.5/4	50
CA701-1M / CA701-1M-S	50 m
CA701-15-1M / CA701-15-1M-S	25 m
CA702 / CA802	50
TX2.5	20
CA509/K5WHT	100
MC5	10
SCS0.5/3 Blade size: 0.5 x 3.0 mm	10

Type / Cat. No.	I _{max}	Standard Pack
JX2.5/2	24 A	100
JX2.5/3	24 A	50
JX2.5/4	24 A	50
JX2.5/5	24 A	50
JX2.5/6	24 A	10
JX2.5/7	24 A	10
JX2.5/8	24 A	10
JX2.5/10	24 A	10
JX2.5/20	24 A	10

CYDLG2.5(I.S)

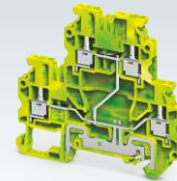

5 x 70.5 mm

65.9 mm / 73.4 mm

IEC	UL - CSA
0.2 - 2.5 mm ²	24 - 12 AWG
0.2 - 4.0 mm ²	24 - 10 AWG
0.2 - 2.5 mm ²	24 - 12 AWG

0.5 - 1.5 mm² 20 - 16 AWG

8 mm

IEC60947-7-2 UL-1059 CSA22.2-158 IEC60079-7

500 V	300 V	300 V	630 V
24 A	20 A	20 A	21 A
0.4 Nm	3.6 lb.in	3.6 lb.in	0.4 Nm



Polyamide 6,6 / 1

8 KV / 3

Type / Cat. No.	Standard Pack
CYDLG2.5(I.S)	50

EPCYDL2.5/4	50
CA701-1M / CA701-1M-S	50 m
CA701-15-1M / CA701-15-1M-S	25 m
CA702 / CA802	50
TX2.5	20
CA509/K5WHT	100
MC5	10
SCS0.5/3 Blade size: 0.5 x 3.0 mm	10

Type / Cat. No.	I _{max}	Standard Pack
JX2.5/2	24 A	100
JX2.5/3	24 A	50
JX2.5/4	24 A	50
JX2.5/5	24 A	50
JX2.5/6	24 A	10
JX2.5/7	24 A	10
JX2.5/8	24 A	10
JX2.5/10	24 A	10
JX2.5/20	24 A	10

MULTIPLE LEVEL TERMINAL BLOCKS

CYDL4 is the next generation compact double level Screw Clamp Terminal Block. This Terminal Block is used in high density wiring applications.

Interconnections / shorting is possible at both levels. This Terminal Block is suitable for 1000 V rating.

CYDL4(I.S) is double level internally shorted screw clamp Terminal Block. This is an ideal choice for distribution application.

CYDLG4 is double level Terminal Block with a grounding point for terminating grounding cables on the lower level of the terminal block while the top level is a standard feed through terminal. The earth connection is made by snapping the terminal on the Din rail. This separate connection point is appropriately identified by the green-yellow imprint on its top.

CYDLG4(I.S) is double level ground Terminal Block with 4 connection points for grounding wires. It is available in a standard green yellow colour to indicate the grounding connection.

The terminals with  & IECEx approval can be used in potentially explosive atmosphere. For detailed information refer page 289.

CYDL4

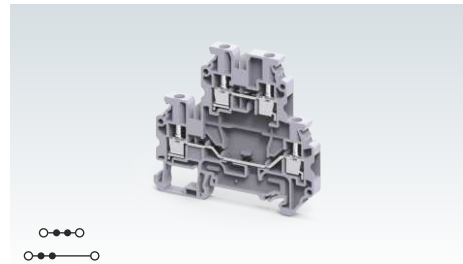

Width (Thickness) x Length	6 x 70.5 mm			
Height with DIN 35 x 7.5 / 35 x 15 mm Rail	65.9 mm / 73.4 mm			
Connection Possibility as per	IEC		UL - CSA	
With 1 Conductor per clamp	Stranded / Flexible	0.2 - 4.0 mm ²	24 - 10 AWG	
	Solid with Ferrule / Lug	0.2 - 6.0 mm ²	24 - 12 AWG	
With 2 same size Conductors per clamp	with TWIN Ferrule / Lug	0.2 - 4.0 mm ²	24 - 12 AWG	
With 2 same size Conductors per clamp	with TWIN Ferrule / Lug	0.5 - 2.5 mm ²	20 - 14 AWG	
Wire Stripping Length	9 mm			
Ratings As Per	IEC60947-7-1	UL-1059	CSA22.2-158	IEC60079-7
Voltage	800 V	300 V	300 V	500 V
Current	32 A	30 A	30 A	28 A
Torque	0.5 Nm	4.5 lb.in	4.5 lb.in	0.5 Nm
Approval				
Insulation Material / Material Group	Polyamide 6,6 / 1			
Rated Impulse Voltage / Pollution Degree	8 KV / 3			

	Type / Cat. No.	Standard Pack	
Terminal Block	Grey	CYDL4	50
	Blue	CYDL4BU	50
	Red	CYDL4R	50
	Black	CYDL4BK	50
	Green	CYDL4GN	50
	Ground / Earth	CYDLG4(I.S.) (Refer Pg. 120 for details)	50
End Plate	EPCYDL2.5/4	50	
Partition Plate	PPCYDL2.5/4	20	
Mounting Rail (Refer Pg. 263 for details)	CA701-1M / CA701-1M-S	50 m	
	CA701-15-1M / CA701-15-1M-S	25 m	
End Clamp (Refer Pg. 264 for details)	CA702 / CA802	50	
Marking Tags (Refer Pg. 268 for details)	CA509/K6WHT	100	
Marker Card (Refer Pg. 269 for details)	MC6	10	
Screw Driver	SCS0.6/3.5 Blade size: 0.6 x 3.5 mm	10	

	Type / Cat. No.	I _{max}	Standard Pack	
Pluggable Jumpers	2 pole	JX4/2	32 A	100
	3 pole	JX4/3	32 A	50
	4 pole	JX4/4	32 A	50
	5 pole	JX4/5	32 A	50
	6 pole	JX4/6	32 A	50
	7 pole			
	8 pole	JX4/8	32 A	10
	10 pole	JX4/10	32 A	10
	16 pole	JX4/16	32 A	10

CYDL4(I.S)



6 x 70.5 mm

65.9 mm / 73.4 mm

IEC	UL - CSA
0.2 - 4.0 mm ²	24 - 10 AWG
0.2 - 6.0 mm ²	
0.2 - 4.0 mm ²	24 - 12 AWG
0.5 - 2.5 mm ²	20 - 14 AWG

9 mm

IEC60947-7-1 UL-1059 CSA22.2-158 IEC60079-7

800 V	300 V	300 V	500 V
32 A	30 A	30 A	28 A
0.5 Nm	4.5 lb.in	4.5 lb.in	0.5 Nm



Polyamide 6,6 / 1

8 KV / 3

Type / Cat. No.	Standard Pack
CYDL4(I.S)	50

EPCYDL2.5/4	50
PPCYDL2.5/4	20
CA701-1M / CA701-1M-S	50 m
CA701-15-1M / CA701-15-1M-S	25 m
CA702 / CA802	50
CA509/K6WHT	100
MC6	10
SCS0.6/3.5 Blade size: 0.6 x 3.5 mm	10

Type / Cat. No.	I _{max}	Standard Pack
JX4/2	32 A	100
JX4/3	32 A	50
JX4/4	32 A	50
JX4/5	32 A	50
JX4/6	32 A	50
JX4/8	32 A	10
JX4/10	32 A	10
JX4/16	32 A	10

CYDLG4



6 x 70.5 mm

65.9 mm / 73.4 mm

IEC	UL - CSA
0.2 - 4.0 mm ²	24 - 10 AWG
0.2 - 6.0 mm ²	
0.2 - 4.0 mm ²	24 - 12 AWG
0.5 - 2.5 mm ²	20 - 14 AWG

9 mm

IEC60947-7-1 UL-1059 CSA22.2-158

800 V	300 V	300 V
Top Level - 32 A	Top Level - 30 A	Top Level - 30 A
0.5 Nm	4.5 lb.in	4.5 lb.in



Polyamide 6,6 / 1

8 KV / 3

Type / Cat. No.	Standard Pack
CYDLG4	50

EPCYDL2.5/4	50
PPCYDL2.5/4	20
CA701-1M / CA701-1M-S	50 m
CA701-15-1M / CA701-15-1M-S	25 m
CA702 / CA802	50
CA509/K6WHT	100
MC6	10
SCS0.6/3.5 Blade size: 0.6 x 3.5 mm	10

Type / Cat. No.	I _{max}	Standard Pack
JX4/2	32 A	100
JX4/3	32 A	50
JX4/4	32 A	50
JX4/5	32 A	50
JX4/6	32 A	50
JX4/8	32 A	10
JX4/10	32 A	10
JX4/16	32 A	10

CYDLG4(I.S)

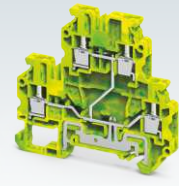

6 x 70.5 mm

65.9 mm / 73.4 mm

IEC	UL - CSA
0.2 - 4.0 mm ²	24 - 10 AWG
0.2 - 6.0 mm ²	
0.2 - 4.0 mm ²	24 - 12 AWG
0.5 - 2.5 mm ²	20 - 14 AWG

9 mm

IEC60947-7-2 UL-1059 CSA22.2-158 IEC60079-7

800 V	300 V	300 V	500 V
32 A	30 A	30 A	28 A
0.5 Nm	4.5 lb.in	4.5 lb.in	0.5 Nm



Polyamide 6,6 / 1

8 KV / 3

Type / Cat. No.	Standard Pack
CYDLG4(I.S)	50

EPCYDL2.5/4	50
PPCYDL2.5/4	20
CA701-1M / CA701-1M-S	50 m
CA701-15-1M / CA701-15-1M-S	25 m
CA702 / CA802	50
CA509/K6WHT	100
MC6	10
SCS0.6/3.5 Blade size: 0.6 x 3.5 mm	10

Type / Cat. No.	I _{max}	Standard Pack
JX4/2	32 A	100
JX4/3	32 A	50
JX4/4	32 A	50
JX4/5	32 A	50
JX4/6	32 A	50
JX4/8	32 A	10
JX4/10	32 A	10
JX4/16	32 A	10

FUSE TERMINAL BLOCKS

These Terminal Blocks are used in electrical and control systems which require fuse protection.

CYF4 series fuse terminals have a thickness of 6 mm with a provision for using pluggable Jumpers. These Terminal Blocks are completely closed type and do not need separate end plate.

Alternate CYF4 terminals with CYK2.5N can be shorted with help of JX2.5 pluggable jumpers.

CYDLF4 terminal has an additional feed through connection level.

CYDLGF4 terminal has a feed through connection level along with ground connection point in addition to a standard hinged fuse carrier.

CYDL4FT terminal has a feed through system on both levels.

CYDLGF4FT has two feed through levels and an additional ground connection point.

CYDLF4LR is modified version of CYDLF4 where two equi-potential connection joints are available on both side of the Terminal Block.

CYTLF2.5 is a Triple Level Terminal Block with top level fuse connection and bottom two levels with feed through connection.

CYTLGF2.5 is a Triple Level Terminal Block with top level fuse connection, bottom two levels with feed through connection with additional ground connection point.

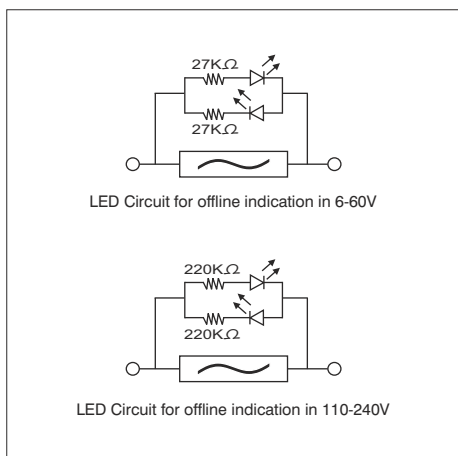

CYF4

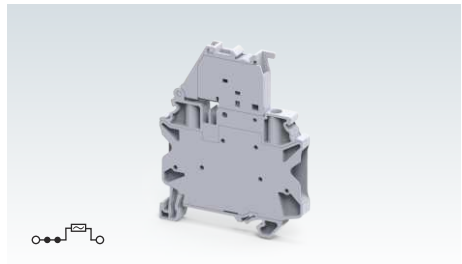

Width (Thickness) x Length	6 x 58.8 mm		
Height with DIN 35 x 7.5 / 35 x 15 / 32 mm Rail	72.4 mm / 79.9 mm		
Connection Possibility as per	IEC	UL - CSA	
With 1 Conductor per clamp	Stranded / Flexible	0.2 - 4.0 mm ²	24 - 10 AWG
	Solid with Ferrule / Lug	0.2 - 6.0 mm ²	
With 2 same size Conductors per clamp	Stranded / Flexible	0.2 - 4.0 mm ²	24 - 12 AWG
	with TWIN Ferrule / Lug	0.2 - 1.5 mm ²	24 - 16 AWG
		0.5 - 2.5 mm ²	20 - 14 AWG
Wire Stripping Length	9 mm		
Ratings As Per	IEC60947-7-3	UL-1059	CSA22.2-158
Voltage	1000 V	600 V	600 V
Current	10 A	10 A	10 A
Fuse Level Feed Through Level			
Torque	0.5 Nm	4.5 lb-in	4.5 lb-in
Approvals			
Insulation Material / Material Group	Polyamide 6,6 / 1		
Rated Impulse Voltage / Pollution Degree	6 kV / 3		
Fuse Size	Ø5 x 20 mm		

Type / Cat. No.	Standard Pack
CYF4	50
CYF4BU	50
CYF4BK	50
CYF4L6-60V	50
CYF4L10-36V	50
CYF4L110-240V	50
CA701-1M / CA701-1M-S	50 m
CA701-15-1M / CA701-15-1M-S	25 m
CA702 / CA802	50
CA509/K6WHT	100
MC6	10
SCS0.6/3.5 Blade size: 0.6 x 3.5 mm	10

Type / Cat. No.	I _{max}	Standard Pack
JX4/2	32 A	100
JX4/3	32 A	50
JX4/4	32 A	50
JX4/5	32 A	50
JX4/6	32 A	50
JX4/8	32 A	10
JX4/10	32 A	10
JX4/16	32 A	10
JX2.5/11/2	24 A	10
JX2.5/11/8	24 A	10

CYDLF4

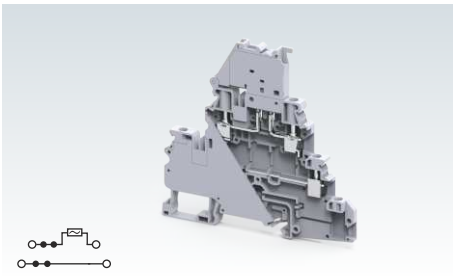

6 x 94.5 mm
90.9 mm / 98.4 mm

IEC	UL - CSA
0.2 - 4.0 mm ²	24 - 10 AWG
0.2 - 6.0 mm ²	
0.2 - 4.0 mm ²	24 - 12 AWG
0.2 - 1.5 mm ²	24 - 16 AWG
0.5 - 2.5 mm ²	20 - 14 AWG

9 mm

IEC60947-7-3 UL-1059 CSA22.2-158

500 V	300 V	300 V
10 A	10 A	10 A
32 A	30 A	30 A

0.5 Nm	4.5 lb-in	4.5 lb-in



Polyamide 6,6 / 1

6 KV / 3

Ø5 x 20 mm

Type / Cat. No.	Standard Pack
CYDLF4	50
CYDLF4L6-60V	50
CYDLF4L110-240V	50
CYDLF4FT	50
CYDLGF4FT	50
CA701-1M / CA701-1M-S	50 m
CA701-15-1M / CA701-15-1M-S	25 m
CA702 / CA802 / CA202	50
CA509/K6WHT	100
MC6	10
SCS0.6/3.5 Blade size: 0.6 x 3.5 mm	10

Type / Cat. No.	I _{max}	Standard Pack
JX4/2	32 A	100
JX4/3	32 A	50
JX4/4	32 A	50
JX4/5	32 A	50
JX4/6	32 A	50
JX4/8	32 A	10
JX4/10	32 A	10
JX4/16	32 A	10

CYDLGF4

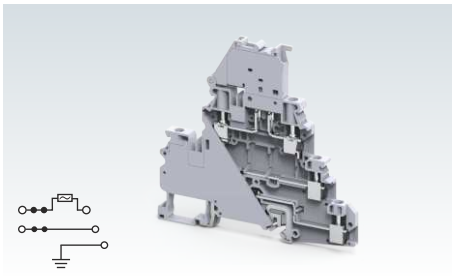

6 x 94.5 mm
90.9 mm / 98.4 mm

IEC	UL - CSA
0.2 - 4.0 mm ²	24 - 10 AWG
0.2 - 6.0 mm ²	
0.2 - 4.0 mm ²	24 - 12 AWG
0.2 - 1.5 mm ²	24 - 16 AWG
0.5 - 2.5 mm ²	20 - 14 AWG

9 mm

IEC60947-7-3 UL-1059 CSA22.2-158

500 V	300 V	300 V
10 A	10 A	10 A
32 A	30 A	30 A

0.5 Nm	4.5 lb-in	4.5 lb-in



Polyamide 6,6 / 1

6 KV / 3

Ø5 x 20 mm

Type / Cat. No.	Standard Pack
CYDLGF4	50
CYDLGF4L6-60V	50
CYDLGF4L110-240V	50
CYDLGF4FT	50
CYDLGF4FT	50
CA701-1M / CA701-1M-S	50 m
CA701-15-1M / CA701-15-1M-S	25 m
CA702 / CA802 / CA202	50
CA509/K6WHT	100
MC6	10
SCS0.6/3.5 Blade size: 0.6 x 3.5 mm	10

Type / Cat. No.	I _{max}	Standard Pack
JX4/2	32 A	100
JX4/3	32 A	50
JX4/4	32 A	50
JX4/5	32 A	50
JX4/6	32 A	50
JX4/8	32 A	10
JX4/10	32 A	10
JX4/16	32 A	10

CYDLF4LR

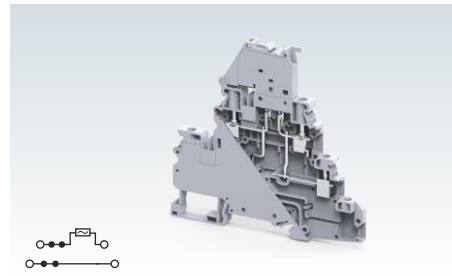

6 x 94.5 mm
90.9 mm / 98.4 mm

IEC	UL - CSA
0.2 - 4.0 mm ²	24 - 10 AWG
0.2 - 6.0 mm ²	
0.2 - 4.0 mm ²	24 - 12 AWG
0.2 - 1.5 mm ²	24 - 16 AWG
0.5 - 2.5 mm ²	24 - 14 AWG

9 mm

IEC60947-7-1 UL-1059 CSA22.2-158

630 V	300 V	300 V
10 A	10 A	10 A

0.5 Nm	4.5 lb-in	4.5 lb-in



Polyamide 6,6 / 1

6 KV / 3

Ø5 x 20 mm

Type / Cat. No.	Standard Pack
CYDLF4LR	50
CYDLGF4LR	50
CYDLF4LRL6-60V	50
CYDLF4LRL110-240V	50
CA701-1M / CA701-1M-S	50 m
CA701-15-1M / CA701-15-1M-S	25 m
CA702 / CA802 / CA202	50
CA509/K6WHT	100
MC6	10
SCS0.6/3.5 Blade size: 0.6 x 3.5 mm	10

Type / Cat. No.	I _{max}	Standard Pack
JX4/2	32 A	100
JX4/3	32 A	50
JX4/4	32 A	50
JX4/5	32 A	50
JX4/6	32 A	50
JX4/8	32 A	10
JX4/10	32 A	10
JX4/16	32 A	10

FUSE TERMINAL BLOCKS

CYDLF4FT

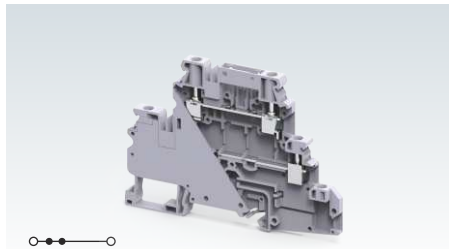

CYDLGF4FT

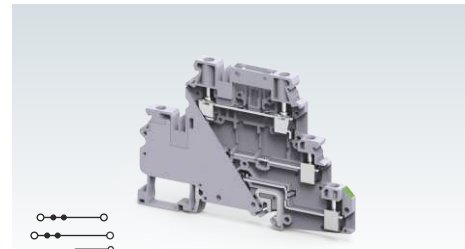

Width (Thickness) x Length	6 x 94.5 mm			6 x 94.5 mm			
Height with DIN 35 x 7.5 / 35 x 15 / 32 mm Rail	67.6 mm / 75.1 mm			67.6 mm / 75.1 mm			
Connection Possibility as per	IEC	UL - CSA		IEC	UL - CSA		
	With 1 Conductor per clamp	Stranded / Flexible Solid	0.2 - 4.0 mm ² 0.2 - 6.0 mm ²	24 - 10 AWG	0.2 - 4.0 mm ² 0.2 - 6.0 mm ²	24 - 10 AWG	
With 2 same size Conductors per clamp	Stranded / Flexible with TWIN Ferrule / Lug	0.2 - 4.0 mm ²	24 - 12 AWG	0.2 - 4.0 mm ²	24 - 12 AWG		
	Stranded / Flexible with TWIN Ferrule / Lug	0.2 - 1.5 mm ² 0.5 - 2.5 mm ²	24 - 16 AWG 20 - 14 AWG	0.2 - 1.5 mm ² 0.5 - 2.5 mm ²	24 - 16 AWG 20 - 14 AWG		
Wire Stripping Length	9 mm			9 mm			
Ratings As Per	IEC60947-7-1	UL-1059	CSA22.2-158	IEC60947-7-1	UL-1059	CSA22.2-158	
Voltage	500 V	300 V	300 V	500 V	300 V	300 V	
Current	32 A	30 A	30 A	32 A	30 A	30 A	
Torque	0.5 Nm	4.5 lb-in	4.5 lb-in	0.5 Nm	4.5 lb-in	4.5 lb-in	
Approvals							
Insulation Material / Material Group	Polyamide 6,6 / 1			Polyamide 6,6 / 1			
Rated Impulse Voltage / Pollution Degree	6 KV / 3			6 KV / 3			
	Type / Cat. No.		Standard Pack	Type / Cat. No.		Standard Pack	
Terminal Block	CYDLF4FT		50	CYDLGF4FT		50	
Mounting Rail (Refer Pg. 263 for details)	CA701-1M / CA701-1M-S		50 m	CA701-1M / CA701-1M-S		50 m	
	CA701-15-1M / CA701-15-1M-S		25 m	CA701-15-1M / CA701-15-1M-S		25 m	
End Clamp (Refer Pg. 264 for details)	CA702 / CA802 / CA202		50	CA702 / CA802 / CA202		50	
Marking Tags (Refer Pg. 268 for details)	CA509/K6WHT		100	CA509/K6WHT		100	
Marker Card (Refer Pg. 269 for details)	MC6		10	MC6		10	
Screw Driver	SCS0.6/3.5 Blade size: 0.6 x 3.5 mm		10	SCS0.6/3.5 Blade size: 0.6 x 3.5 mm		10	
	Type / Cat. No.	Imax	Standard Pack	Type / Cat. No.	Imax	Standard Pack	
Pluggable Jumpers	2 pole	JX4/2	32 A	100	JX4/2	32 A	100
	3 pole	JX4/3	32 A	50	JX4/3	32 A	50
	4 pole	JX4/4	32 A	50	JX4/4	32 A	50
	5 pole	JX4/5	32 A	50	JX4/5	32 A	50
	6 pole	JX4/6	32 A	50	JX4/6	32 A	50
	7 pole						
	8 pole	JX4/8	32 A	10	JX4/8	32 A	10
	10 pole	JX4/10	32 A	10	JX4/10	32 A	10
16 pole	JX4/16	32 A	10	JX4/16	32 A	10	

FUSE TERMINAL BLOCKS

CYTLF2.5

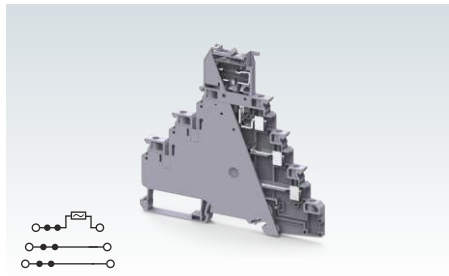

CYTLGF2.5

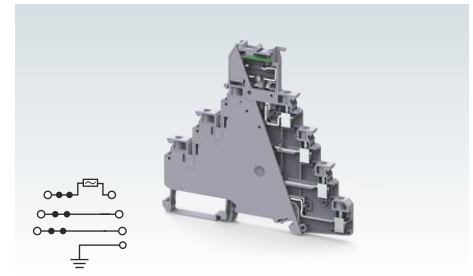

Width (Thickness) x Length	6 x 105.1 mm		6 x 105.1 mm	
Height with DIN 35 x 7.5 / 35 x 15 / 32 mm Rail	100 mm / 107.5 mm		100 mm / 107.5 mm	
Connection Possibility as per	IEC	UL - CSA	IEC	UL - CSA
With 1 Conductor per clamp	Stranded / Flexible	0.2 - 2.5 mm ²	24 - 14 AWG	0.2 - 2.5 mm ²
	Solid	0.2 - 4.0 mm ²	24 - 12 AWG	0.2 - 4.0 mm ²
	with Ferrule / Lug	0.2 - 2.5 mm ²	24 - 14 AWG	0.2 - 2.5 mm ²
With 2 same size Conductors per clamp	Stranded / Flexible with TWIN Ferrule / Lug	0.5 - 1.5 mm ²	20 - 16 AWG	0.5 - 1.5 mm ²
Wire Stripping Length	8 mm		8 mm	
Ratings As Per	IEC60947-7-3	UL-1059	IEC60947-7-3	UL-1059
Voltage	250 V	300 V	250 V	300 V
Current	Fuse Level	10 A	10 A	10 A
	Feed Through Level	20 A	20 A	20 A
Torque	0.4 Nm	4.5 lb-in	0.4 Nm	4.5 lb-in
Approvals				
Insulation Material / Material Group	Polyamide 6,6 / 1		Polyamide 6,6 / 1	
Rated Impulse Voltage / Pollution Degree	6 KV / 3		6 KV / 3	
Fuse Size	Ø5 x 20 mm		Ø5 x 20 mm	

	Type / Cat. No.	Standard Pack	Type / Cat. No.	Standard Pack
Terminal Block	Grey	CYTLF2.5	50	CYTLGF2.5
	Fuse, Feed Through & Ground Variant	CYTLF2.5FT, CYTLF2.5FT(L.S)	50	CYTLGF2.5FT
	With LED for 6 - 60 V AC/DC	CYTLF2.5L6-60V	50	CYTLGF2.5L6-60V
	With LED for 110 - 240 V AC/DC	CYTLF2.5110-240V	50	CYTLGF2.5110-240V
Mounting Rail (Refer Pg. 263 for details)		CA701-1M / CA701-1M-S	50 m	CA701-1M / CA701-1M-S
		CA701-15-1M / CA701-15-1M-S	25 m	CA701-15-1M / CA701-15-1M-S
End Clamp (Refer Pg. 264 for details)		CA702 / CA802 / CA202	50	CA702 / CA802 / CA202
Marking Tags (Refer Pg. 268 for details)		CA509/K6WHT	100	CA509/K6WHT
Marker Card (Refer Pg. 269 for details)		MC6	10	MC6
Screw Driver		SCS0.6/3.5 Blade size: 0.6 x 3.5 mm	10	SCS0.6/3.5 Blade size: 0.6 x 3.5 mm

	Type / Cat. No.	I _{max}	Standard Pack	Type / Cat. No.	I _{max}	Standard Pack
Pluggable Jumpers		2 pole	JX4/2	32 A	100	JX4/2
		3 pole	JX4/3	32 A	50	JX4/3
		4 pole	JX4/4	32 A	50	JX4/4
		5 pole	JX4/5	32 A	50	JX4/5
		6 pole	JX4/6	32 A	50	JX4/6
		7 pole				
		8 pole	JX4/8	32 A	10	JX4/8
		10 pole	JX4/10	32 A	10	JX4/10
		16 pole	JX4/16	32 A	10	JX4/16

DISCONNECT & TEST TERMINAL BLOCKS

These blocks are used for measuring, control and regulatory circuits.

CYK2.5, CYK2.5N, CYK4 disconnect terminals, disconnection is achieved by lifting a lever which operates the knife contact.

Alternate CYK2.5N with CYF4 can be shorted with the help of pluggable jumpers.

Specially designed socket headed screws act as test monitoring points in these Terminal Blocks.

Standard JX series push in jumpers can be used for interconnection.

CYK2.5NFT is a feed through terminal with same profile as that of CYK2.5N Disconnect Terminal Block.

CYDLK4 terminal is a double level disconnect Terminal Block with knife contact disconnect function at the top level and a feed through at the bottom level.

In the CYDLGK4 terminal, a grounding wire connection point is available in addition to the feed through and disconnect functionality.

CYK2.5

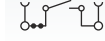
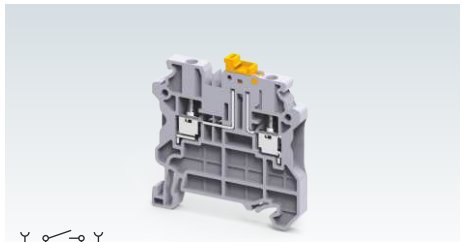

Width (Thickness) x Length	5 x 50 mm		
Height with DIN 35 x 7.5 / 35 x 15	53.2 mm / 60.7 mm		
Connection Possibility as per	IEC	UL - CSA	
With 1 Conductor per clamp	Stranded / Flexible	24 - 14 AWG	
	Solid	24 - 12 AWG	
	with Ferrule / Lug	24 - 14 AWG	
With 2 same size Conductors per clamp	Stranded / Flexible	24 - 16 AWG	
	with TWIN Ferrule / Lug		
Wire Stripping Length	8 mm		
Ratings As Per	IEC60947-7-1	UL-1059	
Voltage	500 V	300 V	
Current	20 A	16 A	
Torque	0.4 Nm	4.5 lb-in	
Approvals			
Insulation Material / Material Group	Polyamide 6,6 / 1		
Rated Impulse Voltage / Pollution Degree	6 KV / 3		
	Type / Cat. No.	Standard Pack	
Terminal Block	CYK2.5	50	

Mounting Rail	(Refer Pg. 263 for details)		CA701-1M / CA701-1M-S	50 m
			CA701-15-1M / CA701-15-1M-S	25 m
End Clamp	(Refer Pg. 264 for details)		CA702 / CA802	50
Marking Tags	(Refer Pg. 268 for details)		CA509/K5WHT	100
Marker Card	(Refer Pg. 269 for details)		MC5	10
Screw Driver			SCS0.5/3.0	Blade size: 0.5 x 3.0 mm

Jumpers		Type / Cat. No.	I _{max}	Standard Pack
Pluggable Jumpers		JX2.5/2	24 A	100
		JX2.5/3	24 A	50
		JX2.5/4	24 A	50
		JX2.5/5	24 A	50
		JX2.5/6	24 A	10
		JX2.5/7	24 A	10
		JX2.5/8	24 A	10
		JX2.5/10	24 A	10
		JX2.5/20	24 A	10
		Alternate Jumpers		JX2.5/11/2
JX2.5/11/8	24 A			10

CYK2.5N

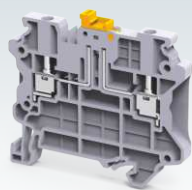

5 x 58.8 mm

53.2 mm / 60.7 mm

IEC	UL - CSA
0.2 - 2.5 mm ²	24 - 14 AWG
0.2 - 4.0 mm ²	24 - 12 AWG
0.2 - 2.5 mm ²	24 - 14 AWG

0.5 - 1.5 mm ²	24 - 16 AWG
---------------------------	-------------

8 mm

IEC60947-7-1 UL-1059

500 V	300 V		
20 A	16 A		
0.4 Nm	4.5 lb-in		



Polyamide 6,6 / 1

6 KV / 3

Type / Cat. No.	Standard Pack
CYK2.5N	50

CA701-1M / CA701-1M-S	50 m
CA701-15-1M / CA701-15-1M-S	25 m
CA702 / CA802	50
CA509/K5WHT	100
MC5	10
SCS0.5/3.0 Blade size: 0.5 x 3.0 mm	10

Type / Cat. No.	I _{max}	Standard Pack
JX2.5/2	24 A	100
JX2.5/3	24 A	50
JX2.5/4	24 A	50
JX2.5/5	24 A	50
JX2.5/6	24 A	10
JX2.5/7	24 A	10
JX2.5/8	24 A	10
JX2.5/10	24 A	10
JX2.5/20	24 A	10
JX2.5/11/2	24 A	10
JX2.5/11/8	24 A	10

CYK2.5NFT

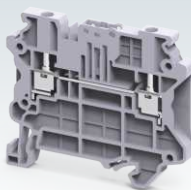

5 x 58.8 mm

53.2 mm / 60.7 mm

IEC	UL - CSA
0.2 - 2.5 mm ²	24 - 14 AWG
0.2 - 4.0 mm ²	24 - 12 AWG
0.2 - 2.5 mm ²	24 - 14 AWG

0.5 - 1.5 mm ²	24 - 16 AWG
---------------------------	-------------

8 mm

IEC60947-7-1 UL-1059

1000 V	600 V		
24 A	20 A		
0.4 Nm	4.5 lb-in		



Polyamide 6,6 / 1

6 KV / 3

Type / Cat. No.	Standard Pack
CYK2.5NFT	50

CA701-1M / CA701-1M-S	50 m
CA701-15-1M / CA701-15-1M-S	25 m
CA702 / CA802	50
CA509/K5WHT	100
MC5	10
SCS0.5/3.0 Blade size: 0.5 x 3.0 mm	10

Type / Cat. No.	I _{max}	Standard Pack
JX2.5/2	24 A	100
JX2.5/3	24 A	50
JX2.5/4	24 A	50
JX2.5/5	24 A	50
JX2.5/6	24 A	10
JX2.5/7	24 A	10
JX2.5/8	24 A	10
JX2.5/10	24 A	10
JX2.5/20	24 A	10
JX2.5/11/2	24 A	10
JX2.5/11/8	24 A	10

CYK4

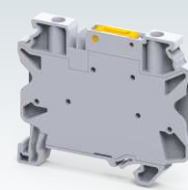

6 x 58.8 mm

51.5 mm / 56.6 mm

IEC	UL - CSA
0.2 - 4.0 mm ²	24 - 10 AWG
0.2 - 6.0 mm ²	
0.2 - 4.0 mm ²	24 - 12 AWG

0.2 - 1.5 mm ²	24 - 16 AWG
0.5 - 2.5 mm ²	20 - 14 AWG

10 mm

IEC60947-7-1 UL-1059

1000 V	600 V		
28 A	26 A		
0.5 Nm	4.5 lb-in		



Polyamide 6,6 / 1

6 KV / 3

Type / Cat. No.	Standard Pack
CYK4	50
CYK4BU	50
CY4	100

CA701-1M / CA701-1M-S	50 m
CA701-15-1M / CA701-15-1M-S	25 m
CA702 / CA802	50
CA509/K6WHT	100
MC6	10
SCS0.6/3.5 Blade size: 0.6 x 3.5 mm	10

Type / Cat. No.	I _{max}	Standard Pack
JX4/2	32 A	100
JX4/3	32 A	50
JX4/4	32 A	50
JX4/5	32 A	50
JX4/6	32 A	50
JX4/8	32 A	10
JX4/10	32 A	10
JX4/16	32 A	10

* Shorting link current should not exceed more than Terminal Block current rating

DISCONNECT & TEST TERMINAL BLOCKS

CYDLK4

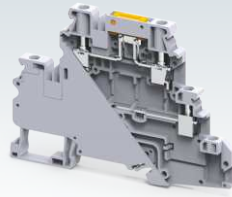
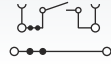

CYDLGK4

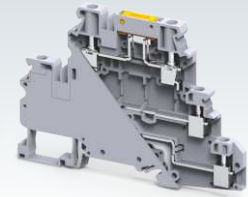

Width (Thickness) x Length	6 x 94.5 mm			
Height with DIN 35 x 7.5 / 35 x 15	67.6 mm / 75.1 mm			
Connection Possibility as per	IEC		UL - CSA	
With 1 Conductor per clamp	Stranded / Flexible	0.2 - 4.0 mm ²	24 - 10 AWG	
	Solid	0.2 - 6.0 mm ²		
With 2 same size Conductors per clamp	with Ferrule / Lug	0.2 - 4.0 mm ²	24 - 12 AWG	
	Stranded / Flexible	0.2 - 1.5 mm ²	24 - 16 AWG	
With 2 same size Conductors per clamp	with TWIN Ferrule / Lug	0.5 - 2.5 mm ²	20 - 14 AWG	
Wire Stripping Length	9 mm			
Ratings As Per	IEC60947-7-1	UL-1059	CSA22.2-158	
Voltage	500 V	300 V	300 V	
Current	Disconnecting Level	28 A	26 A	26 A
	Feed Through Level	32 A	30 A	30 A
Torque	0.5 Nm	4.5 lb-in	4.5 lb-in	

Width (Thickness) x Length	6 x 94.5 mm			
Height with DIN 35 x 7.5 / 35 x 15	67.6 mm / 75.1 mm			
Connection Possibility as per	IEC		UL - CSA	
With 1 Conductor per clamp	Stranded / Flexible	0.2 - 4.0 mm ²	24 - 10 AWG	
	Solid	0.2 - 6.0 mm ²		
With 2 same size Conductors per clamp	with Ferrule / Lug	0.2 - 4.0 mm ²	24 - 12 AWG	
	Stranded / Flexible	0.2 - 1.5 mm ²	24 - 12 AWG	
With 2 same size Conductors per clamp	with TWIN Ferrule / Lug	0.5 - 2.5 mm ²	24 - 14 AWG	
Wire Stripping Length	9 mm			
Ratings As Per	IEC60947-7-1	UL-1059	CSA22.2-158	
Voltage	500 V	300 V	300 V	
Current	Disconnecting Level	28 A	26 A	26 A
	Feed Through Level	32 A	30 A	30 A
Torque	0.5 Nm	4.5 lb-in	4.5 lb-in	

Approvals



Insulation Material / Material Group

Polyamide 6,6 / 1

Polyamide 6,6 / 1

Rated Impulse Voltage / Pollution Degree

6 KV / 3

6 KV / 3

		Type / Cat. No.	Standard Pack
Terminal Block	Grey	CYDLK4	50
		CYDLF4FT	50
Mounting Rail (Refer Pg. 263 for details)		CA701-1M / CA701-1M-S	50 m
		CA701-15-1M / CA701-15-1M-S	25 m
End Clamp (Refer Pg. 264 for details)		CA702 / CA802 / CA202	50
Marking Tags (Refer Pg. 268 for details)		CA509/K6WHT	100
Marker Card (Refer Pg. 269 for details)		MC6	10
Screw Driver		SCS0.6/3.5 Blade size: 0.6 x 3.5 mm	10

		Type / Cat. No.	Standard Pack
Terminal Block		CYDLGK4	50
		CYDLF4FT	50
Mounting Rail (Refer Pg. 263 for details)		CA701-1M / CA701-1M-S	50 m
		CA701-15-1M / CA701-15-1M-S	25 m
End Clamp (Refer Pg. 264 for details)		CA702 / CA802 / CA202	50
Marking Tags (Refer Pg. 268 for details)		CA509/K6WHT	100
Marker Card (Refer Pg. 269 for details)		MC6	10
Screw Driver		SCS0.6/3.5 Blade size: 0.6 x 3.5 mm	10

Jumpers

	Type / Cat. No.	I _{max}	Standard Pack
Pluggable Jumpers	2 pole	JX4/2	32 A 100
	3 pole	JX4/3	32 A 50
	4 pole	JX4/4	32 A 50
	5 pole	JX4/5	32 A 50
	6 pole	JX4/6	32 A 50
	8 pole	JX4/8	32 A 10
	10 pole	JX4/10	32 A 10
	16 pole	JX4/16	32 A 10

	Type / Cat. No.	I _{max}	Standard Pack
Pluggable Jumpers	2 pole	JX4/2	32 A 100
	3 pole	JX4/3	32 A 50
	4 pole	JX4/4	32 A 50
	5 pole	JX4/5	32 A 50
	6 pole	JX4/6	32 A 50
	8 pole	JX4/8	32 A 10
	10 pole	JX4/10	32 A 10
	16 pole	JX4/16	32 A 10

TERMINAL BLOCKS WITH ELECTRONIC COMPONENTS





These are electronic Screw Clamp Double Level Terminal Blocks with built in diodes and LED.

The built in diode acts as a free wheeling diode which is connected across the inductive load such as relay coils, solenoid valves, contactor coils to eliminate or suppress sudden voltage spike which appears across the load when its supply voltage is removed.

CYDL4ELD* Terminal Block has a built in LED circuit for online indication.

CYDL4ED* is specially designed 4 wire spring clamp Terminal Block with a built in diode. This Terminal has a built in 1N4007 diode for reverse polarity protection and also allows uni directional flow of current.

Width (Thickness) x Length	6 x 55.5 mm			
Height with DIN 35 x 7.5 / 35 x 15 / 32 mm Rail	55.7 mm / 63.1 mm / 60.3 mm			
Connection Possibility as per	IEC	UL - CSA		
	With 1 Conductor per clamp	Stranded / Flexible	0.2 - 4.0 mm ²	22 - 10 AWG
		Solid	0.2 - 6.0 mm ²	
		with Ferrule / Lug	0.2 - 4.0 mm ²	22 - 10 AWG
With 2 same size Conductors per clamp	Stranded / Flexible	0.2 - 2.5 mm ²	22 - 12 AWG	
	with TWIN Ferrule / Lug	0.2 - 2.5 mm ²	22 - 12 AWG	
Wire Stripping Length	9 mm			
Ratings As Per	IEC60947-7-1 UL-1059			
Voltage	800 V	300 V		
Current	*	*		
Torque	0.5 Nm	4.5 lb-in		
Approvals				
Insulation Material / Material Group	Polyamide 6,6 / 1			
Diode	1N 4007			
Diode Reverse Voltage / Current	1000 V / 1 A			

	Type / Cat. No.	Standard Pack
End Plate 	EPCYL2.5/4	50
Mounting Rail (Refer Pg. 263 for details) 	CA701-1M / CA701-1M-S	50 m
	CA701-15-1M / CA701-15-1M-S	25 m
Marking Tags (Refer Pg. 268 for details) 	CA509/K6WHT	100
Marker Card (Refer Pg. 269 for details)	MC6	10
Screw Driver 	SCS0.6/3.5 Blade size: 0.6 x 3.5 mm	10

	Type / Cat. No.	I _{max}	Standard Pack	
Jumpers 	2 pole	JX4/2	32 A	100
	3 pole	JX4/3	32 A	50
	4 pole	JX4/4	32 A	50
	5 pole	JX4/5	32 A	50
	6 pole	JX4/6	32 A	50
	8 pole	JX4/8	32 A	10
	10 pole	JX4/10	32 A	10
16 pole	JX4/16	32 A	10	

Part No.	Application	Std. Pack
CYDL4ED1	Arc suppression circuit for contactors & solenoid valves - D.C	50

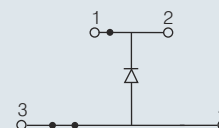

Part No.	Application	Std. Pack
CYDL4ED2	Arc suppression circuit for contactors & solenoid valves - D.C	50

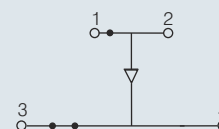
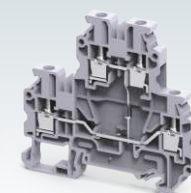

Part No.	Application	Std. Pack
CYDL4ED3	Diode circuit for reverse polarity protection	50

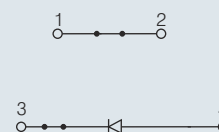

Part No.	Application	Std. Pack
CYDL4EDD1	Diode circuit for lamp testing	50

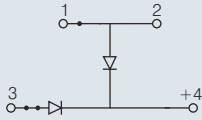

Part No.	Application	Std. Pack
CYDL4EDD2	Diode circuit for lamp testing	50

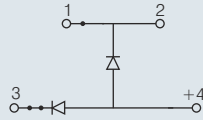

Part No.	Application	Std. Pack
CYDL4EDD3	Diode circuit for lamp testing	50

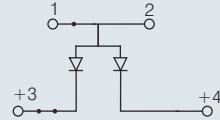

Part No.	Application	Std. Pack
CYDL4EDD4	Diode circuit for lamp testing	50

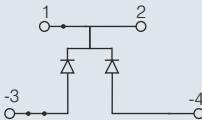

Part No.	Application	Std. Pack
CYDL4ED4	Diode circuit for lamp testing with LED series resistance	50

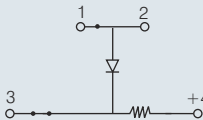

Part No.	Application	Std. Pack
CDL4UEDD5	Diode circuit for lamp testing with LED series resistance	50

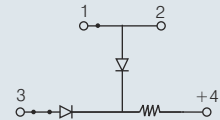

Part No.	Application	Std. Pack
CYDL4ELD1	DC Voltage indicator with LED	50

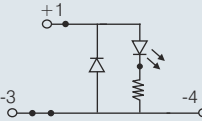

Part No.	Application	Std. Pack
CYDL4ELD2	DC Voltage indicator with LED	50

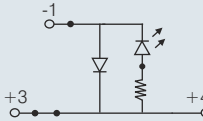

Part No.	Application	Std. Pack
CYDL4ELD3	AC Voltage indicator with LED	50

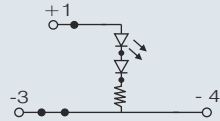

Part No.	Application	Std. Pack
CYDL4ELD4	AC Voltage indicator with LED	50

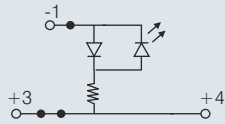

Part No.	Application	Std. Pack
CYDL4ELD5	AC Voltage indicator with LED	50

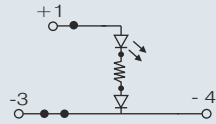

Part No.	Application	Std. Pack
CYDL4EL1	DC Voltage indicator with LED	50

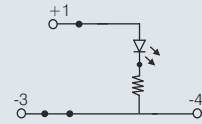

Part No.	Application	Std. Pack
CYDL4EL2	DC Voltage indicator with LED	50

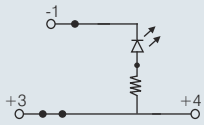







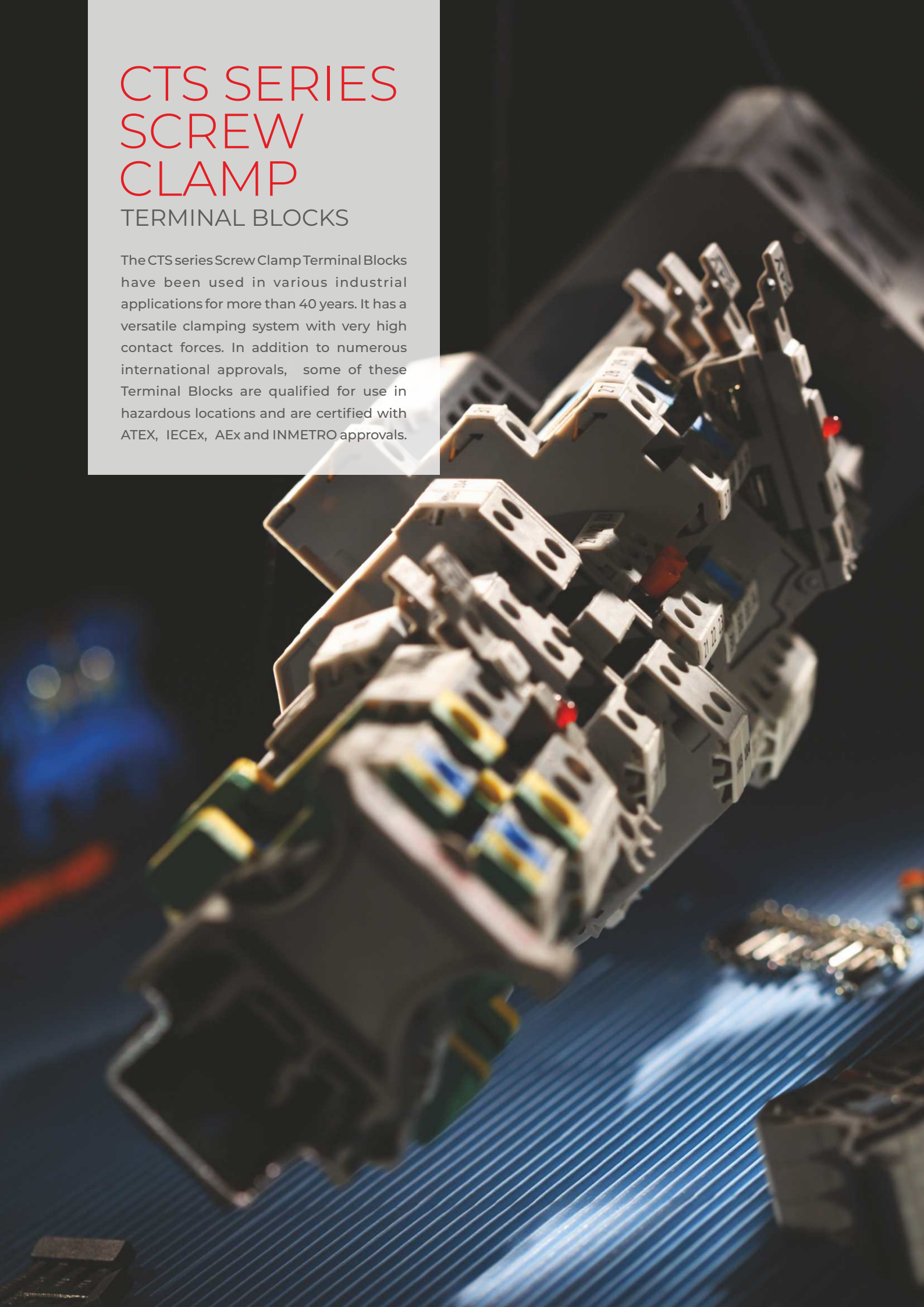











CTS SERIES SCREW CLAMP

TERMINAL BLOCKS

The CTS series Screw Clamp Terminal Blocks have been used in various industrial applications for more than 40 years. It has a versatile clamping system with very high contact forces. In addition to numerous international approvals, some of these Terminal Blocks are qualified for use in hazardous locations and are certified with ATEX, IECEx, AEx and INMETRO approvals.



CTS SERIES SCREW CLAMP TERMINAL BLOCKS

	Standard Feed Through	135 - 140
	Multiple Connection	141 - 142
	Multiple Level	143 - 150
	Ground / Earth	151 - 156
	Neutral / Earth Clamps	157 - 158
	Screw & Spring Type Shield Connection Clamps	159 - 160
	Fuse Terminal	161 - 162
	Double Level Fuse	163 - 164
	Disconnect & Test	165 - 178
	Distribution Blocks	179 - 183
	Compact Distribution Blocks	184 - 186
	Lighting Pole Distribution Blocks	187 - 188
	Component Carrier	189
	High Voltage	191 - 192
	Spring Loaded	193 - 196
	Micro & Panel Mount	197 - 200
	Thermocouple & Tab Connection	201 - 202
	With Electronic Components	203 - 208

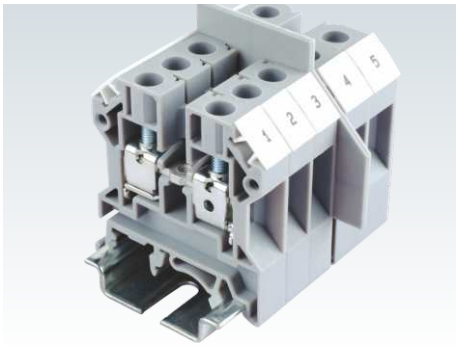

A high torque clamping system on the Screw Clamp Terminal Blocks ensures safe, gas tight connections. Cold forged, rolled threaded screws ensure highly reliable connections.

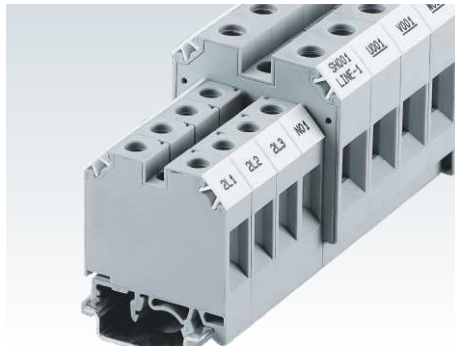

All Terminal Blocks for connecting 16mm² wires and above have a built-in integral end plate thereby covering all live parts. This ensures safe isolation for power connections.

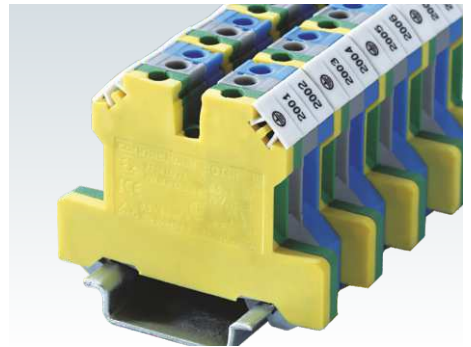

Same profile grounding terminals are clearly identified with a green-yellow housing. Their shape and thickness is identical to the respective feed through terminal of same wire size.



In high current Terminal Blocks, an additional auxiliary terminal can be connected. This enables an additional connection of upto 6 mm² wires.



Multiple connection Terminal Blocks enable secure connection of more than one wire in a single Terminal Block.



Two level plus ground and Three level plus ground terminals facilitate single & three phase connections. These Terminal Blocks are an ideal choice for three phase and three phase plus ground circuits.

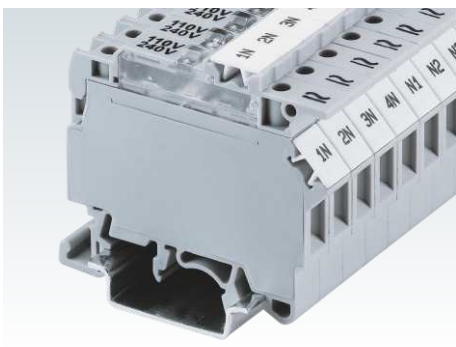

Universal voltage rating of 6 - 60V & 110 - 240V is available on Fuse Terminal Blocks with offline indication. Both AC & DC circuits can be connected without any polarisation requirement.

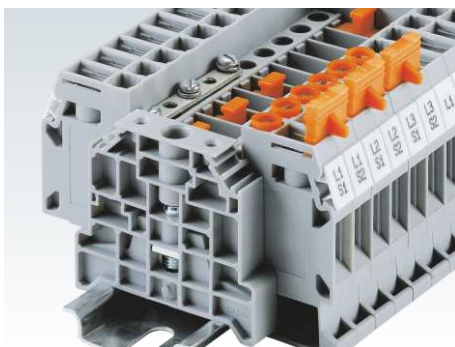

CDS6U Terminal Block system is a versatile wire connection method for current & voltage transformer and power meters. A wide range of accessories eases the testing of connected instruments.

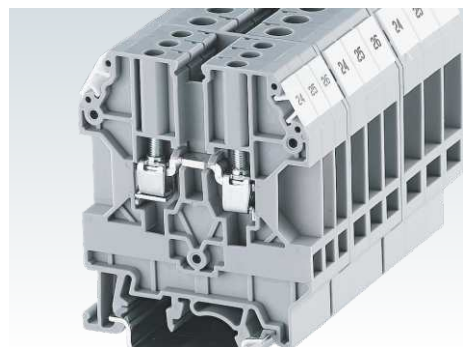

The CHV series High Voltage Terminal Blocks are suitable for upto 1500V DC applications required in the solar industry. The specially designed creepage and clearance distances help achieve the high voltage specifications.

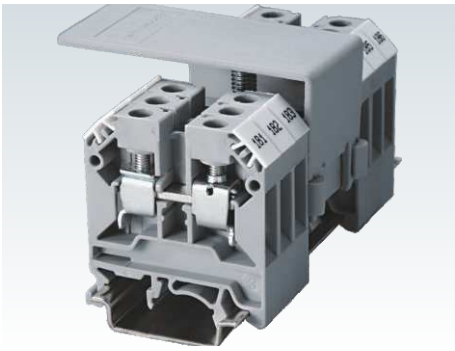

CDB & CMDDB series distribution blocks are an ideal choice for power and signal distribution applications. They have an IP20 rating and no additional shrouds are required.

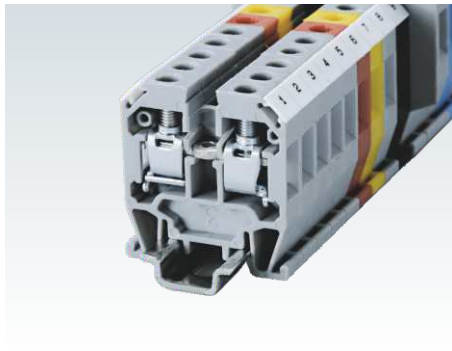

Miniature Terminal Blocks are an ideal choice for compact junction box applications. These Terminal Blocks can be mounted on DIN 15 rails.

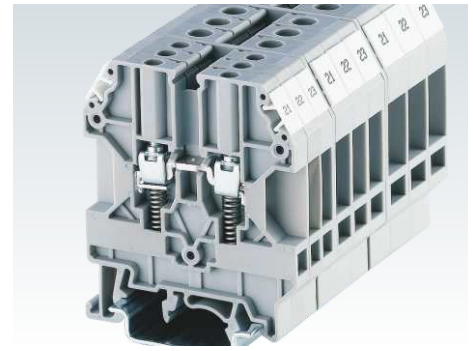

Spring Loaded Terminal Blocks are designed as per ESI standards and meet CEGB, SEC and NTPC guidelines.

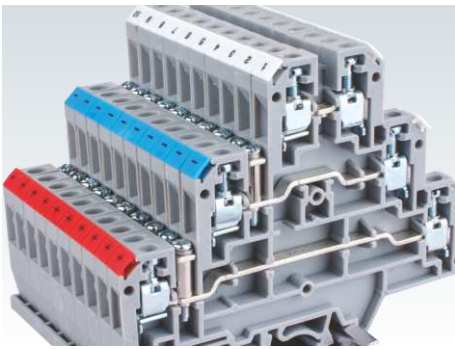

CTL series Terminal Blocks can be used for connecting sensors and actuators in control systems. Standard screw type jumpers are used to create configurations for ease of voltage distribution.

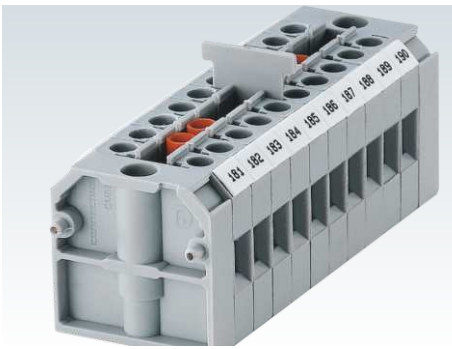

Panel mounted Terminal Blocks eliminate the need for using DIN rails. Individual terminals can be 'clicked' into each other to create specific pole configurations as per user requirements.

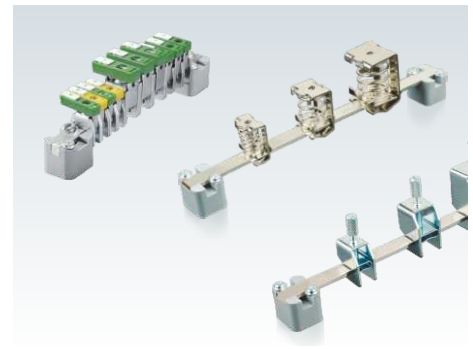

Shield connection clamps facilitate EMC continuity of shielded cables. Neutral & Earth clamps provides flexible solutions for terminating neutral & earthing wires on bus bars.

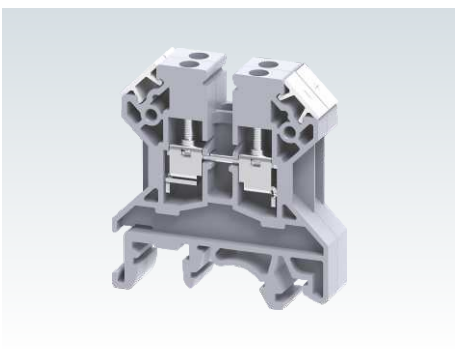

CTT series Terminal Blocks are used to terminate thermocouple wires. Different variants are available to connect 'K', 'J', 'T' and 'E' type thermocouple wires.

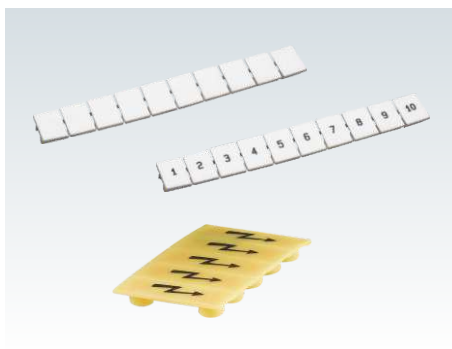

Standardized marking solutions are available to create clear and user friendly Terminal Block assemblies. Users can order blank or custom configured marking tags.

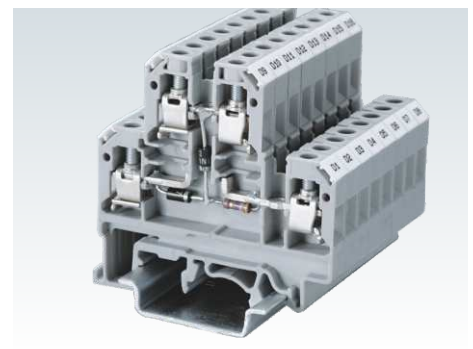















A wide range of functional Terminal Blocks are available with built in electronic components.

STANDARD FEED THROUGH TERMINAL BLOCKS

These Feed Through Terminal Blocks are the most versatile terminals for Control, Automation, Instrumentation and Power Distribution applications. A specially designed flexible foot enables easy mounting and dismounting from the DIN rail with the help of a screw driver. These Terminal Blocks have marker holding recesses to accept marking tags for circuit identification. Cross connection can be achieved with the aid of screw type jumpers.

The terminals with  & IECEx approval can be used in potentially explosive atmosphere. For detailed information refer page 289.

Width (Thickness) x Length		5 x 43 mm			
Height with DIN 35 x 7.5 / 35 x 15 / 32 mm Rail		46.2 mm / 53.7 mm / 51.1 mm			
Connection Possibility as per		IEC		UL - CSA	
With 1 Conductor per clamp	Stranded / Flexible	0.2 - 2.5 mm ²	22 - 12 AWG		
	Solid	0.2 - 4.0 mm ²	22 - 10 AWG		
	with Ferrule / Lug	0.2 - 2.5 mm ²	22 - 12 AWG		
With 2 same size Conductors per clamp	Stranded / Flexible	0.2 - 1.5 mm ²	22 - 16 AWG		
	with TWIN Ferrule / Lug	0.2 - 1.5 mm ²	22 - 16 AWG		
Wire Stripping Length		8 mm			
Ratings As Per		IEC60947-7-1	UL-1059	CSA22.2-158	IEC 60079-7
Voltage		1000 V	600 V	600 V	690 V
Current		24 A	25 A	25 A	21 A
Torque		0.4 Nm	7 lb-in	7 lb-in	0.4 Nm
Approvals					
Insulation Material / Material Group		Polyamide 6,6 / 1			
Rated Impulse Voltage / Pollution Degree		8 KV / 3			
		Type / Cat. No.		Standard Pack	
Terminal Block	Grey	CTS2.5UN		100	
	Blue	CTS2.5UNBU		100	
	Red	CTS2.5UNR		100	
	Yellow	CTS2.5UNY		100	
	Black	CTS2.5UNBK		100	
	Green	CTS2.5UNGN		100	
	Orange	CTS2.5UNO		100	
	White	CTS2.5UNW		100	
	Ground / Earth	CGT4N (Refer Pg. 152 for details)		50	
End Plate		EP2.5/4UN		50	
Partition Plate		PP2.5/4UN		50	
Separator Plate		SP2.5/4UN		100	
Mounting Rail (Refer Pg. 263 for details)		CA701-1M / CA701-1M-S		50 m	
		CA701-15-1M / CA701-15-1M-S		25 m	
End Clamp (Refer Pg. 264 for details)		CA702 / CA802		50	
Marking Tags (Refer Pg. 268 for details)		CA509/K5WHT		100	
Marker Card (Refer Pg. 269 for details)		MC5		10	
Screw Driver		SCS0.5/3	Blade size: 0.5 x 3.0 mm		10
Jumpers		Uninsulated	Insulated	Imax	Standard Pack
Screw Type Jumpers	2 pole	CA721/2	CA741/2	24 A	100
	3 pole	CA721/3	CA741/3	24 A	100
	4 pole	CA721/4	CA741/4	24 A	100
	10 pole	CA721/10	CA741/10	24 A	10
	100 pole	CA721/100	CA741/100	24 A	10
Configurable Jumper Bar	2 pole	CA703/01		24 A	100
	3 pole	CA704/01		24 A	100
	4 pole	CA705/01		24 A	100
	10 pole	CA731/10		24 A	100
	10 pole (Breakable)	CA731/100		24 A	10
Short Sleeve & Screw for configurable jumper bar		CA707/S/Q/01		100	
Switchable Jumpers		CA706/01		24 A	100
Long Sleeve & Screw for Switchable Jumpers		CA707/L/Q/01		100	
External Jumpers	2 pole		CA717/2	24 A	100
	3 pole		CA717/3	24 A	100
	4 pole		CA717/4	24 A	100
	10 pole		CA717/10	24 A	20
Test Socket		CA707/TS/01		100	

CTS2.5UN















Width (Thickness) x Length		5 x 43 mm			
Height with DIN 35 x 7.5 / 35 x 15 / 32 mm Rail		46.2 mm / 53.7 mm / 51.1 mm			
Connection Possibility as per		IEC		UL - CSA	
With 1 Conductor per clamp	Stranded / Flexible	0.2 - 2.5 mm ²	22 - 12 AWG		
	Solid	0.2 - 4.0 mm ²	22 - 10 AWG		
	with Ferrule / Lug	0.2 - 2.5 mm ²	22 - 12 AWG		
With 2 same size Conductors per clamp	Stranded / Flexible	0.2 - 1.5 mm ²	22 - 16 AWG		
	with TWIN Ferrule / Lug	0.2 - 1.5 mm ²	22 - 16 AWG		
Wire Stripping Length		8 mm			
Ratings As Per		IEC60947-7-1	UL-1059	CSA22.2-158	IEC 60079-7
Voltage		1000 V	600 V	600 V	690 V
Current		24 A	25 A	25 A	21 A
Torque		0.4 Nm	7 lb-in	7 lb-in	0.4 Nm



Insulation Material / Material Group: Polyamide 6,6 / 1

Rated Impulse Voltage / Pollution Degree: 8 KV / 3

		Type / Cat. No.		Standard Pack	
Terminal Block	Grey	CTS2.5UN		100	
	Blue	CTS2.5UNBU		100	
	Red	CTS2.5UNR		100	
	Yellow	CTS2.5UNY		100	
	Black	CTS2.5UNBK		100	
	Green	CTS2.5UNGN		100	
	Orange	CTS2.5UNO		100	
	White	CTS2.5UNW		100	
	Ground / Earth	CGT4N (Refer Pg. 152 for details)		50	
End Plate		EP2.5/4UN		50	
Partition Plate		PP2.5/4UN		50	
Separator Plate		SP2.5/4UN		100	
Mounting Rail (Refer Pg. 263 for details)		CA701-1M / CA701-1M-S		50 m	
		CA701-15-1M / CA701-15-1M-S		25 m	
End Clamp (Refer Pg. 264 for details)		CA702 / CA802		50	
Marking Tags (Refer Pg. 268 for details)		CA509/K5WHT		100	
Marker Card (Refer Pg. 269 for details)		MC5		10	
Screw Driver		SCS0.5/3	Blade size: 0.5 x 3.0 mm		10
Jumpers		Uninsulated	Insulated	Imax	Standard Pack
Screw Type Jumpers	2 pole	CA721/2	CA741/2	24 A	100
	3 pole	CA721/3	CA741/3	24 A	100
	4 pole	CA721/4	CA741/4	24 A	100
	10 pole	CA721/10	CA741/10	24 A	10
	100 pole	CA721/100	CA741/100	24 A	10
Configurable Jumper Bar	2 pole	CA703/01		24 A	100
	3 pole	CA704/01		24 A	100
	4 pole	CA705/01		24 A	100
	10 pole	CA731/10		24 A	100
	10 pole (Breakable)	CA731/100		24 A	10
Short Sleeve & Screw for configurable jumper bar		CA707/S/Q/01		100	
Switchable Jumpers		CA706/01		24 A	100
Long Sleeve & Screw for Switchable Jumpers		CA707/L/Q/01		100	
External Jumpers	2 pole		CA717/2	24 A	100
	3 pole		CA717/3	24 A	100
	4 pole		CA717/4	24 A	100
	10 pole		CA717/10	24 A	20
Test Socket		CA707/TS/01		100	

CTS2.5UE



6 x 43 mm

46.2 mm / 53.7 mm / 51.1 mm

IEC	UL - CSA
0.2 - 4.0 mm ²	22 - 10 AWG
0.2 - 6.0 mm ²	
0.2 - 4.0 mm ²	22 - 10 AWG
0.2 - 2.5 mm ²	22 - 12 AWG
0.2 - 2.5 mm ²	22 - 12 AWG

8 mm

IEC60947-7-1 UL-1059 CSA22.2-158 IEC 60079-7

1000 V	600 V	600 V	690 V
30 A	35 A	30 A	28 A
0.5 Nm	7 lb-in	7 lb-in	0.4 Nm



Polyamide 6,6 / 1

8 KV / 3

Type / Cat. No.	Standard Pack		
CTS2.5UE	100		
CTS2.5UEBU	100		
CTS2.5UER	100		
CTS2.5UEY	100		
CTS2.5UEBK	100		
CTS2.5UEGN	100		
CTS2.5UEO	100		
CTS2.5UEW	100		
CGT4N (Refer Pg. 152 for details)	50		
EP2.5/4UN	50		
PP2.5/4UN	50		
SP2.5/4UN	100		
CA701-1M / CA701-1M-S	50 m		
CA701-15-1M / CA701-15-1M-S	25 m		
CA702 / CA802	50		
CA509/K6WHT	100		
MC6	10		
SCS0.6/3.5 Blade size: 0.6 x 3.5 mm	10		
Uninsulated	Insulated	Imax	Standard Pack
CA722/2	CA742/2	32 A	100
CA722/3	CA742/3	32 A	100
CA722/4	CA742/4	32 A	100
CA722/10	CA742/10	32 A	10
CA722/100	CA742/100	32 A	10
CA703/1		32 A	100
CA704/1		32 A	100
CA705/1		32 A	100
CA732/10		32 A	100
CA732/10-A		32 A	100
CA732/100		32 A	10
CA707/S/Q/01			100
CA706/1		32A	100
CA707/L/Q/01			100
	CA713/2	30 A	100
	CA713/3	30 A	100
	CA713/4	30 A	100
	CA713/10	30 A	20
CA707/TS/01			100

CTS4UN



6 x 43 mm

46.2 mm / 53.7 mm / 51.1 mm

IEC	UL - CSA
0.2 - 4.0 mm ²	22 - 10 AWG
0.2 - 6.0 mm ²	
0.2 - 4.0 mm ²	22 - 10 AWG
0.2 - 2.5 mm ²	22 - 12 AWG
0.2 - 2.5 mm ²	22 - 12 AWG

8 mm

IEC60947-7-1 UL-1059 CSA22.2-158 IEC 60079-7

1000 V	600 V	600 V	690 V
32 A	35 A	35 A	28 A
0.5 Nm	7 lb-in	7 lb-in	0.5 Nm



Polyamide 6,6 / 1

8 KV / 3

Type / Cat. No.	Standard Pack		
CTS4UN	100		
CTS4UNBU	100		
CTS4UNR	100		
CTS4UNY	100		
CTS4UNBK	100		
CTS4UNGN	100		
CTS4UNO	100		
CTS4UNW	100		
CGT4N (Refer Pg. 152 for details)	50		
EP2.5/4UN	50		
PP2.5/4UN	50		
SP2.5/4UN	100		
CA701-1M / CA701-1M-S	50 m		
CA701-15-1M / CA701-15-1M-S	25 m		
CA702 / CA802	50		
CA509/K6WHT	100		
MC6	10		
SCS0.6/3.5 Blade size: 0.6 x 3.5 mm	10		
Uninsulated	Insulated	Imax	Standard Pack
CA722/2	CA742/2	32 A	100
CA722/3	CA742/3	32 A	100
CA722/4	CA742/4	32 A	100
CA722/10	CA742/10	32 A	10
CA722/100	CA742/100	32 A	10
CA703/1		32 A	100
CA704/1		32 A	100
CA705/1		32 A	100
CA732/10		32 A	100
CA732/10-A		32 A	100
CA732/100		32 A	10
CA707/S/Q/01			100
CA706/1		32A	100
CA707/L/Q/01			100
	CA713/2	30 A	100
	CA713/3	30 A	100
	CA713/4	30 A	100
	CA713/10	30 A	20
CA707/TS/01			100

CTS6U



8 x 43 mm

47.8 mm / 55.5 mm / 52.8 mm

IEC	UL - CSA
0.5 - 6.0 mm ²	22 - 8 AWG
0.5 - 6.0 mm ²	
0.5 - 6.0 mm ²	22 - 8 AWG
0.5 - 4.0 mm ²	22 - 10 AWG
0.5 - 4.0 mm ²	22 - 10 AWG

9 mm

IEC60947-7-1 UL-1059 CSA22.2-158 IEC 60079-7

1000 V	600 V	600 V	690 V
41 A	50 A	50 A	36 A
0.8 Nm	14 lb-in	14 lb-in	0.8 Nm



Polyamide 6,6 / 1

8 KV / 3

Type / Cat. No.	Standard Pack		
CTS6U	100		
CTS6UBU	100		
CTS6UR	100		
CTS6UY	100		
CTS6UBK	100		
CTS6UGN	100		
CTS6UO	100		
CTS6UW	100		
CGT6N (Refer Pg. 153 for details)	50		
EP6/10U	50		
PP6/10U	50		
SP6/10U	100		
CA701-1M / CA701-1M-S	50 m		
CA701-15-1M / CA701-15-1M-S	25 m		
CA702 / CA802	50		
CA509/K8WHT	100		
MC8	10		
SCS0.8/4 Blade size: 0.8 x 4 mm	10		
Uninsulated	Insulated	Imax	Standard Pack
CA723/2	CA743/2	41 A	100
CA723/3	CA743/3	41 A	50
CA723/4	CA743/4	41 A	50
CA723/10	CA743/10	41 A	10
CA703/2		41 A	100
CA704/2		41 A	100
CA705/2		41 A	100
CA733/10		41 A	100
CA707/S/Q/1			100
CA706/2		41A	100
CA707/L/Q/1			100
	CA710/2	35 A	100
	CA710/3	35 A	50
	CA710/4	35 A	50
	CA710/10	35 A	20
CA707/TS/05			100

STANDARD FEED THROUGH TERMINAL BLOCKS

CTS10U



CTS16U

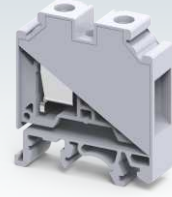

Width (Thickness) x Length	10 x 43 mm
----------------------------	------------

Width (Thickness) x Length	10 x 43 mm
----------------------------	------------

Height with DIN 35 x 7.5 / 35 x 15 / 32 mm Rail	47.8 mm / 55.5 mm / 52.8 mm
---	-----------------------------

Height with DIN 35 x 7.5 / 35 x 15 / 32 mm Rail	47.8 mm / 55.5 mm / 52.8 mm
---	-----------------------------

Connection Possibility as per	
-------------------------------	--

IEC	UL - CSA
-----	----------

With 1 Conductor per clamp	Stranded / Flexible	0.5 - 10.0 mm ²	16 - 6 AWG
	Solid with Ferrule / Lug	0.5 - 10.0 mm ²	16 - 6 AWG

With 1 Conductor per clamp	Stranded / Flexible	0.5 - 10.0 mm ²	16 - 6 AWG
	Solid with Ferrule / Lug	0.5 - 10.0 mm ²	16 - 6 AWG

With 2 same size Conductors per clamp	Stranded / Flexible	0.5 - 6.0 mm ²	16 - 10 AWG
	with TWIN Ferrule / Lug	0.5 - 6.0 mm ²	16 - 10 AWG

With 2 same size Conductors per clamp	Stranded / Flexible	0.5 - 6.0 mm ²	16 - 10 AWG
	with TWIN Ferrule / Lug	0.5 - 6.0 mm ²	16 - 10 AWG

Wire Stripping Length	11 mm
-----------------------	-------

Wire Stripping Length	11 mm
-----------------------	-------

Ratings As Per	IEC60947-7-1	UL-1059	CSA22.2-158	IEC 60079-7
----------------	--------------	---------	-------------	-------------

Ratings As Per	IEC60947-7-1	UL-1059	CSA22.2-158	IEC 60079-7
----------------	--------------	---------	-------------	-------------

Voltage	1000 V	600 V	600 V	690 V
---------	--------	-------	-------	-------

Voltage	1000 V	600 V	600 V	690 V
---------	--------	-------	-------	-------

Current	57 A	65 A	65 A	50 A
---------	------	------	------	------

Current	57 A	65 A	65 A	50 A
---------	------	------	------	------

Torque	1.2 Nm	14 lb-in	14 lb-in	1.2 Nm
--------	--------	----------	----------	--------

Torque	1.2 Nm	14 lb-in	14 lb-in	1.2 Nm
--------	--------	----------	----------	--------

Approvals				
-----------	--	--	--	--

Approvals				
-----------	--	--	--	--

Insulation Material / Material Group	Polyamide 6,6 / 1			
--------------------------------------	-------------------	--	--	--

Insulation Material / Material Group	Polyamide 6,6 / 1			
--------------------------------------	-------------------	--	--	--

Rated Impulse Voltage / Pollution Degree	8 KV / 3			
--	----------	--	--	--

Rated Impulse Voltage / Pollution Degree	8 KV / 3			
--	----------	--	--	--

Type / Cat. No.	Standard Pack
-----------------	---------------

Type / Cat. No.	Standard Pack
-----------------	---------------

Terminal Block	Grey	CTS10U	100
	Blue	CTS10UBU	100
	Red	CTS10UR	100
	Yellow	CTS10UY	100
	Black	CTS10UBK	100
	Green	CTS10UGN	100
	Orange	CTS10UO	100
	White	CTS10UW	100
	Ground / Earth	CGT10N (Refer Pg. 154 for details)	50

Terminal Block	Grey	CTS16U	50
	Blue	CTS16UBU	50
	Red	CTS16UR	50
	Yellow	CTS16UY	50
	Black	CTS16UBK	50
	Green	CTS16UGN	50
	Orange	CTS16UO	50
	White	CTS16UW	50
	Ground / Earth	CGT16N (Refer Pg. 154 for details)	50

End Plate		EP6/10U	50
-----------	--	---------	----

End Plate		EP6/10U	50
-----------	--	---------	----

Partition Plate		PP6/10U	50
-----------------	--	---------	----

Partition Plate		PP6/10U	50
-----------------	--	---------	----

Separator Plate		SP6/10U	100
-----------------	--	---------	-----

Separator Plate		SP6/10U	100
-----------------	--	---------	-----

Mounting Rail (Refer Pg. 263 for details)		CA701-1M / CA701-1M-S	50 m
		CA701-15-1M / CA701-15-1M-S	25 m

Mounting Rail (Refer Pg. 263 for details)		CA701-1M / CA701-1M-S	50 m
		CA701-15-1M / CA701-15-1M-S	25 m

End Clamp (Refer Pg. 264 for details)		CA702 / CA802	50
---------------------------------------	--	---------------	----

End Clamp (Refer Pg. 264 for details)		CA702 / CA802	50
---------------------------------------	--	---------------	----

Marking Tags (Refer Pg. 268 for details)		CA509/K10WHT	100
--	--	--------------	-----

Marking Tags (Refer Pg. 268 for details)		CA509/K10WHT	100
--	--	--------------	-----

Marker Card (Refer Pg. 269 for details)		MC10	10
---	--	------	----

Marker Card (Refer Pg. 269 for details)		MC12	10
---	--	------	----

Screw Driver		SCS0.8/4	Blade size: 0.8 x 4 mm	10
--------------	--	----------	------------------------	----

Screw Driver		SCS1.0/5.5	Blade size: 1.0 x 5.5 mm	10
--------------	--	------------	--------------------------	----

Jumpers	Uninsulated	Insulated	I _{max}	Standard Pack
---------	-------------	-----------	------------------	---------------

Jumpers	Uninsulated	Insulated	I _{max}	Standard Pack
---------	-------------	-----------	------------------	---------------

Screw Type Jumpers		2 pole	CA724/2	CA744/2	57 A	100
		3 pole	CA724/3	CA744/3	57 A	50
		4 pole	CA724/4	CA744/4	57 A	50
		10 pole	CA724/10	CA744/10	57 A	10

Screw Type Jumpers		2 pole	CA751/2	CA761/2	65 A	50
		3 pole	CA751/3	CA761/3	65 A	50
		4 pole	CA751/4	CA761/4	65 A	50
		10 pole	CA751/10	CA761/10	65 A	10

Configurable Jumper Bar		2 pole	CA703/3		57 A	100
		3 pole	CA704/3		57 A	100
		4 pole	CA705/3		57 A	100
		10 pole	CA734/10		57 A	100

Configurable Jumper Bar		2 pole	CA703/8		65 A	100
		3 pole	CA704/8		65 A	100
		4 pole	CA705/8		65 A	100
		10 pole	CA739/10		65 A	100

Short Sleeve & Screw for configurable jumper bar		CA707/S/Q/1				100
--	--	-------------	--	--	--	-----

Short Sleeve & Screw for configurable jumper bar		CA707/S/Q/1				100
--	--	-------------	--	--	--	-----

Switchable Jumpers		CA706/3		57 A		100
--------------------	--	---------	--	------	--	-----

Switchable Jumpers		CA706/3		57 A		100
--------------------	--	---------	--	------	--	-----

Long Sleeve & Screw for Switchable Jumpers		CA707/L/Q/1				100
--	--	-------------	--	--	--	-----

Long Sleeve & Screw for Switchable Jumpers		CA707/L/Q/1				100
--	--	-------------	--	--	--	-----

External Jumpers		2 pole		CA718/2	57 A	100
		3 pole		CA718/3	57 A	50
		4 pole		CA718/4	57 A	50
		10 pole		CA718/10	57 A	20

External Jumpers		2 pole				
		3 pole				
		4 pole				
		10 pole				

Test Socket		CA707/TS/05				100
-------------	--	-------------	--	--	--	-----

Test Socket		CA707/TS/05				100
-------------	--	-------------	--	--	--	-----

Width (Thickness) x Length	12 x 43 mm
----------------------------	------------

Height with DIN 35 x 7.5 / 35 x 15 / 32 mm Rail	47.8 mm / 55.5 mm / 52.8 mm
---	-----------------------------

Connection Possibility as per	
-------------------------------	--

With 1 Conductor per clamp	Stranded / Flexible	0.2 - 16.0 mm ²	20 - 4 AWG
	Solid with Ferrule / Lug	0.2 - 16.0 mm ²	20 - 4 AWG

With 2 same size Conductors per clamp	Stranded / Flexible	0.2 - 10.0 mm ²	20 - 8 AWG
	with TWIN Ferrule / Lug	0.2 - 10.0 mm ²	20 - 8 AWG

Wire Stripping Length	12 mm
-----------------------	-------

Ratings As Per	IEC60947-7-1	UL-1059	CSA22.2-158	IEC 60079-7
----------------	--------------	---------	-------------	-------------

Voltage	1000 V	600 V	600 V	690 V
---------	--------	-------	-------	-------

Current	76 A	85 A	70 A	66 A
---------	------	------	------	------

Torque	1.2 Nm	14 lb-in	14 lb-in	2.0 Nm
--------	--------	----------	----------	--------

Approvals				
-----------	--	--	--	--

Insulation Material / Material Group	Polyamide 6,6 / 1			
--------------------------------------	-------------------	--	--	--

Rated Impulse Voltage / Pollution Degree	8 KV / 3			
--	----------	--	--	--

Type / Cat. No.	Standard Pack
-----------------	---------------

Terminal Block	Grey	CTS16U	50
	Blue	CTS16UBU	50
	Red	CTS16UR	50
	Yellow	CTS16UY	50
	Black	CTS16UBK	50
	Green	CTS16UGN	50
	Orange	CTS16UO	50
	White	CTS16UW	50
	Ground / Earth	CGT16N (Refer Pg. 154 for details)	50

End Plate		EP6/10U	50
-----------	--	---------	----

Partition Plate		PP6/10U	50
-----------------	--	---------	----

Separator Plate		SP6/10U	100
-----------------	--	---------	-----

Mounting Rail (Refer Pg. 263 for details)		CA701-1M / CA701-1M-S	50 m
		CA701-15-1M / CA701-15-1M-S	25 m

End Clamp (Refer Pg. 264 for details)		CA702 / CA802	50
---------------------------------------	--	---------------	----

Marking Tags (Refer Pg. 268 for details)		CA509/K12WHT	100
--	--	--------------	-----

Marker Card (Refer Pg. 269 for details)		MC12	10
---	--	------	----

Screw Driver		SCS1.0/5.5	Blade size: 1.0 x 5.5 mm	10
--------------	--	------------	--------------------------	----

Jumpers	Uninsulated	Insulated	I _{max}	Standard Pack
---------	-------------	-----------	------------------	---------------

Screw Type Jumpers		2 pole	CA751/2	CA761/2	65 A	50
		3 pole	CA751/3	CA761/3	65 A	50
		4 pole	CA751/4	CA761/4	65 A	50
		10 pole	CA751/10	CA761/10	65 A	10

Configurable Jumper Bar		2 pole	CA703/8		65 A	100
		3 pole	CA704/8		65 A	100
		4 pole	CA705/8		65 A	100
		10 pole	CA739/10		65 A	100

Short Sleeve & Screw for configurable jumper bar		CA707/S/Q/1				100
--	--	-------------	--	--	--	-----

Switchable Jumpers		CA706/3		57 A		100
--------------------	--	---------	--	------	--	-----

Long Sleeve & Screw for Switchable Jumpers		CA707/L/Q/1				100
--	--	-------------	--	--	--	-----

External Jumpers		2 pole				
		3 pole				
		4 pole				
		10 pole				

CTS25UN



12 x 48 mm
57.2 mm / 64.7 mm / 62.3 mm

IEC	UL - CSA
4.0 - 25.0 mm ²	14 - 2 AWG
4.0 - 25.0 mm ²	14 - 2 AWG
4.0 - 16 mm ²	14 - 4 AWG
4.0 - 10 mm ²	14 - 6 AWG

14 mm

IEC60947-7-1 UL-1059 CSA22.2-158 IEC 60079-7

1000 V	600 V	600 V	690 V
101 A	105 A	85 A	88 A
2.0 Nm	30 lb-in	18 lb-in	2.0 Nm



Polyamide 6,6 / 1

8 KV / 3

Type / Cat. No.	Standard Pack
CTS25UN	50
CTS25UNBU	50
CTS25UNNR	50
CTS25UNY	50
CTS25UNBK	50
CTS25UNGN	50

CTS35UN

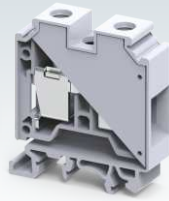

16 x 50.5 mm
59.2 mm / 66.7 mm / 64.3 mm

IEC	UL - CSA
4.0 - 35.0 mm ²	12 - 1/0 AWG
4.0 - 35.0 mm ²	12 - 1/0 AWG
4.0 - 16.0 mm ²	12 - 4 AWG
4.0 - 16.0 mm ²	12 - 8 AWG

15 mm

IEC60947-7-1 UL-1059 CSA22.2-158 IEC 60079-7

1000 V	600 V	600 V	800 V
125 A	150 A	150 A	109 A
2.5 Nm	50 lb-in	50 lb-in	2.5 Nm



Polyamide 6,6 / 1

8 KV / 3

Type / Cat. No.	Standard Pack
CTS35UN	50
CTS35UNBU	50
CTS35UNNR	50
CTS35UNY	50
CTS35UNBK	50
CTS35UNGN	50

CGT35U (Refer Pg. 155 for details) 20

PP35UN 50

CA701-1M / CA701-1M-S 50 m
CA701-15-1M / CA701-15-1M-S 25 m

CA702 / CA802 50

CA509/K16WHT 100

MC16 10

SCS1.0/5.5 Blade size: 1.0 x 5.5 mm 10

Uninsulated	Insulated	I _{max}	Standard Pack
CA725/2	CA745/2	90 A	50
CA725/3	CA745/3	90 A	20
CA725/4	CA745/4	90 A	20
CA725/10	CA745/10	90 A	10

CA703/4	90 A	100
CA704/4	90 A	100
CA705/4	90 A	100
CA735/10	90 A	100

CA707/S/Q/2 100

CA707/TS/06 100

CTS35UNA

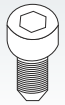

With Allen screw



16 x 50.5 mm
59.2 mm / 66.7 mm / 64.3 mm

IEC	UL - CSA
4.0 - 35.0 mm ²	12 - 2 AWG
4.0 - 35.0 mm ²	12 - 2 AWG
4.0 - 16.0 mm ²	12 - 4 AWG
4.0 - 16.0 mm ²	12 - 8 AWG

15 mm

IEC60947-7-1 UL-1059 CSA22.2-158

1000 V	600 V	600 V
125 A	150 A	150 A
3 Nm	50 lb-in	50 lb-in



Polyamide 6,6 / 1

8 KV / 3

Type / Cat. No.	Standard Pack
CTS35UNA	50
CTS35UNABU	50
CTS35UNAR	50
CTS35UNAY	50
CTS35UNABK	50
CTS35UNAGN	50

CGT35U (Refer Pg. 155 for details) 20

PP35UN 50

CA701-1M / CA701-1M-S 50 m
CA701-15-1M / CA701-15-1M-S 25 m

CA702 / CA802 50

CA509/K16WHT 100

MC16 10

SCS1.0/5.5 Blade size: 1.0 x 5.5 mm 10

Uninsulated	Insulated	I _{max}	Standard Pack
CA771/2	CA781/2	105 A	50
CA771/3	CA781/3	105 A	20
CA771/4	CA781/4	105 A	20
CA771/10	CA781/10	105 A	10

CA703/10	105 A	100
CA704/10	105 A	100
CA705/10	105 A	100
CA770/10	105 A	10

CA707/S/Q/2 100

CA707/TS/06 100

STANDARD FEED THROUGH TERMINAL BLOCKS

CTS50/70N



CTS50/70NA

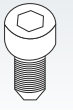

With Allen screw



Width (Thickness) x Length		20.5 x 77 mm				20.5 x 77 mm									
Height with DIN 35 x 7.5 / 35 x 15 / 32 mm Rail		71.1 mm / 78.1 mm				71.1 mm / 78.1 mm									
Connection Possibility as per		IEC		UL - CSA		IEC		UL - CSA							
With 1 Conductor per clamp	Stranded / Flexible with Ferrule / Lug	10.0 - 70.0 mm ²		8 - 2/0 AWG		10.0 - 70.0 mm ²		8 - 2/0 AWG							
		10.0 - 70.0 mm ²		8 - 2/0 AWG		10.0 - 70.0 mm ²		8 - 2/0 AWG							
With 2 same size Conductors per clamp		Stranded / Flexible		10.0 - 35.0 mm ²		8 - 2 AWG		10.0 - 35.0 mm ²		8 - 2 AWG					
Wire Stripping Length		22 mm				22 mm									
Ratings As Per		IEC60947-7-1		UL-1059		CSA22.2-158		IEC60947-7-1		UL-1059		CSA22.2-158			
Voltage		1000 V		1000 V		1000 V		1000 V		1000 V		1000 V			
Current		192 A		175 A		175 A		192 A		175 A		175 A			
Torque		3.0 Nm		38 lb-in		38 lb-in		3.0 Nm		38 lb-in		38 lb-in			
Approvals															
Insulation Material / Material Group		Polyamide 6,6 / 1				Polyamide 6,6 / 1									
Rated Impulse Voltage / Pollution Degree		8 KV / 3				8 KV / 3									
		Type / Cat. No.		Standard Pack		Type / Cat. No.		Standard Pack							
Terminal Block	Grey	CTS50/70N		20		CTS50/70NA		20							
	Blue	CTS50/70NBU		20		CTS50/70NABU		20							
	Red	CTS50/70NR		20		CTS50/70NAR		20							
	Yellow	CTS50/70NY		20		CTS50/70NAY		20							
	Black	CTS50/70NBK		20		CTS50/70NABK		20							
	Green	CTS50/70NGN		20		CTS50/70NAGN		20							
	Ground / Earth	CGT50/70N (Refer Pg. 155 for details)		20		CGT50/70N (Refer Pg. 155 for details)		20							
Auxiliary / Pick Off Terminal		AUX6		10		AUX6		10							
Mounting Rail (Refer Pg. 263 for details)		CA701-1M / CA701-1M-S		50 m		CA701-1M / CA701-1M-S		50 m							
		CA701-15-1M / CA701-15-1M-S		25 m		CA701-15-1M / CA701-15-1M-S		25 m							
End Clamp (Refer Pg. 264 for details)		CA202 / CA102		50		CA202 / CA102		50							
Marking Tags (Refer Pg. 268 for details)		CA509/K16WHT		100		CA509/K16WHT		100							
Marker Card (Refer Pg. 269 for details)		MC16		10		MC16		10							
		Type / Cat. No.		Imax		Standard Pack		Type / Cat. No.		Imax		Standard Pack			
Screw Type Jumpers		2 pole		CA628/2		192 A		10		CA628/2		192 A		10	
		3 pole		CA628/3		192 A		10		CA628/3		192 A		10	

CTS95/120N



With Allen screw

27 x 85 mm

83.0 mm / 90.5 mm

IEC	UL - CSA
25.0 - 120.0 mm ²	2 - 250 kcmil
25.0 - 120.0 mm ²	2 - 250 kcmil

25.0 - 70 mm² 2 - 2/0 AWG

24 mm

IEC60947-7-1	UL-1059	CSA22.2-158
1000 V	1000 V	1000 V
269 A	240 A	240 A
6.0 Nm	90 lb-in	90 lb-in



Polyamide 6,6 / 1

8 KV / 3

Type / Cat. No.	Standard Pack
CTS95/120N	10
CTS95/120NBU	10
CTS95/120NR	10
CTS95/120NY	10
CTS95/120NBK	10
CTS95/120NGN	10

AUX6	10
CA701-1M / CA701-1M-S	50 m
CA701-15-1M / CA701-15-1M-S	25 m
CA202 / CA102	50
CA509/K16WHT	100
MC16	10

Type / Cat. No.	I _{max}	Standard Pack
CA629/2	269 A	10
CA629/3	269 A	10

AUX6 (Auxiliary Terminal Block)

In certain power circuits, there is a need to take an extra connection for an Auxiliary circuit like an indicating light or contactor. The AUX6 terminal easily plugs into the terminal and provides this extra connection point.

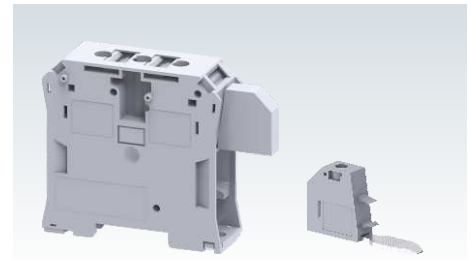

Width (Thickness) x Length x Height

8 x 53.6 x 29.4 mm

With 1 Conductor per clamp	Stranded / Flexible	0.5 - 6.0 mm ²	22 - 8 AWG
	Solid with Ferrule / Lug		
With 2 same size Conductors per clamp	Stranded / Flexible	0.5 - 6.0 mm ²	22 - 8 AWG
	with TWIN Ferrule / Lug		
	Stranded / Flexible	0.5 - 4.0 mm ²	22 - 10 AWG
	with TWIN Ferrule / Lug		

Ratings As Per

IEC60947-7-1 UL-1059 CSA22.2-158 IEC 60079-7

Voltage

1000 V 600 V 600 V 630 V

Current

41 A 50 A 50 A 36 A

Torque

0.8 Nm 14 lb-in 14 lb-in 0.8 Nm

Auxiliary Terminal

Type / Cat. No.	Standard Pack	Suitable For
AUX6	10	CTS50/70N CTS50/70NA CTS95/120N

Marking Tag



CA509/K8WHT	100	AUX6
-------------	-----	------

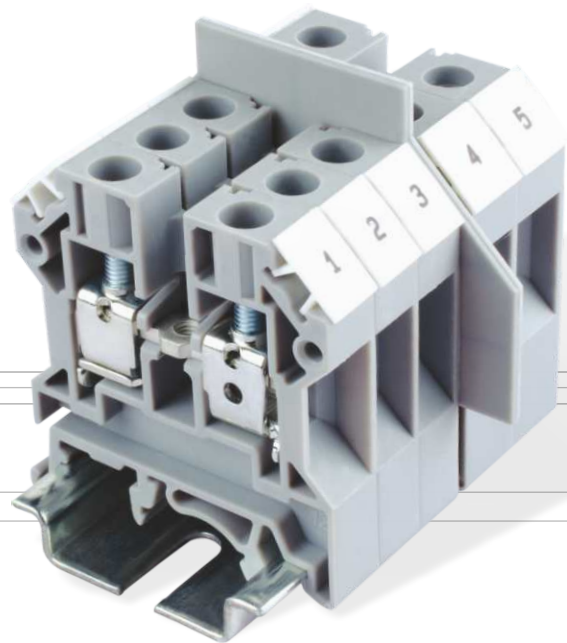

MULTIPLE CONNECTION TERMINAL BLOCKS

These blocks are used to connect multiple wires in a single Terminal Block, thereby eliminating reliability problems encountered when connecting multiple wires in a single clamp.

CMCG4 ground terminal enables the connection of grounding wires and is available in standard Green-Yellow colour.

The terminals with  & IECEx approval can be used in potentially explosive atmosphere. For detailed information refer page 289.

Width (Thickness) x Length		6 x 46.5 mm			
Height with DIN 35 x 7.5 / 35 x 15 / 32 mm Rail		49.5 mm / 56.5 mm / 53.3 mm			
Connection Possibility as per		IEC		UL - CSA	
With 1 Conductor per clamp	Stranded / Flexible	0.2 - 4.0 mm ²		22 - 10 AWG	
	Solid with Ferrule / Lug	0.2 - 6.0 mm ²		22 - 10 AWG	
With 2 same size Conductors per clamp	Stranded / Flexible	0.2 - 4.0 mm ²		22 - 10 AWG	
	with TWIN Ferrule / Lug	0.2 - 2.5 mm ²		22 - 12 AWG	
Wire Stripping Length		9 mm			
Ratings As Per		IEC60947-7-1	UL-1059	CSA22.2-158	IEC 60079-7
Voltage		630 V	600 V	600 V	500 V
Current		32 A	35 A	35 A	28 A
Torque		0.5 Nm	7 lb-in	7 lb-in	0.5 Nm
Approvals					
Insulation Material / Material Group		Polyamide 6,6 / 1			
Rated Impulse Voltage / Pollution Degree		8 KV / 3			
		Type / Cat. No.	Standard Pack		
Terminal Block		CMC1-2	100		
		CMC1-2BU	100		
End Plate		EPCMC1-2	50		
Mounting Rail (Refer Pg. 263 for details)		CA701-1M / CA701-1M-S	50 m		
		CA701-15-1M / CA701-15-1M-S	25 m		
End Clamp (Refer Pg. 264 for details)		CA702 / CA802	50		
Marking Tags (Refer Pg. 268 for details)		CA509/K6WHT	100		
Marker Card (Refer Pg. 269 for details)		MC6	10		
Screw Driver		SCS0.6/3.5	Blade size: 0.6 x 3.5 mm		10
Jumpers		Uninsulated	Insulated	Imax	Standard Pack
Screw Type Jumpers	2 pole	CA722/2	CA742/2	32 A	100
	3 pole	CA722/3	CA742/3	32 A	100
	4 pole	CA722/4	CA742/4	32 A	100
	10 pole	CA722/10	CA742/10	32 A	10
	100 pole	CA722/100	CA742/100	32 A	10
Configurable Jumper Bar	2 pole	CA703/1		32 A	100
	3 pole	CA704/1		32 A	100
	4 pole	CA705/1		32 A	100
	10 pole	CA732/10		32 A	100
	10 pole (Breakable)	CA732/10-A		32 A	100
	100 pole	CA732/100		32 A	10
Short Sleeve & Screw for configurable jumper bar		CA707/S/Q/01		100	
External Jumpers	2 pole		CA713/2	30 A	100
	3 pole		CA713/3	30 A	100
	4 pole		CA713/4	30 A	100
	10 pole		CA713/10	30 A	20
Test Socket		CA707/TS/01		100	

* External Jumpers can be used only in the upper level clamping unit of the Terminal Block.

ODL2.5A(I.S)



5 x 62 mm

61 mm / 68.5 mm

IEC	UL - CSA
0.2 - 2.5 mm ²	24 - 12 AWG
0.2 - 4.0 mm ²	
0.2 - 2.5 mm ²	24 - 12 AWG
0.2 - 1.5 mm ²	24 - 16 AWG
0.2 - 1.5 mm ²	24 - 16 AWG

8 mm

IEC60947-7-1 UL-1059 CSA22.2-158

800 V	300 V	300 V
24 A	25 A	25 A
0.4 Nm	4.5 lb-in	4.5 lb-in



Polyamide 6,6 / 1

8 KV / 3

Type / Cat. No.	Standard Pack
ODL2.5A(I.S)	50
ODL2.5(I.S)	50
EPODL2.5	50
EP1ODL2.5	50
CA701-1M / CA701-1M-S	50 m
CA701-15-1M / CA701-15-1M-S	25 m
CA702 / CA802 / CA202	50
CA509/K5WHT	100
MC5	10
SCS0.5/3 Blade size: 0.5 x 3.0 mm	10

Type / Cat. No.	I _{max}	Standard Pack
JX2.5/2	24 A	100
JX2.5/3	24 A	50
JX2.5/4	24 A	50
JX2.5/5	24 A	50
JX2.5/6	24 A	10
JX2.5/7	24 A	10
JX2.5/8	24 A	10
JX2.5/10	24 A	10
TX2.5		20

ODLG2.5A



5 x 62 mm

61 mm / 68.5 mm

IEC	UL - CSA
0.2 - 2.5 mm ²	24 - 12 AWG
0.2 - 4.0 mm ²	
0.2 - 2.5 mm ²	24 - 12 AWG
0.2 - 1.5 mm ²	24 - 16 AWG
0.2 - 1.5 mm ²	24 - 16 AWG

8 mm

IEC60947-7-1 UL-1059 CSA22.2-158

800 V	300 V	300 V
24 A	25 A	25 A
0.4 Nm	4.5 lb-in	4.5 lb-in



Polyamide 6,6 / 1

8 KV / 3

Type / Cat. No.	Standard Pack
ODLG2.5A	50
ODLG2.5	50
EPODL2.5	50
EP1ODL2.5	50
CA701-1M / CA701-1M-S	50 m
CA701-15-1M / CA701-15-1M-S	25 m
CA702 / CA802 / CA202	50
CA509/K5WHT	100
MC5	10
SCS0.5/3 Blade size: 0.5 x 3.0 mm	10

Type / Cat. No.	I _{max}	Standard Pack
JX2.5/2	24 A	100
JX2.5/3	24 A	50
JX2.5/4	24 A	50
JX2.5/5	24 A	50
JX2.5/6	24 A	10
JX2.5/7	24 A	10
JX2.5/8	24 A	10
JX2.5/10	24 A	10
TX2.5		20

ODLG2.5A(I.S)



5 x 62 mm

61 mm / 68.5 mm

IEC	UL - CSA
0.2 - 2.5 mm ²	24 - 12 AWG
0.2 - 4.0 mm ²	
0.2 - 2.5 mm ²	24 - 12 AWG
0.2 - 1.5 mm ²	24 - 16 AWG
0.2 - 1.5 mm ²	24 - 16 AWG

8 mm

IEC60947-7-1 UL-1059 CSA22.2-158

800 V	300 V	300 V
24 A	25 A	25 A
0.4 Nm	4.5 lb-in	4.5 lb-in



Polyamide 6,6 / 1

8 KV / 3

Type / Cat. No.	Standard Pack
ODLG2.5A(I.S)	50
ODLG2.5(I.S)	50
EPODL2.5	50
EP1ODL2.5	50
CA701-1M / CA701-1M-S	50 m
CA701-15-1M / CA701-15-1M-S	25 m
CA702 / CA802 / CA202	50
CA509/K5WHT	100
MC5	10
SCS0.5/3 Blade size: 0.5 x 3.0 mm	10

Type / Cat. No.	I _{max}	Standard Pack
JX2.5/2	24 A	100
JX2.5/3	24 A	50
JX2.5/4	24 A	50
JX2.5/5	24 A	50
JX2.5/6	24 A	10
JX2.5/7	24 A	10
JX2.5/8	24 A	10
JX2.5/10	24 A	10
TX2.5		20

CDL4UN

CDL4UN(I.S)



Width (Thickness) x Length	6 x 57 mm			
Height with DIN 35 x 7.5 / 35 x 15 / 32 mm Rail	59.5 mm / 67.2 mm / 64.5 mm			
Connection Possibility as per	IEC	UL - CSA		
	With 1 Conductor per clamp	Stranded / Flexible Solid	0.2 - 4.0 mm ² 0.2 - 6.0 mm ²	22 - 10 AWG
With 2 same size Conductors per clamp	Stranded / Flexible with TWIN Ferrule / Lug	0.2 - 4.0 mm ²	22 - 10 AWG	
	Stranded / Flexible with TWIN Ferrule / Lug	0.2 - 2.5 mm ² 0.2 - 2.5 mm ²	22 - 12 AWG 22 - 12 AWG	
Wire Stripping Length	9 mm			
Ratings As Per	IEC60947-7-1	UL-1059	CSA22.2-158	IEC 60079-7
Voltage	800 V	600 V	600 V	550 V
Current	32 A	35 A	35 A	28 A
Torque	0.5 Nm	7 lb-in	7 lb-in	0.5 Nm

Width (Thickness) x Length	6 x 57 mm			
Height with DIN 35 x 7.5 / 35 x 15 / 32 mm Rail	59.5 mm / 67.2 mm / 64.5 mm			
Connection Possibility as per	IEC	UL - CSA		
	With 1 Conductor per clamp	Stranded / Flexible Solid	0.2 - 4.0 mm ² 0.2 - 6.0 mm ²	22 - 10 AWG
With 2 same size Conductors per clamp	Stranded / Flexible with TWIN Ferrule / Lug	0.2 - 4.0 mm ²	22 - 10 AWG	
	Stranded / Flexible with TWIN Ferrule / Lug	0.2 - 2.5 mm ² 0.2 - 2.5 mm ²	22 - 12 AWG 22 - 12 AWG	
Wire Stripping Length	9 mm			
Ratings As Per	IEC60947-7-1	UL-1059	CSA22.2-158	IEC 60079-7
Voltage	800 V	600 V	600 V	
Current	32 A	35 A	35 A	
Torque	0.5 Nm	7 lb-in	7 lb-in	

Approvals

Approvals

Insulation Material / Material Group: Polyamide 6,6 / 1
 Rated Impulse Voltage / Pollution Degree: 8 KV / 3

Insulation Material / Material Group: Polyamide 6,6 / 1
 Rated Impulse Voltage / Pollution Degree: 8 KV / 3

		Type / Cat. No.	Standard Pack
Terminal Block	Grey	CDL4UN	100
	Blue	CDL4UNBU	100
	Red	CDL4UNR	100
	Yellow	CDL4UNY	100
	Black	CDL4UNBK	100
	Green	CDL4UNGN	100
	Orange	CDL4UNO	100
	White	CDL4UNW	100
	Ground / Earth	CDLG4(I.S) (Refer Pg. 146 for details)	100
	End Plate	EPCDL4UN	50
Separator Plate	SPCDL4U	100	
Mounting Rail (Refer Pg. 263 for details)	CA701-1M / CA701-1M-S	50 m	
	CA701-15-1M / CA701-15-1M-S	25 m	
End Clamp (Refer Pg. 264 for details)	CA702 / CA802 / CA202	50	
Marking Tags (Refer Pg. 268 for details)	CA509/K6WHT	100	
Marker Card (Refer Pg. 269 for details)	MC6	10	
Screw Driver	SCS0.6/3.5 Blade size: 0.6 x 3.5 mm	10	

		Type / Cat. No.	Standard Pack
Terminal Block	Grey	CDL4UN(I.S)	100
	Blue	CDL4UN(I.S)BU	100
	Red	CDL4UN(I.S)R	100
	Yellow	CDL4UN(I.S)Y	100
	Black	CDL4UN(I.S)BK	100
	Green	CDL4UN(I.S)GN	100
	Orange	CDL4UN(I.S)O	100
	White	CDL4UN(I.S)W	100
	Ground / Earth	CDLG4(I.S) (Refer Pg. 146 for details)	100
	End Plate	EPCDL4UN	50
Separator Plate	SPCDL4U	100	
Mounting Rail (Refer Pg. 263 for details)	CA701-1M / CA701-1M-S	50 m	
	CA701-15-1M / CA701-15-1M-S	25 m	
End Clamp (Refer Pg. 264 for details)	CA702 / CA802 / CA202	50	
Marking Tags (Refer Pg. 268 for details)	CA509/K6WHT	100	
Marker Card (Refer Pg. 269 for details)	MC6	10	
Screw Driver	SCS0.6/3.5 Blade size: 0.6 x 3.5 mm	10	

Jumpers		Uninsulated	Insulated	Imax	Standard Pack
Screw Type Jumpers	2 pole	CA722/2	CA742/2	32 A	100
	3 pole	CA722/3	CA742/3	32 A	100
	4 pole	CA722/4	CA742/4	32 A	100
	10 pole	CA722/10	CA742/10	32 A	10
	100 pole	CA722/100	CA742/100	32 A	10
Configurable Jumper Bar	2 pole	CA703/1		32 A	100
	3 pole	CA704/1		32 A	100
	4 pole	CA705/1		32 A	100
	10 pole	CA732/10		32 A	100
	10 pole (Breakable)	CA732/10-A		32 A	100
100 pole	CA732/100		32 A	10	
Short Sleeve & Screw for configurable jumper bar	CA707/S/Q/01				100
External Jumpers	2 pole		CA714/2	32 A	100
	3 pole		CA714/3	32 A	100
	4 pole		CA714/4	32 A	100
	10 pole		CA714/10	32 A	20
Test Socket	CA707/TS/01				100

Jumpers		Uninsulated	Insulated	Imax	Standard Pack
Screw Type Jumpers	2 pole	CA722/2	CA742/2	32 A	100
	3 pole	CA722/3	CA742/3	32 A	100
	4 pole	CA722/4	CA742/4	32 A	100
	10 pole	CA722/10	CA742/10	32 A	10
	100 pole	CA722/100	CA742/100	32 A	10
Configurable Jumper Bar	2 pole	CA703/1		32 A	100
	3 pole	CA704/1		32 A	100
	4 pole	CA705/1		32 A	100
	10 pole	CA732/10		32 A	100
	10 pole (Breakable)	CA732/10-A		32 A	100
100 pole	CA732/100		32 A	10	
Short Sleeve & Screw for configurable jumper bar	CA707/S/Q/01				100
External Jumpers	2 pole		CA714/2	32 A	100
	3 pole		CA714/3	32 A	100
	4 pole		CA714/4	32 A	100
	10 pole		CA714/10	32 A	20
Test Socket	CA707/TS/01				100

CDLG2.5



CTL2.5U



Width (Thickness) x Length	6 x 71.7 mm			
Height with DIN 35 x 7.5 / 35 x 15 / 32 mm Rail	52.5 mm / 61.0 mm			
Connection Possibility as per	IEC	UL - CSA		
	With 1 Conductor per clamp	Stranded / Flexible	0.2 - 2.5 mm ²	24 - 12 AWG
		Solid	0.2 - 4.0 mm ²	24 - 10 AWG
		with Ferrule / Lug	0.2 - 2.5 mm ²	24 - 12 AWG
With 2 same size Conductors per clamp	Stranded / Flexible	0.2 - 1.5 mm ²	22 - 14 AWG	
	with TWIN Ferrule / Lug	0.2 - 1.5 mm ²	22 - 16 AWG	
Wire Stripping Length	9 mm			
Ratings As Per	IEC60947-7-2	UL-1059		
Voltage	500 V	300 V		
	Current	24 A	24 A	
Torque	0.4 Nm	4.5 lb-in		
	Approvals			
Insulation Material / Material Group	Polyamide 6,6 / 1			
Rated Impulse Voltage / Pollution Degree	6 KV / 3			

Width (Thickness) x Length	6 x 84 mm			
Height with DIN 35 x 7.5 / 35 x 15 / 32 mm Rail	68.0 mm / 75.6 mm / 73.8 mm			
Connection Possibility as per	IEC	UL - CSA		
	With 1 Conductor per clamp	Stranded / Flexible	0.2 - 2.5 mm ²	22 - 12 AWG
		Solid	0.2 - 4.0 mm ²	22 - 10 AWG
		with Ferrule / Lug	0.2 - 2.5 mm ²	22 - 12 AWG
With 2 same size Conductors per clamp	Stranded / Flexible	0.2 - 1.5 mm ²	22 - 14 AWG	
	with TWIN Ferrule / Lug	0.2 - 1.5 mm ²	22 - 14 AWG	
Wire Stripping Length	9 mm			
Ratings As Per	IEC60947-7-1	UL-1059	CSA22.2-158	IEC 60079-7
Voltage	500 V	300 V	300 V	380 V
	Current	24 A	25 A	25 A
Torque	0.4 Nm	4.5 lb-in	4.5 lb-in	0.4 Nm
	Approvals			
Insulation Material / Material Group	Polyamide 6,6 / 1			
Rated Impulse Voltage / Pollution Degree	4 KV / 3			

	Type / Cat. No.	Standard Pack
Terminal Block	CDLG2.5	100
End Plate	EPCDLG2.5	50
Separator Plate	SPCDLG2.5	100
Mounting Rail (Refer Pg. 263 for details)	CA701-1M / CA701-1M-S	50 m
	CA701-15-1M / CA701-15-1M-S	25 m
End Clamp (Refer Pg. 264 for details)	CA702 / CA802 / CA202	50
Marking Tags (Refer Pg. 268 for details)	CA509/K2GWHT	100
Marker Card (Refer Pg. 269 for details)		
Screw Driver	SCS0.5/3 Blade size: 0.5 x 3 mm	10

	Type / Cat. No.	Standard Pack
Terminal Block	CTL2.5U	50
	CTL2.5UBU	50
End Plate	EPCTL2.5U	50
Mounting Rail (Refer Pg. 263 for details)	CA701-1M / CA701-1M-S	50 m
	CA701-15-1M / CA701-15-1M-S	25 m
End Clamp (Refer Pg. 264 for details)	CA702 / CA802 / CA202	50
Marking Tags (Refer Pg. 268 for details)	CA509/K2GWHT	100
Marker Card (Refer Pg. 269 for details)	MC2	10
Screw Driver	SCS0.5/3 Blade size: 0.5 x 3 mm	10

Jumpers	Type / Cat. No.	I _{max}	Standard Pack
Screw Type Jumpers	2 pole	24 A	100
	3 pole	24 A	100
	4 pole	24 A	100
	10 pole	24 A	10
	100 pole		
Jumper Bar	2 pole	24 A	100
	3 pole	24 A	100
	4 pole	24 A	100
	10 pole	24 A	100
	10 pole (Breakable)	24 A	100
	100 pole	24 A	10
Short Sleeve & Screw for configurable jumper bar	CA611/S/Q		100
External Jumpers	2 pole	24 A	100
	3 pole	24 A	100
	4 pole	24 A	100
	10 pole	24 A	20
	10 pole	24 A	20
Test Socket	CA707/TS/01		100

Jumpers	Type / Cat. No.	I _{max}	Standard Pack
Screw Type Jumpers	2 pole	24 A	100
	3 pole	24 A	100
	4 pole	24 A	100
	10 pole	24 A	10
	100 pole		
Jumper Bar	2 pole	24 A	100
	3 pole	24 A	100
	4 pole	24 A	100
	10 pole	24 A	100
	10 pole (Breakable)	24 A	100
	100 pole	24 A	10
Short Sleeve & Screw for configurable jumper bar	CA707/S/Q/01		100
External Jumpers	2 pole	24 A	100
	3 pole	24 A	100
	4 pole	24 A	100
	10 pole	24 A	20
	10 pole	24 A	20
Test Socket	CA707/TS/01		100

CTL2.5UH



6 x 61 mm
68.0 mm / 75.6 mm / 73.8 mm

IEC	UL - CSA
0.2 - 2.5 mm ²	22 - 12 AWG
0.2 - 4.0 mm ²	22 - 10 AWG
0.2 - 2.5 mm ²	22 - 12 AWG
0.2 - 1.5 mm ²	22 - 14 AWG
0.2 - 1.5 mm ²	22 - 14 AWG

9 mm

IEC60947-7-1 UL-1059 CSA22.2-158 IEC 60079-7

500 V	300 V	300 V	380 V
24 A	25 A	25 A	21 A
0.4 Nm	4.5 lb-in	4.5 lb-in	0.4 Nm



Polyamide 6,6 / 1

4 KV / 3

Type / Cat. No.	Standard Pack
CTL2.5UH	50
CTL2.5UHBU	50
EPCTL2.5UH	50

CA701-1M / CA701-1M-S	50 m
CA701-15-1M / CA701-15-1M-S	25 m
CA702 / CA802 / CA202	50
CA509/K2WHT	100
MC2	10
SCS0.5/3 Blade size: 0.5 x 3 mm	10

Type / Cat. No.	I _{max}	Standard Pack
CA722/2	24 A	100
CA722/3	24 A	100
CA722/4	24 A	100
CA722/10	24 A	10
CA722/100	24 A	10
CA703/1	24 A	100
CA704/1	24 A	100
CA705/1	24 A	100
CA732/10	24 A	100
CA732/10-A	24 A	100
CA732/100	24 A	10
CA707/S/Q/01		100
CA715/2	24 A	100
CA715/3	24 A	100
CA715/4	24 A	100
CA715/10	24 A	20
CA707/TS/01		100

CTL2.5U(I.S)

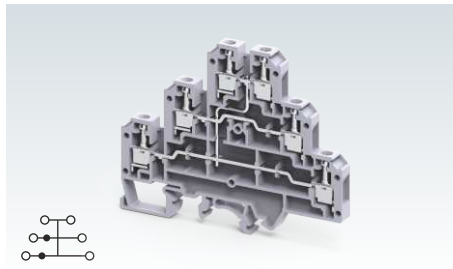

6 x 84 mm
68.0 mm / 75.6 mm / 73.8 mm

IEC	UL - CSA
0.2 - 2.5 mm ²	22 - 12 AWG
0.2 - 4.0 mm ²	22 - 10 AWG
0.2 - 2.5 mm ²	22 - 12 AWG
0.2 - 1.5 mm ²	22 - 14 AWG
0.2 - 1.5 mm ²	22 - 14 AWG

9 mm

IEC60947-7-1 UL-1059 CSA22.2-158

500 V	150 V	150 V
24 A	25 A	25 A
0.4 Nm	4.5 lb-in	4.5 lb-in



Polyamide 6,6 / 1

4 KV / 3

Type / Cat. No.	Standard Pack
CTL2.5U(I.S)	50
EPCTL2.5U	50

CA701-1M / CA701-1M-S	50 m
CA701-15-1M / CA701-15-1M-S	25 m
CA702 / CA802 / CA202	50
CA509/K2WHT	100
MC2	10
SCS0.5/3 Blade size: 0.5 x 3 mm	10

Type / Cat. No.	I _{max}	Standard Pack
CA722/2	24 A	100
CA722/3	24 A	100
CA722/4	24 A	100
CA722/10	24 A	10
CA722/100	24 A	10
CA703/1	24 A	100
CA704/1	24 A	100
CA705/1	24 A	100
CA732/10	24 A	100
CA732/10-A	24 A	100
CA732/100	24 A	10
CA707/S/Q/01		100
CA715/2	24 A	100
CA715/3	24 A	100
CA715/4	24 A	100
CA715/10	24 A	20
CA707/TS/01		100

CTL2.5UH(I.S)D2



6 x 61 mm
68.0 mm / 75.6 mm / 73.8 mm

IEC	UL - CSA
0.2 - 2.5 mm ²	22 - 12 AWG
0.2 - 4.0 mm ²	22 - 10 AWG
0.2 - 2.5 mm ²	22 - 12 AWG
0.2 - 1.5 mm ²	22 - 14 AWG
0.2 - 1.5 mm ²	22 - 14 AWG

9 mm

IEC60947-7-1 UL-1059

500 V	150 V
24 A	25 A
0.4 Nm	4.5 lb-in



Polyamide 6,6 / 1

4 KV / 3

Type / Cat. No.	Standard Pack
CTL2.5UH(I.S)D2	50
EPCTL2.5UH	50

CA701-1M / CA701-1M-S	50 m
CA701-15-1M / CA701-15-1M-S	25 m
CA702 / CA802 / CA202	50
CA509/K2WHT	100
MC2	10
SCS0.5/3 Blade size: 0.5 x 3 mm	10

Type / Cat. No.	I _{max}	Standard Pack
CA722/2	24 A	100
CA722/3	24 A	100
CA722/4	24 A	100
CA722/10	24 A	10
CA722/100	24 A	10
CA703/1	24 A	100
CA704/1	24 A	100
CA705/1	24 A	100
CA732/10	24 A	100
CA732/10-A	24 A	100
CA732/100	24 A	10
CA707/S/Q/01		100
CA715/2	24 A	100
CA715/3	24 A	100
CA715/4	24 A	100
CA715/10	24 A	20
CA707/TS/01		100

CTL2.5UL

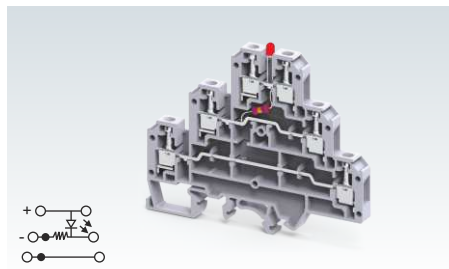

CTL2.5UHL

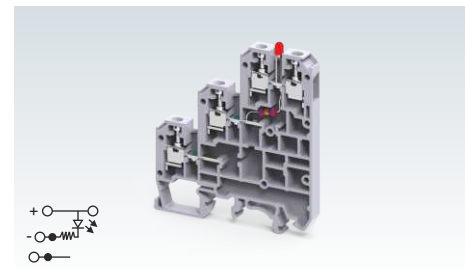

Width (Thickness) x Length	6 x 84 mm			6 x 61 mm				
Height with DIN 35 x 7.5 / 35 x 15 / 32 mm Rail	68.0 mm / 75.6 mm / 73.8 mm			68.0 mm / 75.6 mm / 73.8 mm				
Connection Possibility as per	IEC	UL - CSA		IEC	UL - CSA			
	With 1 Conductor per clamp	Stranded / Flexible	0.2 - 2.5 mm ²	22 - 12 AWG	0.2 - 2.5 mm ²	22 - 12 AWG		
		Solid	0.2 - 4.0 mm ²	22 - 10 AWG	0.2 - 4.0 mm ²	22 - 10 AWG		
		with Ferrule / Lug	0.2 - 2.5 mm ²	22 - 12 AWG	0.2 - 2.5 mm ²	22 - 12 AWG		
With 2 same size Conductors per clamp	Stranded / Flexible	0.2 - 1.5 mm ²	22 - 14 AWG	0.2 - 1.5 mm ²	22 - 14 AWG	22 - 14 AWG		
	with TWIN Ferrule / Lug	0.2 - 1.5 mm ²	22 - 14 AWG	0.2 - 1.5 mm ²	22 - 14 AWG	22 - 14 AWG		
Wire Stripping Length	9 mm			9 mm				
Ratings As Per	IEC60947-7-1	UL-1059	CSA22.2-158	IEC60947-7-1	UL-1059	CSA22.2-158		
Voltage	500 V	300 V	300 V	500 V	300 V	300 V		
	Current	24 A	25 A	25 A	24 A	25 A	25 A	
Torque	0.4 Nm	4.5 lb-in	4.5 lb-in	0.4 Nm	4.5 lb-in	4.5 lb-in		
	Approvals							
Insulation Material / Material Group	Polyamide 6,6 / 1			Polyamide 6,6 / 1				
Rated Impulse Voltage / Pollution Degree	4 KV / 3			4 KV / 3				
	Type / Cat. No.		Standard Pack	Type / Cat. No.		Standard Pack		
Terminal Block	Grey	CTL2.5UL*	50	CTL2.5UHL*	50			
End Plate		EPCTL2.5U	50	EPCTL2.5UH	50			
Mounting Rail (Refer Pg. 263 for details)		CA701-1M / CA701-1M-S	50 m	CA701-1M / CA701-1M-S	50 m			
		CA701-15-1M / CA701-15-1M-S	25 m	CA701-15-1M / CA701-15-1M-S	25 m			
End Clamp (Refer Pg. 264 for details)		CA702 / CA802 / CA202	50	CA702 / CA802 / CA202	50			
Marking Tags (Refer Pg. 268 for details)		CA509/K2WHT	100	CA509/K2WHT	100			
Marker Card (Refer Pg. 269 for details)		MC2	10	MC2	10			
Screw Driver		SCS0.5/3	Blade size: 0.5 x 3 mm	10	SCS0.5/3	Blade size: 0.5 x 3 mm	10	
	Type / Cat. No.		I _{max}	Standard Pack	Type / Cat. No.		I _{max}	Standard Pack
Screw Type Jumpers		2 pole	CA722/2	24 A	100	CA722/2	24 A	100
		3 pole	CA722/3	24 A	100	CA722/3	24 A	100
		4 pole	CA722/4	24 A	100	CA722/4	24 A	100
		10 pole	CA722/10	24 A	10	CA722/10	24 A	10
		100 pole	CA722/100	24 A	10	CA722/100	24 A	10
Jumper Bar		2 pole	CA703/1	24 A	100	CA703/1	24 A	100
		3 pole	CA704/1	24 A	100	CA704/1	24 A	100
		4 pole	CA705/1	24 A	100	CA705/1	24 A	100
		10 pole	CA732/10	24 A	100	CA732/10	24 A	100
		10 pole (Breakable)	CA732/10-A	24 A	100	CA732/10-A	24 A	100
		100 pole	CA732/100	24 A	10	CA732/100	24 A	10
Short Sleeve & Screw for configurable jumper bar		CA707/S/Q/01		100	CA707/S/Q/01		100	
External Jumpers		2 pole	CA715/2	24 A	100	CA715/2	24 A	100
		3 pole	CA715/3	24 A	100	CA715/3	24 A	100
		4 pole	CA715/4	24 A	100	CA715/4	24 A	100
		10 pole	CA715/10	24 A	20	CA715/10	24 A	20
		Test Socket		CA707/TS/01		100	CA707/TS/01	

* Standard voltage for "LED Indication" is 12 V D.C. Other variations in voltage is available on request. Add required voltage to Type / Cat. No. as suffix e.g. CTL2.5UL24 for 24V D.C.

CTLG2.5



6 x 87.5 mm

66.0 mm / 74.0 mm

IEC	UL - CSA
0.2 - 2.5 mm ²	24 - 12 AWG
0.2 - 4.0 mm ²	24 - 10 AWG
0.2 - 2.5 mm ²	24 - 12 AWG
0.2 - 1.5 mm ²	24 - 14 AWG
0.2 - 1.5 mm ²	24 - 14 AWG

9 mm

IEC60947-7-1 UL-1059

440 V	300 V		
24 A	24 A		
0.4 Nm	4.5 lb-in		



Polyamide 6,6 / 1

6 KV / 3

Type / Cat. No.	Standard Pack
CTLG2.5	50
EPCTLG2.5	50
CA701-1M / CA701-1M-S	50 m
CA701-15-1M / CA701-15-1M-S	25 m
CA702 / CA802 / CA202	50
CA509/K2GWHT	100

SCS0.5/3 Blade size: 0.5 x 3 mm 10

Type / Cat. No.	I _{max}	Standard Pack
CA627/2	24 A	100
CA627/3	24 A	100
CA627/4	24 A	100
CA627/10	24 A	10
CA703/1	24 A	100
CA704/1	24 A	100
CA705/1	24 A	100
CA732/10	24 A	100
CA732/10-A	24 A	100
CA732/100	24 A	10

CA611/S/Q 100

CA715/2	24 A	100
CA715/3	24 A	100
CA715/4	24 A	100
CA715/10	24 A	20
CA707/TS/01		100

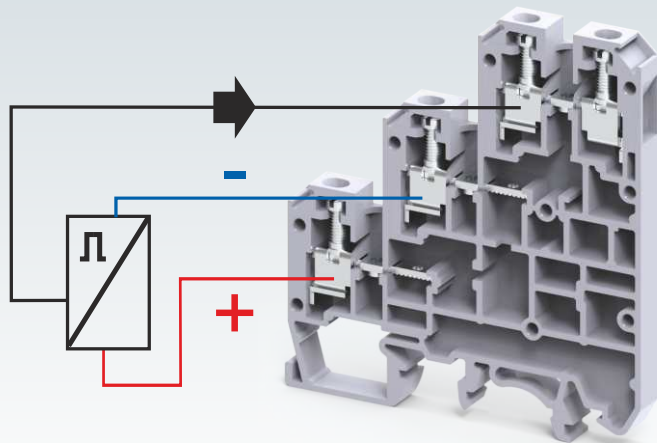
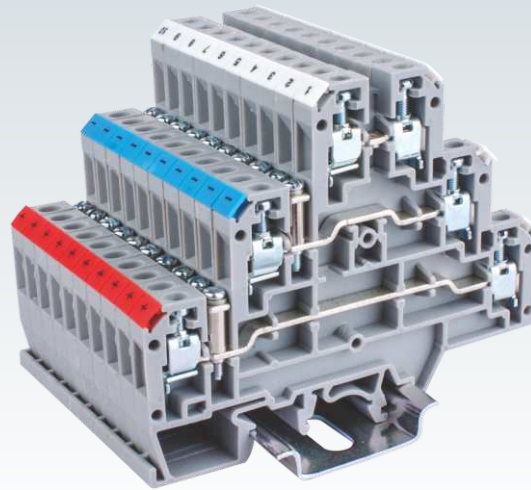

GROUND / EARTH TERMINAL BLOCKS

CTSG & CGT series Terminal Blocks are used for terminating Grounding / Earthing wires. They are green-yellow colour coded as per industry standards.

CTSG2.5 & CTSG4 are of the same profile with CTS2.5UN & CTS4UN feed through terminals respectively. These terminals can be directly snapped on the Din Rail Terminal Blocks.

CGT4N, CGT6N, CGT10N, CGT16N & CGT50/70N terminals can be mounted only on the DIN 35 & DIN 35-15 Rails. They have the same top profile as their respective feed through Terminal Blocks.

CGT4U, CGT10U & CGT35U can be mounted on the DIN 35 and DIN 32 rails.



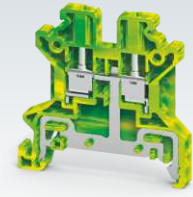

CGMT4 is suitable for DIN 15 micro rail & can be used in conjunction with CMT4 (Pg - 197) Terminal Blocks.

The terminals with  & IECEx approval can be used in potentially explosive atmosphere. For detailed information refer page 289.

CTSG2.5



Width (Thickness) x Length	5 x 45.7 mm		
Height with DIN 35 x 7.5 / 35 x 15 / 32 mm Rail	45.8 mm / 53.3 mm		
Connection Possibility as per	IEC	UL - CSA	
With 1 Conductor per clamp	Stranded / Flexible	0.2 - 2.5 mm ²	22 - 12 AWG
	Solid	0.2 - 4.0 mm ²	22 - 10 AWG
	with Ferrule / Lug	0.2 - 2.5 mm ²	22 - 12 AWG
With 2 same size Conductors per clamp	Stranded / Flexible	0.2 - 1.5 mm ²	22 - 16 AWG
	with TWIN Ferrule / Lug	0.2 - 1.5 mm ²	22 - 16 AWG
Wire Stripping Length	8 mm		
Ratings As Per			
Torque			
Torque at Center Screw	0.4 Nm	7 lb-in	
Approvals			
Insulation Material / Material Group	Polyamide 6,6 / 1		
Rated Impulse Voltage / Pollution Degree	8 KV / 3		

	Type / Cat. No.	Standard Pack
Terminal Block	CTSG2.5	50
End Plate 		
Mounting Rail (Refer Pg. 263 for details) 	CA701-1M / CA701-1M-S	50 m
	CA701-15-1M / CA701-15-1M-S	25 m
Marking Tags (Refer Pg. 268 for details) 	CA509/K5WHT	100
Marker Card (Refer Pg. 269 for details)	MC5	10
Screw Driver 	SCS0.5/3 Blade size: 0.5 x 3 mm	10

CTSG4

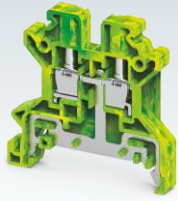

6 x 45.7 mm
45.8 mm / 53.3 mm

IEC	UL - CSA
0.2 - 4.0 mm ²	22 - 10 AWG
0.2 - 6.0 mm ²	
0.2 - 4.0 mm ²	22 - 10 AWG
0.2 - 2.5 mm ²	22 - 12 AWG
0.2 - 2.5 mm ²	22 - 12 AWG

8 mm

0.5 Nm 7 lb-in



Polyamide 6,6 / 1

8 KV / 3

Type / Cat. No.	Standard Pack
CTSG4	50
CA701-1M / CA701-1M-S	50 m
CA701-15-1M / CA701-15-1M-S	25 m
CA509/K6WHT	100
MC6	10
SCS0.6/3.5 Blade size: 0.6 x 3.5 mm	10

CGT4N



6 x 54.5 mm
47.0 mm / 54.4 mm

IEC	UL - CSA
0.2 - 4.0 mm ²	22 - 10 AWG
0.2 - 6.0 mm ²	
0.2 - 4.0 mm ²	22 - 10 AWG
0.2 - 2.5 mm ²	22 - 12 AWG
0.2 - 2.5 mm ²	22 - 12 AWG

8 mm

IEC60947-2 UL-1059 CSA22.2-158 IEC 60079-7

0.5 Nm 7 lb-in 7 lb-in 0.5 Nm
0.8 Nm 7 lb-in 7 lb-in



Polyamide 6,6 / 1

8 KV / 3

Type / Cat. No.	Standard Pack
CGT4N	50
CA701-1M / CA701-1M-S	50 m
CA701-15-1M / CA701-15-1M-S	25 m
CA509/K6WHT	100
MC6	10
SCS0.6/3.5 Blade size: 0.6 x 3.5 mm	10

CGT4U



6 x 43 mm
49.5 mm / 56.7 mm / 54.3 mm

IEC	UL - CSA
0.2 - 4.0 mm ²	22 - 10 AWG
0.2 - 6.0 mm ²	
0.2 - 4.0 mm ²	22 - 10 AWG
0.2 - 2.5 mm ²	22 - 12 AWG
0.2 - 2.5 mm ²	22 - 12 AWG

8 mm

IEC60947-2 UL-1059 CSA22.2-158 IEC 60079-7

0.5 Nm 7 lb-in 7 lb-in 0.5 Nm
0.8 Nm 7 lb-in 7 lb-in



Polyamide 6,6 / 1

8 KV / 3

Type / Cat. No.	Standard Pack
CGT4U	50
EPCGT4UY	50
CA701-1M / CA701-1M-S	50 m
CA701-15-1M / CA701-15-1M-S	25 m
CA501-1M / CA501-1M-S	50 m
CA509/K6WHT	100
MC6	10
SCS0.6/3.5 Blade size: 0.6 x 3.5 mm	10

GROUND / EARTH TERMINAL BLOCKS

CGT series Terminal Blocks are used for terminating Grounding / Earthing wires. They are green-yellow colour coded as per industry standards.

CGT4N, CGT6N, CGT10N, CGT16N & CGT50/70N terminals can be mounted only on the DIN 35 & DIN 35-15 Rails. They have the same top profile as their respective feed through Terminal Blocks.





CGT4U, CGT10U & CGT35U can be mounted on the DIN 35 and DIN 32 rails.

CGMT4 is suitable for DIN 15 micro rail & can be used in conjunction with CMT4 (Pg - 197) Terminal Blocks.

The terminals with  & IECEx approval can be used in potentially explosive atmosphere. For detailed information refer page 289.

Width (Thickness) x Length		8 x 54.5 mm	
Height with DIN 35 x 7.5 / 35 x 15 / 32 mm Rail		48.2 mm / 55.8 mm	
Connection Possibility as per		IEC	UL - CSA
With 1 Conductor per clamp	Stranded / Flexible	0.2 - 6.0 mm ²	22 - 8 AWG
	Solid with Ferrule / Lug	0.2 - 6.0 mm ²	22 - 8 AWG
With 2 same size Conductors per clamp	Stranded / Flexible	0.2 - 4.0 mm ²	22 - 10 AWG
	with TWIN Ferrule / Lug	0.2 - 4.0 mm ²	22 - 10 AWG
Wire Stripping Length		9 mm	
Ratings As Per		IEC60947-2	UL-1059 CSA22.2-158 IEC 60079-7
Torque		1.6 Nm	14 lb-in 14 lb-in 0.8 Nm
Torque at Center Screw		0.8 Nm	7 lb-in 7 lb-in
Approvals			
Insulation Material / Material Group		Polyamide 6,6 / 1	
Rated Impulse Voltage / Pollution Degree		8 KV / 3	



Terminal Block	
Mounting Rail (Refer Pg. 263 for details)	
Marking Tags (Refer Pg. 268 for details)	
Marker Card (Refer Pg. 269 for details)	
Screw Driver	

Type / Cat. No.	Standard Pack
CGT6N	50
CA701-1M / CA701-1M-S	50 m
CA701-15-1M / CA701-15-1M-S	25 m
CA509/K8WHT	100
MC8	10
SCS0.8/4	Blade size: 0.8 x 4 mm 10

CGT10N



10 x 55 mm
48.5 mm / 56.0 mm

IEC	UL - CSA
0.2 - 10.0 mm ²	16 - 6 AWG
0.2 - 10.0 mm ²	16 - 6 AWG
0.2 - 6.0 mm ²	16 - 10 AWG
0.2 - 6.0 mm ²	16 - 10 AWG

11 mm

IEC60947-7-2 UL-1059 CSA22.2-158 IEC 60079-7

1.6 Nm	14 lb-in	14 lb-in	1.2 Nm
1.6 Nm	14 lb-in	14 lb-in	



Polyamide 6,6 / 1

8 KV / 3

CGT10U



10 x 45 mm
51.0 mm / 58.2 mm / 55.7 mm

IEC	UL - CSA
0.2 - 10.0 mm ²	16 - 8 AWG
0.2 - 10.0 mm ²	16 - 8 AWG
0.2 - 6.0 mm ²	16 - 10 AWG
0.2 - 6.0 mm ²	16 - 10 AWG

11 mm

IEC60947-7-2 UL-1059 CSA22.2-158 IEC 60079-7

1.6 Nm	14 lb-in	14 lb-in	1.2 Nm
0.5 Nm	4.5 lb-in	4.5 lb-in	



Polyamide 6,6 / 1

8 KV / 3

CGT16N



12 x 55 mm
48.5 mm / 56.0 mm

IEC	UL - CSA
0.2 - 16.0 mm ²	20 - 4 AWG
0.2 - 16.0 mm ²	20 - 4 AWG
0.2 - 10.0 mm ²	20 - 6 AWG
0.2 - 10.0 mm ²	20 - 6 AWG

12 mm

IEC60947-7-2 UL-1059 CSA22.2-158 IEC 60079-7

1.6 Nm	14 lb-in	14 lb-in	2.0 Nm
1.6 Nm	14 lb-in	14 lb-in	

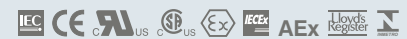

Polyamide 6,6 / 1

8 KV / 3

Type / Cat. No.	Standard Pack
CGT10N	50
CA701-1M / CA701-1M-S	50 m
CA701-15-1M / CA701-15-1M-S	25 m
CA509/K10WHT	100
MC10	10
SCS0.8/4 Blade size: 0.8 x 4 mm	10

Type / Cat. No.	Standard Pack
CGT10U	50
CA701-1M / CA701-1M-S	50 m
CA701-15-1M / CA701-15-1M-S	25 m
CA501-1M / CA501-1M-S	50 m
CA509/K10WHT	100
MC10	10
SCS0.8/4 Blade size: 0.8 x 4 mm	10

Type / Cat. No.	Standard Pack
CGT16N	50
CA701-1M / CA701-1M-S	50 m
CA701-15-1M / CA701-15-1M-S	25 m
CA509/K12WHT	100
MC12	10
SCS1.0/5.5 Blade size: 1.0 x 5.5 mm	10

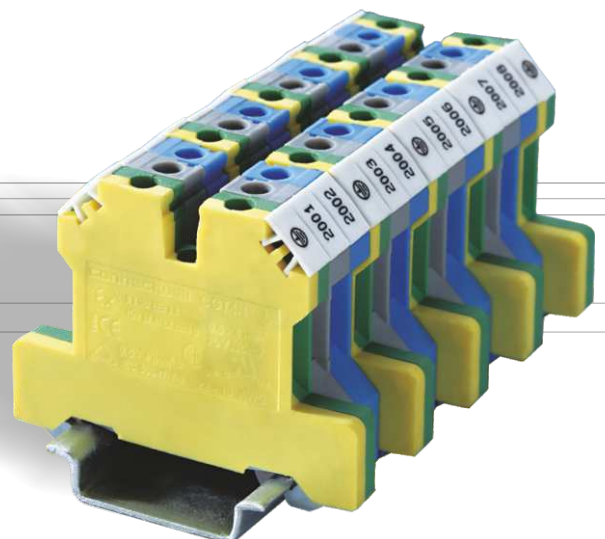

GROUND / EARTH TERMINAL BLOCKS

CGT35U



CGT50/70N

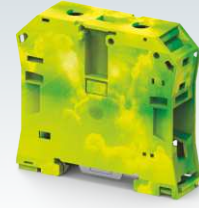

Width (Thickness) x Length	16 x 58 mm	
Height with DIN 35 x 7.5 / 35 x 15 / 32 mm Rail	63.2 mm / 70.5 mm / 68.0 mm	
Connection Possibility as per	IEC	UL - CSA
With 1 Conductor per clamp	Stranded / Flexible	2.5 - 35.0 mm ²
	Solid with Ferrule / Lug	2.5 - 35.0 mm ²
With 2 same size Conductors per clamp	Stranded / Flexible with TWIN Ferrule / Lug	2.5 - 25.0 mm ²
Wire Stripping Length	15 mm	
Ratings As Per	IEC60947-2	UL-1059 CSA22.2-158 IEC 60079-7
Torque	2.8 Nm	25 lb-in
Torque at Center Screw	1.2 Nm	10 lb-in
Approvals		
Insulation Material / Material Group	Polyamide 6,6 / 1	
Rated Impulse Voltage / Pollution Degree	8 KV / 3	

Width (Thickness) x Length	20 x 77 mm	
Height with DIN 35 x 7.5 / 35 x 15 / 32 mm Rail	71.1 mm / 78.1 mm	
Connection Possibility as per	IEC	UL - CSA
With 1 Conductor per clamp	Stranded / Flexible	10.0 - 70.0 mm ²
	Solid with Ferrule / Lug	10.0 - 70.0 mm ²
With 2 same size Conductors per clamp	Stranded / Flexible with TWIN Ferrule / Lug	10.0 - 35.0 mm ²
Wire Stripping Length	22 mm	
Ratings As Per	IEC60947-2	UL-1059 CSA22.2-158
Torque	3.0 Nm	38 lb-in
Torque at Center Screw	1.2 Nm	10 lb-in
Approvals		
Insulation Material / Material Group	Polyamide 6,6 / 1	
Rated Impulse Voltage / Pollution Degree	8 KV / 3	

Terminal Block	CGT35U	Standard Pack	20
Mounting Rail (Refer Pg. 263 for details)	CA701-1M / CA701-1M-S	50 m	
	CA701-15-1M / CA701-15-1M-S	25 m	
	CA501-1M / CA501-1M-S	50 m	
Marking Tags (Refer Pg. 268 for details)	CA509/K16WHT	100	
Marker Card (Refer Pg. 269 for details)	MC16	10	
Screw Driver	SCS1.0/5.5 Blade size: 1.0 x 5.5 mm	10	

Terminal Block	CGT50/70N CGT50/70NA	Standard Pack	20 20
Mounting Rail (Refer Pg. 263 for details)	CA701-1M / CA701-1M-S	50 m	
	CA701-15-1M / CA701-15-1M-S	25 m	
	CA501-1M / CA501-1M-S	50 m	
Marking Tags (Refer Pg. 268 for details)	CA509/K16WHT	100	
Marker Card (Refer Pg. 269 for details)	MC16	10	
Screw Driver	SCS1.0/5.5 Blade size: 1.0 x 5.5 mm	10	

Width (Thickness) x Length	20 x 77 mm	
Height with DIN 35 x 7.5 / 35 x 15 / 32 mm Rail	71.1 mm / 78.1 mm	
Connection Possibility as per	IEC	UL - CSA
With 1 Conductor per clamp	Stranded / Flexible	10.0 - 70.0 mm ²
	Solid with Ferrule / Lug	10.0 - 70.0 mm ²
With 2 same size Conductors per clamp	Stranded / Flexible with TWIN Ferrule / Lug	10.0 - 35.0 mm ²
Wire Stripping Length	22 mm	
Ratings As Per	IEC60947-2	UL-1059 CSA22.2-158
Torque	3.0 Nm	38 lb-in
Torque at Center Screw	1.2 Nm	10 lb-in
Approvals		
Insulation Material / Material Group	Polyamide 6,6 / 1	
Rated Impulse Voltage / Pollution Degree	8 KV / 3	

Terminal Block	CGT50/70N CGT50/70NA	Standard Pack	20 20
Mounting Rail (Refer Pg. 263 for details)	CA701-1M / CA701-1M-S	50 m	
	CA701-15-1M / CA701-15-1M-S	25 m	
	CA501-1M / CA501-1M-S	50 m	
Marking Tags (Refer Pg. 268 for details)	CA509/K16WHT	100	
Marker Card (Refer Pg. 269 for details)	MC16	10	
Screw Driver	SCS1.0/5.5 Blade size: 1.0 x 5.5 mm	10	

CGMT4



For DIN 15 Rail only

6 x 27 mm

30.7 mm (Height with DIN 15 Rail only)

IEC	UL - CSA
0.2 - 4.0 mm ²	22 - 10 AWG
0.2 - 6.0 mm ²	
0.2 - 4.0 mm ²	22 - 10 AWG
0.2 - 2.5 mm ²	22 - 12 AWG
0.2 - 2.5 mm ²	22 - 12 AWG

8 mm

IEC60947-7-2 UL-1059 CSA22.2-158 IEC 60079-7

0.8 Nm	7 lb-in	7 lb-in	0.5 Nm
0.4 Nm	3.6 lb-in	3.6 lb-in	



Polyamide 6,6 / 1

4 KV / 3

Type / Cat. No.	Standard Pack
CGMT4	100
CA601	100 m
CA509/K2WHT	100
MC2	10
SCS0.6/3.5 Blade size: 0.6 x 3.5 mm	10

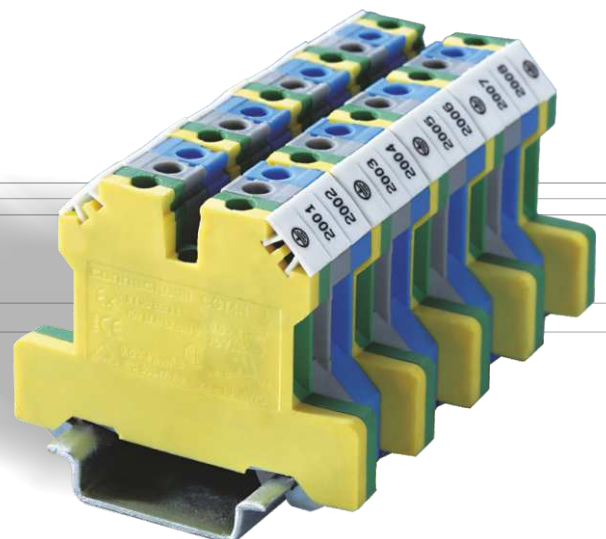

NEUTRAL / EARTH CLAMPS

The CENC series clamps are a flexible solution for terminating neutral and grounding wires on bus bar.

The NEB10 (10 x 3mm) and NEB6 (6 x 6mm) bus bar can either be panel mounted using Plastic supports NES or Din rail mounted using the end clamp CA202.

CENC4



Width (Thickness) x Length	7.5 x 23.3 mm			
Height with DIN 35 x 7.5 / 35 x 15 / 32 mm Rail				
Connection Possibility as per	IEC	UL - CSA		
With 1 Conductor per clamp	Stranded / Flexible	10.0 mm ²	22 - 12 AWG	
	Solid with Ferrule / Lug	10.0 mm ²	22 - 10 AWG	
With 2 same size Conductors per clamp	Stranded / Flexible	4.0 mm ²	22 - 14 AWG	
	with TWIN Ferrule / Lug	4.0 mm ²	22 - 14 AWG	
Wire Stripping Length	12 mm			
Ratings As Per	IEC60947-2	UL-1059	CSA22.2-158	
Voltage	800 V			
Current	57 A			
Torque	0.8 Nm	14 lb-in	14 lb-in	
Approvals				
Insulation Material / Material Group	Polyamide 6,6 / 1			
Rated Impulse Voltage / Pollution Degree	8 KV / 3			
	Type / Cat. No.	Standard Pack		
Terminal Block	Green	CENC4	50	
	Blue	CENC4BU	50	
	Black	CENC4BK	50	
	Grey	CENC4G	50	
Bus Bar 6 (H) x 6 (W) mm		NEB6	I _{max} : 140 A	10
Bus Bar 10(H) x 3 (W) mm		NEB10	I _{max} : 120 A	10
Plastic support with fixing screw		NES		50
Bus Bar Support for DIN 35 Rail Mounting		CA202		50
Marking Tags (Refer Pg. 268 for details)		CA509/K5WHT		100
Marker Card (Refer Pg. 269 for details)		MC5		10
Screw Driver		SCS0.8/4	Blade size: 0.8 x 4 mm	10

Note:
The current carrying capacity of the busbar (140A) should be taken into account while connecting loads.

PANEL & RAIL MOUNTING ASSEMBLY OF CENC CLAMPS

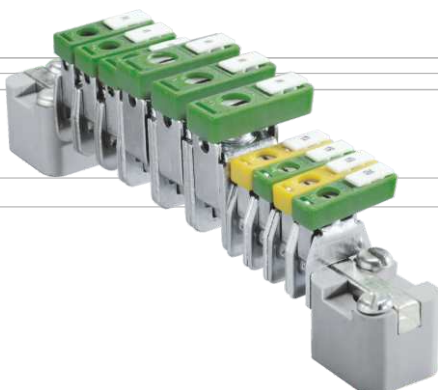

CENC16



9.8 x 23.3 mm

CENC35



14.5 x 27.3 mm

IEC	UL - CSA
10.0 - 16.0 mm ²	10 - 6 AWG
10.0 - 16.0 mm ²	10 - 6 AWG
6.0 - 10.0 mm ²	10 - 4 AWG
6.0 - 10.0 mm ²	10 - 4 AWG

16 mm

IEC60947-7-2 UL-1059 CSA22.2-158

800 V

76 A

2.0 Nm 17.5 lb-in 14 lb-in



Polyamide 6,6 / 1

8 KV / 3

Type / Cat. No.	Standard Pack
CENC16	50
CENC16BU	50
CENC16BK	50
CENC16G	50

NEB6 I_{max.}: 140 A 10

NEB10 I_{max.}: 120 A 10

NES 50

CA202 50

CA509/K6WHT 100

MC6 10

SCS1.0/5.5 Blade size: 1.0 x 5.5 mm 10

IEC	UL - CSA
10.0 - 35.0 mm ²	8 - 2 AWG
10.0 - 35.0 mm ²	8 - 2 AWG
10.0 - 25.0 mm ²	8 - 4 AWG
10.0 - 25.0 mm ²	8 - 4 AWG

16 mm

IEC60947-7-2 UL-1059 CSA22.2-158

800 V

125 A

2.5 Nm 25 lb-in 25 lb-in



Polyamide 6,6 / 1

8 KV / 3

Type / Cat. No.	Standard Pack
CENC35	50
CENC35BU	50
CENC35BK	50
CENC35G	50

NEB6 I_{max.}: 140 A 10

NEB10 I_{max.}: 120 A 10

NES 50

CA202 50

CA509/K6WHT 100

MC6 10

SCS1.0/5.5 Blade size: 1.0 x 5.5 mm 10

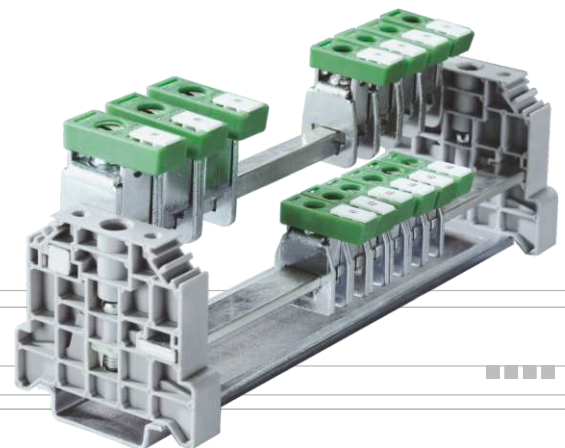

SCREW TYPE SHIELD CONNECTION CLAMPS

The screw type Shield connection clamps are available with Knurled Screw and suitable for mounting on 10 x 3 mm Busbar. These clamps can be easily used with the holder NES or NESCC.

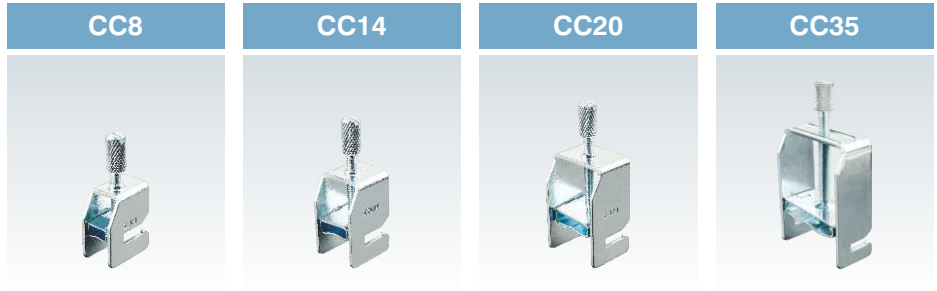

Type of Mounting

Bus bar mounting screw type shield connectors

Shield connection clamps for cable size
Ø8 mm, tightening torque 0.6 Nm
Ø14 mm, tightening torque 0.8 Nm
Ø20 mm, tightening torque 0.8 Nm
Ø35 mm, tightening torque 1.5 Nm

Type / Cat. No.	Standard Pack
CC8	10
CC14	10
CC20	10
CC35	10

Busbar 10(W) X 3(T) mm	NEB10 I _{max} : 120A	10
Mounting Support (Panel Mount)	NES	50
Mounting Support (Din 35 Rail Mounting)	NESCC	20

NEB10 I _{max} : 120A	10
NES	50
NESCC	20

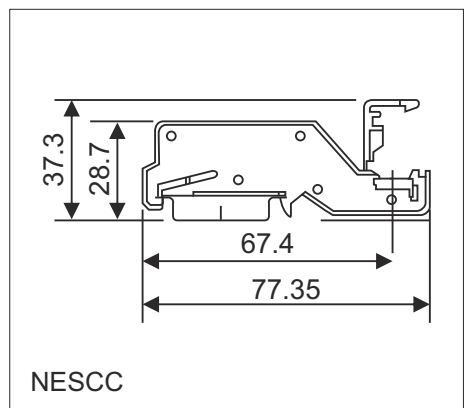
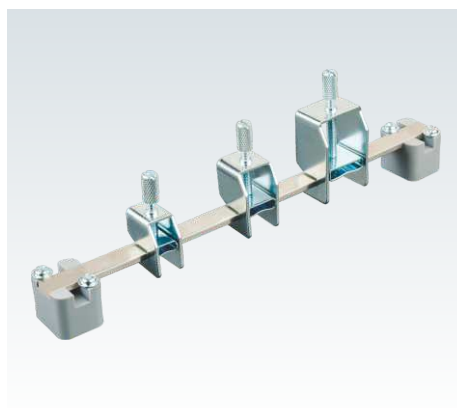
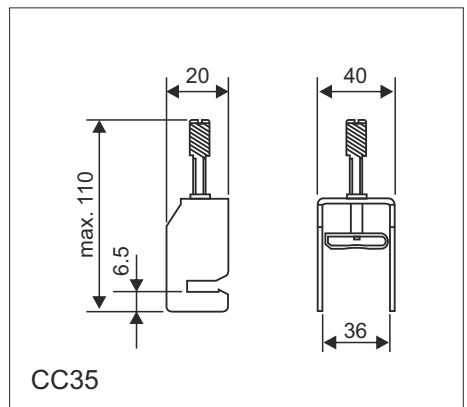
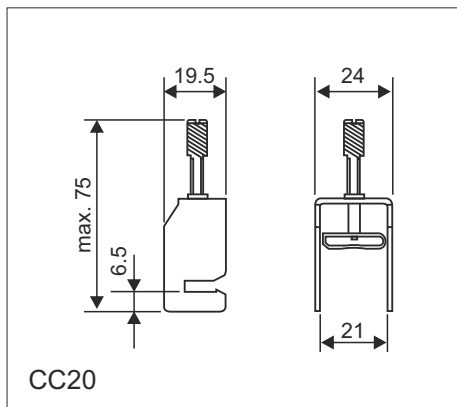
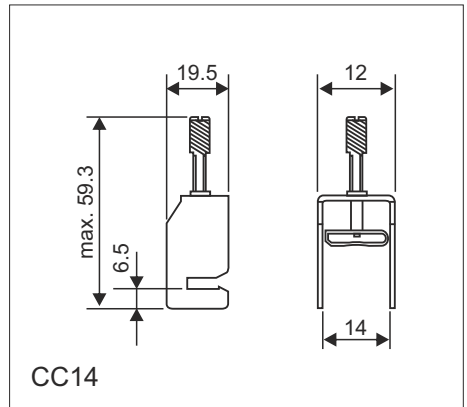
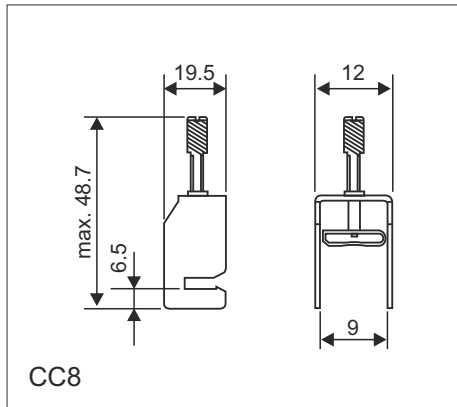

SPRING TYPE SHIELD CONNECTION CLAMPS

The electromagnetic compatibility of electrical machines and installations has become a very important aspect. Spring shield connection clamps CCS series are available in a wide range for cable and conductor sizes from diameters 2 to 32 mm.



Type of Mounting Bus bar mounting spring type shield connectors

Shield connection clamps for Busbar 10 X 3 mm		Type / Cat. No.	Standard Pack
Ø 2 - 6 mm		CCS2X2-6	10
Ø 3 - 8 mm		CCS3-8	10
Ø 4 - 13.5 mm		CCS4 -13.5	10
Ø 10 - 20 mm		CCS10-20	10
Ø 15 - 32 mm		CCS15-32	10
Busbar 10(W) X 3(T) mm		NEB10 I _{max} : 120A	10
Mounting Support (Panel Mount)		NES	50
Mounting Support (Din 35 Rail Mounting)		NESCC	20

Part No.	A	B	C
CCS 2X2 - 6	24	15	18.20
CCS 3 - 8	25.50	13.6	18.30
CCS 4 - 13.5	31	19.10	19.70
CCS 10 - 20	38.70	24.60	26.10
CCS 15 - 32	62.20	37.60	32.00

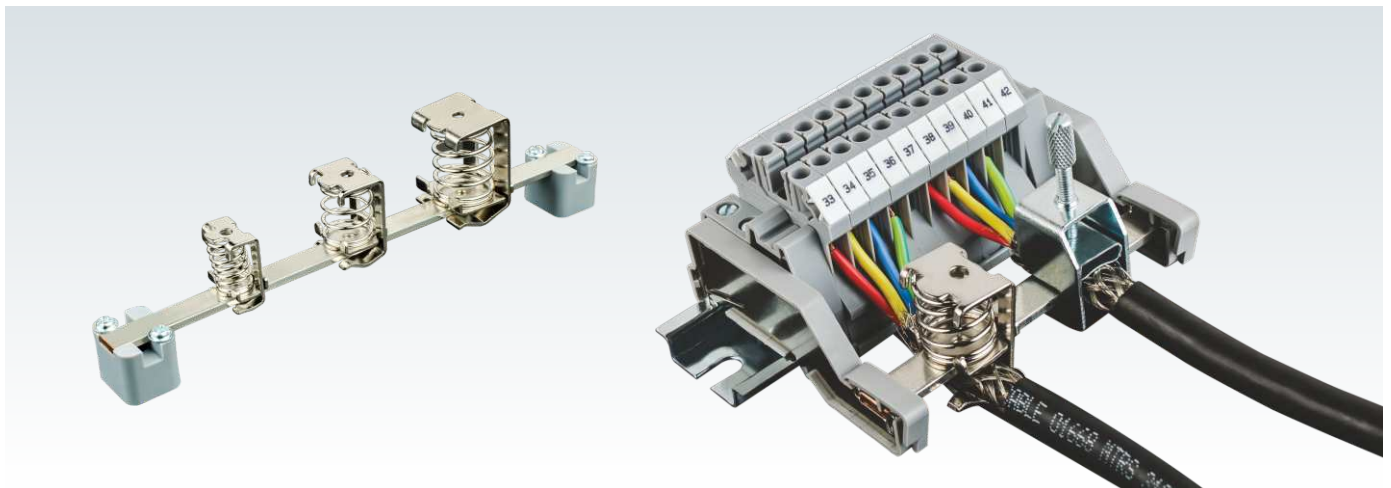
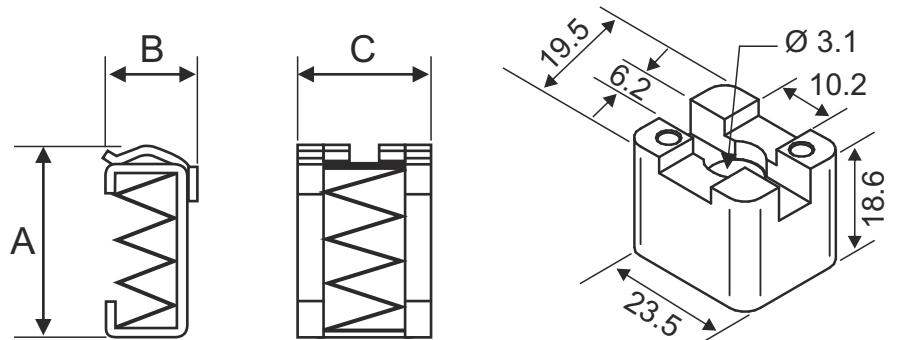

DOUBLE LEVEL FUSE TERMINAL BLOCKS

These blocks have a fuse carrier on the top level and a separate feed through terminal connection at the lower level. This eliminates the use of additional feed through Terminal Blocks.

DDFL4U(E) terminals have a specially designed built in circuit which gives light indication in the event of a fuse blow out at the top level.



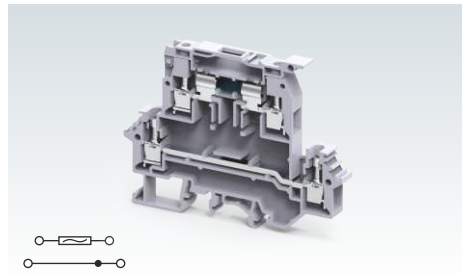

DDFL4ULR is a modified version of the DDFL4U Terminal Block where two equi-potential connection points are available on both sides of the Terminal Block.

The terminals with  & IECEx approval can be used in potentially explosive atmosphere. For detailed information refer page 289.

DDFL4U



Width (Thickness) x Length	8 x 88 mm		
Height with DIN 35 x 7.5 / 35 x 15 / 32 mm Rail	67.4 mm / 74.3 mm / 71.4 mm		
Connection Possibility as per	IEC	UL - CSA	
With 1 Conductor per clamp	Stranded / Flexible	0.2 - 4.0 mm ²	22 - 10 AWG
	Solid	0.2 - 6.0 mm ²	
	with Ferrule / Lug	0.2 - 4.0 mm ²	22 - 10 AWG
With 2 same size Conductors per clamp	Stranded / Flexible	0.2 - 2.5 mm ²	22 - 12 AWG
	with TWIN Ferrule / Lug	0.2 - 2.5 mm ²	22 - 12 AWG
Wire Stripping Length	9.5 mm		
Ratings As Per	IEC60947-7-3	UL-1059	CSA22.2-158
Voltage	800 V	600 V	600 V
Current	Top Level	6.3 A	6.3 A
	Bottom Level	32 A	35 A
Torque	0.5 Nm	7 lb-in	7 lb-in
Approvals			
Insulation Material / Material Group	Polyamide 6,6 / 1		
Rated Impulse Voltage / Pollution Degree	8 kV / 3		
Fuse Size	Ø5 x 20, Ø5 x 25 mm		

		Type / Cat. No.	Standard Pack
Terminal Block	Grey	DDFL4UW/F	20
	With LED for 6 - 60 V AC/DC	DDFL4UE6-60V	20
	With LED for 110 - 240 V AC/DC	DDFL4UE110-240V	20
	With LED for 24 V AC/DC	DDFL4UE24V	20
	With LED for 48 V AC/DC	DDFL4UE48V	20
	With LED for 110 V AC/DC	DDFL4UE110V	20
	With LED for 220 V AC/DC	DDFL4UE220V	20
	With LED for 440 V AC	DDFL4UE440V	20
End Plate		EPDDFL4U	50
Mounting Rail (Refer Pg. 263 for details)		CA701-1M / CA701-1M-S	50 m
		CA701-15-1M / CA701-15-1M-S	25 m
End Clamp (Refer Pg. 264 for details)		CA702 / CA802 / CA202	50
Marking Tags	On Terminal	CA509/K8WHT	100
	Continuous Tag	CA509/K2WHT	100
Marker Card	On Terminal	MC8	10
	Continuous Tag	MC2	10
Screw Driver		SCS0.6/3.5 Blade size: 0.6 x 3.5 mm	10

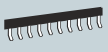
Jumpers		Uninsulated	Insulated	I _{max}	Standard Pack
Screw Type Jumpers		CA729/2	CA749/2	32 A	100
		CA729/3	CA749/3	32 A	50
		CA729/4	CA749/4	32 A	50
		CA729/10	CA749/10	32 A	10
External Jumpers			CA711/2	32 A	100
			CA711/3	32 A	50
			CA711/4	32 A	50
			CA711/10	32 A	20

DDFL4ULR

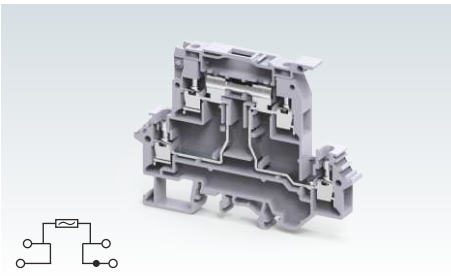

8 x 88 mm

67.4 mm / 74.3 mm / 71.4 mm

IEC	UL - CSA
0.2 - 4.0 mm ²	22 - 10 AWG
0.2 - 6.0 mm ²	
0.2 - 4.0 mm ²	22 - 10 AWG
0.2 - 2.5 mm ²	22 - 12 AWG
0.2 - 2.5 mm ²	22 - 12 AWG

9.5 mm

IEC60947-7-3 UL-1059 CSA22.2-158

800 V	600 V	600 V	
6.3 A	6.3 A	6.3 A	

0.5 Nm	7 lb-in	7 lb-in	
--------	---------	---------	--



Polyamide 6,6 / 1

8 KV / 3

Ø5 x 20, Ø5 x 25 mm

Type / Cat. No.	Standard Pack
DDFL4ULRW/F	20
DDFL4UELR24V	20
DDFL4UELR48V	20
DDFL4UELR110V	20
DDFL4UELR220V	20
DDFL4UELR440V	20
EPDDFL4U	50
CA701-1M / CA701-1M-S	50 m
CA701-15-1M / CA701-15-1M-S	25 m
CA702 / CA802 / CA202	50
CA509/K8WHT	100
CA509/K2WHT	100
MC8	10
MC2	10
SCS0.6/3.5 Blade size: 0.6 x 3.5 mm	10

Uninsulated	Insulated	I _{max}	Standard Pack
CA729/2	CA749/2	32 A	100
CA729/3	CA749/3	32 A	50
CA729/4	CA749/4	32 A	50
CA729/10	CA749/10	32 A	10
CA711/2		32 A	100
CA711/3		32 A	50
CA711/4		32 A	50
CA711/10		32 A	20

DISCONNECT & TEST TERMINAL BLOCKS

These blocks are used for measuring, control and regulatory circuits.

In CKT4U & CKT4U/4 disconnection is achieved by lifting a lever which operates the knife contact.

Specially designed socket headed screws act as receptacles for test probes in these Terminal Blocks.

CKT4U/S is another version of CKT4U Terminal Block in which regular slotted screws are used.

CKT4SP terminal provides a possibility of using screw type jumpers for cross connection.

CF4SPFT feed through terminals have the same profile as that of the CF4SP and CKT4SP Terminal Block.

CKT4SP series terminal are completely closed and do not need a separate end plate.

CKT6U terminals have the same outer profile of CTS6U feed through terminals.





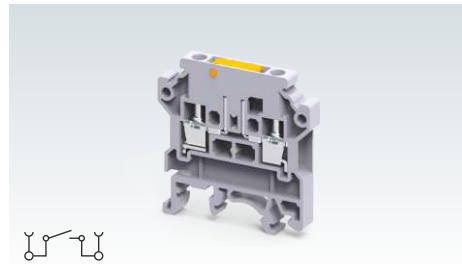

CKT4UH & CKT6U terminals have an extended tab on the disconnecting blade which facilitates tool less operation of the disconnecting contact.

CKT6U terminal has the same profile as that of CTS6U & CTS10U feed through terminals.

The terminals with  & IECEx approval can be used in potentially explosive atmosphere. For detailed information refer page 289.

CKT4U



Width (Thickness) x Length		6 x 46.3 mm			
Height with DIN 35 x 7.5 / 35 x 15 / 32 mm Rail		48.3 mm / 56.0 mm / 54.5 mm			
Connection Possibility as per		IEC		UL - CSA	
With 1 Conductor per clamp	Stranded / Flexible	0.2 - 4.0 mm ²		22 - 10 AWG	
	Solid with Ferrule / Lug	0.2 - 6.0 mm ²		22 - 10 AWG	
With 2 same size Conductors per clamp	Stranded / Flexible	0.2 - 4.0 mm ²		22 - 10 AWG	
	with TWIN Ferrule / Lug	0.2 - 2.5 mm ²		22 - 12 AWG	
Wire Stripping Length		8 mm			
Ratings As Per		IEC60947-7-1 UL-1059 CSA22.2-158			
Voltage		800 V	600 V	600 V	
Current		28 A	35 A	16 A	
Torque		0.5 Nm	7 lb-in	7 lb-in	
Approvals					
Insulation Material / Material Group		Polyamide 6,6 / 1			
Rated Impulse Voltage / Pollution Degree		8 KV / 3			
		Type / Cat. No.		Standard Pack	
Terminal Block	With Standard Slotted Screw	CKT4U/S		50	
	With Socket Headed Screw - Grey	CKT4U		50	
	With Socket Headed Screw - Blue	CKT4UBU		50	
	Disconnecting knife with Pull Tab	CKT4UH		50	
End Plate 		EPCKT4U		50	
Mounting Rail (Refer Pg. 263 for details) 		CA701-1M / CA701-1M-S		50 m	
		CA701-15-1M / CA701-15-1M-S		25 m	
End Clamp (Refer Pg. 264 for details) 		CA702 / CA802		50	
Marking Tags (Refer Pg. 268 for details) 		CA509/K6WHT		100	
Marker Card (Refer Pg. 269 for details)		MC6		10	
Screw Driver 		SCS0.6/3.5 Blade size: 0.6 x 3.5 mm		10	
Jumpers		Uninsulated		Insulated	
				Imax	
				Standard Pack	
Screw Type Jumpers 	2 pole				
	3 pole				
	4 pole				
	10 pole				
External Jumpers 	2 pole	CA714/2		32 A 100	
	3 pole	CA714/3		32 A 100	
	4 pole	CA714/4		32 A 100	
	10 pole	CA714/10		32 A 20	

CKT4U/4

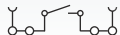

6 x 65 mm

54.3 mm / 62.0 mm / 60.5 mm

IEC	UL - CSA
0.2 - 4.0 mm ²	22 - 10 AWG
0.2 - 6.0 mm ²	
0.2 - 4.0 mm ²	22 - 10 AWG
0.2 - 2.5 mm ²	22 - 12 AWG
0.2 - 2.5 mm ²	22 - 12 AWG

8 mm

IEC60947-7-1 UL-1059 CSA22.2-158

800 V	600 V	600 V
17.5 A	20 A	20 A
0.5 Nm	7 lb-in	7 lb-in



Polyamide 6,6 / 1

8 KV / 3

Type / Cat. No.	Standard Pack
CKT4U/4*	50
CKT4U/4BU	50

EPCKT4U/4	50
CA701-1M / CA701-1M-S	50 m
CA701-15-1M / CA701-15-1M-S	25 m
CA702 / CA802	50
CA509/K6WHT	100
MC6	10
SCS0.6/3.5 Blade size: 0.6 x 3.5 mm	10

Uninsulated	Insulated	I _{max}	Standard Pack
	CA714/2 [#]	32 A	100
	CA714/3 [#]	32 A	100
	CA714/4 [#]	32 A	100
	CA714/10 [#]	32 A	20

CKT4SP

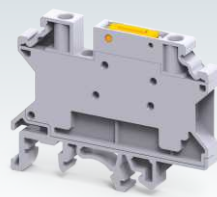

6 x 58.5 mm

46.0 mm / 53.5 mm / 51.5 mm

IEC	UL - CSA
0.2 - 4.0 mm ²	24 - 10 AWG
0.2 - 6.0 mm ²	
0.2 - 4.0 mm ²	24 - 10 AWG
0.2 - 2.5 mm ²	24 - 12 AWG
0.2 - 2.5 mm ²	24 - 12 AWG

8 mm

IEC60947-7-1 UL-1059 CSA22.2-158

1000 V	600 V	600 V
28 A	30 A	30 A
0.5 Nm	4.5 lb-in	4.5 lb-in



Polyamide 6,6 / 1

8 KV / 3

Type / Cat. No.	Standard Pack
CKT4SP	50
CKT4SPBU	50

CA701-1M / CA701-1M-S	50 m
CA701-15-1M / CA701-15-1M-S	25 m
CA702 / CA802	50
CA509/K6WHT	100
MC6	10
SCS0.6/3.5 Blade size: 0.6 x 3.5 mm	10

Uninsulated	Insulated	I _{max}	Standard Pack
CA722/2	CA742/2	32 A	100
CA722/3	CA742/3	32 A	100
CA722/4	CA742/4	32 A	100
CA722/10	CA742/10	32 A	10
	CA714/2	32 A	100
	CA714/3	32 A	100
	CA714/4	32 A	100
	CA714/10	32 A	20

CF4SPFT

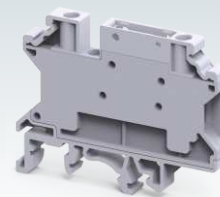

6 x 58.5 mm

46.0 mm / 53.5 mm / 51.5 mm

IEC	UL - CSA
0.2 - 4.0 mm ²	24 - 10 AWG
0.2 - 6.0 mm ²	
0.2 - 4.0 mm ²	24 - 10 AWG
0.2 - 2.5 mm ²	24 - 12 AWG
0.2 - 2.5 mm ²	24 - 12 AWG

8 mm

IEC60947-7-1 UL-1059 CSA22.2-158

1000 V	600 V	600 V
32 A	30 A	30 A
0.5 Nm	4.5 lb-in	4.5 lb-in



Polyamide 6,6 / 1

8 KV / 3

Type / Cat. No.	Standard Pack
CF4SPFT	50
CF4SPFTBU	50

CA701-1M / CA701-1M-S	50 m
CA701-15-1M / CA701-15-1M-S	25 m
CA702 / CA802	50
CA509/K6WHT	100
MC6	10
SCS0.6/3.5 Blade size: 0.6 x 3.5 mm	10

Uninsulated	Insulated	I _{max}	Standard Pack
CA722/2	CA742/2	32 A	100
CA722/3	CA742/3	32 A	100
CA722/4	CA742/4	32 A	100
CA722/10	CA742/10	32 A	10
	CA714/2	32 A	100
	CA714/3	32 A	100
	CA714/4	32 A	100
	CA714/10	32 A	20

* CKT4U/4 Terminal has standard screws on the upper level clamps and socket screws on the lower level clamps.

External Jumpers can be used only in the upper level clamping unit of the Terminal Block.

CKT6U



Width (Thickness) x Length	8 x 42.5 mm	
Height with DIN 35 x 7.5 / 35 x 15 / 32 mm Rail	51.2 mm / 58.7 mm / 56.1 mm	
Connection Possibility as per	IEC	UL - CSA
With 1 Conductor per clamp	Stranded / Flexible	0.5 - 6.0 mm ²
	Solid	22 - 8 AWG
With 2 same size Conductors per clamp	with Ferrule / Lug	0.5 - 6.0 mm ²
	Stranded / Flexible with TWIN Ferrule / Lug	0.5 - 2.5 mm ²
		22 - 12 AWG
Wire Stripping Length	8 mm	
Ratings As Per	IEC60947-7-1	
Voltage	1000 V	
Current	41 A	
Torque	0.8 Nm	
Approvals	CE	
Insulation Material / Material Group	Polyamide 6,6 / 1	
Rated Impulse Voltage / Pollution Degree	8 KV / 3	

		Type / Cat. No.	Standard Pack	
Terminal Block	Grey	CKT6U	50	
	Blue	CKT6UBU	50	
End Plate		EP6/10U	50	
Mounting Rail (Refer Pg. 263 for details)		CA701-1M / CA701-1M-S	50 m	
		CA701-15-1M / CA701-15-1M-S	25 m	
End Clamp (Refer Pg. 264 for details)		CA702 / CA802	50	
Marking Tags (Refer Pg. 268 for details)		CA509/K8WHT	100	
Marker Card (Refer Pg. 269 for details)		MC8	10	
Screw Driver		SCS0.8/4 Blade size: 0.8 x 4 mm	10	
Jumpers		Insulated	Imax	Standard Pack
External Jumpers	2 pole	CA710/2	41 A	100
	3 pole	CA710/3	41 A	50
	4 pole	CA710/4	41 A	50
	10 pole	CA710/10	41 A	20

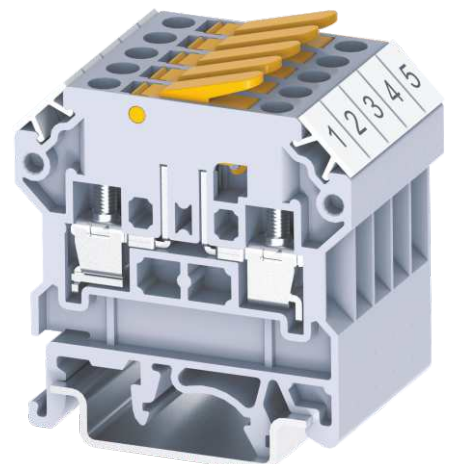

CKT4UH Terminals

CERTIFICATIONS & APPROVALS



is an ISO 9001:2008 Company with products and systems approved by various credible third party organizations



Cert. No.: 44 100 990789/01-E3
TUV NORD



VDE Testing & Certification Institute



Underwriters Laboratories Inc



Canadian Standards Association



ATEX - IECEX
Installation instruction refer page 243-247



(IECEE) CB Scheme



(IECEE) CE Scheme



STQC Certification Services



DISCONNECT & TEST TERMINAL BLOCKS

These blocks are used for measuring, control and regulatory circuits. They provide a clear functional advantage for devices having utility instruments and associated transformers.

In CDTTU & CDTTUSH disconnection is achieved by means of a slide link operated with a screw driver.

Specially designed socket headed screws act as receptacles for test probes in Disconnecting & Test Terminal Blocks.

CDTTUFT is a standard feed through terminal with the same profile as that of CDTTU.

CDTTU

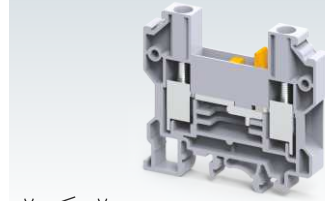

Width (Thickness) x Length		8 x 63 mm			
Height with DIN 35 x 7.5 / 35 x 15 / 32 mm Rail		58.7 mm / 65.7 mm / 63.7 mm			
Connection Possibility as per		IEC	UL - CSA		
With 1 Conductor per clamp	Stranded / Flexible	1.5 - 6.0 mm ²	16 - 8 AWG		
	Solid with Ferrule / Lug	1.5 - 6.0 mm ²	16 - 8 AWG		
With 2 same size Conductors per clamp	Stranded / Flexible	1.5 - 4.0 mm ²	16 - 10 AWG		
	with TWIN Ferrule / Lug	1.5 - 4.0 mm ²	16 - 10 AWG		
Wire Stripping Length		12 mm			
Ratings As Per		IEC60947-7-1	UL-1059	CSA22.2-158	
Voltage		800 V	600 V	600 V	
Current		41 A	41 A	41 A	
Torque		1.2 Nm	14 lb-in	14 lb-in	
Approvals					
Insulation Material / Material Group		Polyamide 6,6 / 1			
Rated Impulse Voltage / Pollution Degree		8 KV / 3			
		Type / Cat. No.	Standard Pack		
Terminal Block	Grey Blue	CDTTU	50		
		CDTTUBU	50		
End Plate		EPCDTTU	50		
Mounting Rail (Refer Pg. 263 for details)		CA701-1M / CA701-1M-S	50 m		
		CA701-15-1M / CA701-15-1M-S	25 m		
End Clamp (Refer Pg. 264 for details)		CA702 / CA802	50		
Marking Tags (Refer Pg. 268 for details)		CA509/K8WHT	100		
Marker Card (Refer Pg. 269 for details)		MC8	10		
Screw Driver		SCS1.0/5.5 Blade size: 1.0 x 5.5 mm	10		
Jumpers		Type / Cat. No.	I_{max}	Standard Pack	
External Jumpers		2 pole	CA710/2	35 A	100
		3 pole	CA710/3	35 A	50
		4 pole	CA710/4	35 A	50
		10 pole	CA710/10	35 A	20
Shorting Plug		2 pole	QJ8/2		25

CDTTUSH

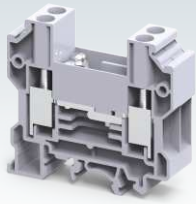

16 x 63 mm

58.7 mm / 65.7 mm / 63.7 mm

IEC	UL - CSA
1.5 - 6.0 mm ²	16 - 8 AWG
1.5 - 6.0 mm ²	16 - 8 AWG
1.5 - 4.0 mm ²	16 - 10 AWG
1.5 - 4.0 mm ²	16 - 10 AWG

12 mm

IEC60947-7-1 UL-1059 CSA22.2-158

160 V	300 V	300 V
10 A	25 A	25 A
1.2 Nm	14 lb-in	14 lb-in



Polyamide 6,6 / 1

2.5 KV / 3

Type / Cat. No.	Standard Pack
CDTTUSH	20
EPCDTTU	50
CA701-1M / CA701-1M-S	50 m
CA701-15-1M / CA701-15-1M-S	25 m
CA702 / CA802	50
CA509/K8WHT	100
MC8	10
SCS1.0/5.5 Blade size: 1.0 x 5.5 mm	10

Type / Cat. No.	I _{max}	Standard Pack
CA710/2	35 A	100
CA710/3	35 A	50
CA710/4	35 A	50
CA710/10	35 A	20
QJ8/2		25

CDTTUFT

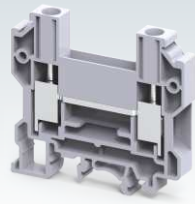

8 x 63 mm

58.7 mm / 65.7 mm / 63.7 mm

IEC	UL - CSA
1.5 - 10.0 mm ²	16 - 8 AWG
1.5 - 10.0 mm ²	16 - 8 AWG
1.5 - 4.0 mm ²	16 - 10 AWG
1.5 - 4.0 mm ²	16 - 10 AWG

12 mm

IEC60947-7-1 UL-1059 CSA22.2-158

800 V	600 V	600 V
57 A	41 A	41 A
1.2 Nm	14 lb-in	14 lb-in



Polyamide 6,6 / 1

8 KV / 3

Type / Cat. No.	Standard Pack
CDTTUFT	50
CDTTUFTBU	50
EPCDTTU	50
CA701-1M / CA701-1M-S	50 m
CA701-15-1M / CA701-15-1M-S	25 m
CA702 / CA802	50
CA509/K8WHT	100
MC8	10
SCS1.0/5.5 Blade size: 1.0 x 5.5 mm	10

Type / Cat. No.	I _{max}	Standard Pack
CA710/2	35 A	100
CA710/3	35 A	50
CA710/4	35 A	50
CA710/10	35 A	20
QJ8/2		25

DISCONNECT & TEST TERMINAL BLOCKS

The CDS6U Disconnect & Test Terminal Block is used for measuring, control and regulatory circuits. They provide a clear functional advantage for devices having utility instruments and associated transformers.

Separate testing points facilitate insertion of test probes. Disconnection is achieved by means of a slide link operated with a Screw Driver.

In the CDS6U/TS, the insulated test point screw system (TPSLS) is integrated.

CDS6U/FT Terminal Block is a standard feed through Terminal Block.

The SLS2 and SLS4 sliding jumpers can be used in combination with either the supplied screw or the TPSLS Test point screw system.

Lock out cap LCCDS can be used to lock the center shorting screw, to prevent accidental opening of circuits.

CDS4U

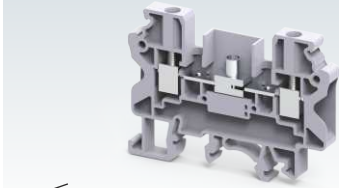

Width (Thickness) x Length		6 x 62.6 mm			
Height with DIN 35 x 7.5 / 35 x 15 / 32 mm Rail		45.2 mm / 52.7 mm / 50.2 mm			
Connection Possibility as per		IEC		UL - CSA	
With 1 Conductor per clamp	Stranded / Flexible	0.2 - 4.0 mm ²		24 - 10 AWG	
	Solid with Ferrule / Lug	0.2 - 6.0 mm ²		24 - 10 AWG	
With 2 same size Conductors per clamp	Stranded / Flexible	0.2 - 4.0 mm ²		24 - 10 AWG	
	with TWIN Ferrule / Lug	0.2 - 2.5 mm ²		14 - 4 AWG	
Wire Stripping Length		8 mm			
Ratings As Per		IEC60947-7-1 UL-1059			
Voltage		800 V	600 V		
Current		32 A	28 A		
Torque		0.5 Nm	7 lb-in		
Approvals		CE			
Insulation Material / Material Group		Polyamide 6,6 / 1			
Rated Impulse Voltage / Pollution Degree		8 KV / 3			
		Type / Cat. No.		Standard Pack	
Terminal Block		Grey CDS4U		50	
End Plate		EPCDS4U		50	
Mounting Rail (Refer Pg. 263 for details)		CA701-1M / CA701-1M-S		50 m	
		CA701-15-1M / CA701-15-1M-S		25 m	
End Clamp (Refer Pg. 264 for details)		CA702 / CA802		50	
Marking Tags (Refer Pg. 268 for details)		CA509/K6WHT		100	
Marker Card (Refer Pg. 269 for details)		MC6		10	
Screw Driver		SCS0.6/3.5 Blade size: 0.6 x 3.5 mm		10	
Jumpers		Uninsulated	Insulated	Imax	Standard Pack
Screw Type Jumpers	2 pole	CA722/2	CA742/2	32 A	100
	3 pole	CA722/3	CA742/3	32 A	100
	4 pole	CA722/4	CA742/4	32 A	100
	10 pole	CA722/10	CA742/10	32 A	10
	100 pole	CA722/100	CA742/100	32 A	10
Configurable Jumper Bar	2 pole	CA703/1		32 A	100
	3 pole	CA704/1		32 A	100
	4 pole	CA705/1		32 A	100
	10 pole	CA732/10		32 A	100
	10 pole (Breakable)	CA732/10-A		32 A	100
	100 pole	CA732/100		32 A	10
Short Sleeve & Screw for configurable jumper bar		CA707/S/Q/01		100	
Switchable Jumpers		CA706/1		32A 100	
Long Sleeve & Screw for Switchable Jumpers		CA707/L/Q/01		100	
External Jumpers	2 pole		CA713/2	30 A	100
	3 pole		CA713/3	30 A	100
	4 pole		CA713/4	30 A	100
	10 pole		CA713/10	30 A	20
Test Socket		CA707/TS/01		100	

CDS6U

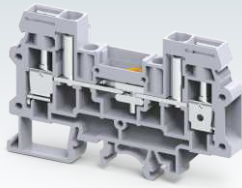

8 x 82 mm

51.0 mm / 59.2 mm / 56.7 mm

IEC	UL - CSA
0.2 - 6.0 mm ²	22 - 8 AWG
0.2 - 6.0 mm ²	22 - 8 AWG
0.2 - 4.0 mm ²	22 - 10 AWG
0.2 - 4.0 mm ²	22 - 10 AWG

10 mm

IEC60947-7-1 UL-1059 CSA22.2-158

800 V	600 V	600 V
41 A	45 A	45 A
0.8 Nm	14 lb-in	14 lb-in



Polyamide 6,6 / 1

8 KV / 3

Type / Cat. No.	Standard Pack	
CDS6U	50	
CDS6UBU	50	
EPCDS6U	50	
CA701-1M / CA701-1M-S	50 m	
CA701-15-1M / CA701-15-1M-S	25 m	
CA702 / CA802	50	
CA509/K8WHT	100	
MC8	10	
SCS0.8/4 Blade size: 0.8 x 4 mm	10	
Type / Cat. No.	Imax	Standard Pack
CA723/2	41 A	100
CA723/3	41 A	50
CA723/4	41 A	50
CA723/5	41 A	50
CA723/6	41 A	10
CA723/10	41 A	10
SLS2	35 A	50
SLS3	35 A	25
SLS4	35 A	25
TPSLS		50
TPSLSR		50
TPSLSY		50
TPSLSBU		50
TPSLSBK		50
SWCDS	35 A	50
LCCDS		50
QJ8/2		25

CDS6U/TS

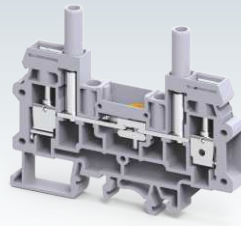

8 x 82 mm

51.0 mm / 59.2 mm / 56.7 mm

IEC	UL - CSA
0.2 - 6.0 mm ²	22 - 8 AWG
0.2 - 6.0 mm ²	22 - 8 AWG
0.2 - 4.0 mm ²	22 - 10 AWG
0.2 - 4.0 mm ²	22 - 10 AWG

10 mm

IEC60947-7-1 UL-1059 CSA22.2-158

630 V	600 V	600 V
41 A	45 A	45 A
0.8 Nm	14 lb-in	14 lb-in



Polyamide 6,6 / 1

8 KV / 3

Type / Cat. No.	Standard Pack	
CDS6U/TS	50	
EPCDS6U	50	
CA701-1M / CA701-1M-S	50 m	
CA701-15-1M / CA701-15-1M-S	25 m	
CA702 / CA802	50	
CA509/K8WHT	100	
MC8	10	
SCS0.8/4 Blade size: 0.8 x 4 mm	10	
Type / Cat. No.	Imax	Standard Pack
CA723/2	41 A	100
CA723/3	41 A	50
CA723/4	41 A	50
CA723/5	41 A	50
CA723/6	41 A	10
CA723/10	41 A	10
SLS2	35 A	50
SLS3	35 A	25
SLS4	35 A	25
SWCDS	35 A	50
LCCDS		50
QJ8/2		25

CDS6U/FT

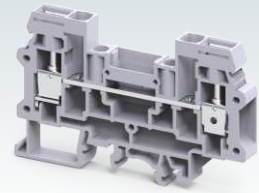

8 x 82 mm

51.0 mm / 59.2 mm / 56.7 mm

IEC	UL - CSA
0.2 - 6.0 mm ²	22 - 8 AWG
0.2 - 6.0 mm ²	22 - 8 AWG
0.2 - 4.0 mm ²	22 - 10 AWG
0.2 - 4.0 mm ²	22 - 10 AWG

10 mm

IEC60947-7-1 UL-1059 CSA22.2-158

1000 V	600 V	600 V
41 A	45 A	45 A
0.8 Nm	14 lb-in	14 lb-in



Polyamide 6,6 / 1

8 KV / 3

Type / Cat. No.	Standard Pack	
CDS6U/FT	50	
EPCDS6U	50	
CA701-1M / CA701-1M-S	50 m	
CA701-15-1M / CA701-15-1M-S	25 m	
CA702 / CA802	50	
CA509/K8WHT	100	
MC8	10	
SCS0.8/4 Blade size: 0.8 x 4 mm	10	
Type / Cat. No.	Imax	Standard Pack
CA723/2	41 A	100
CA723/3	41 A	50
CA723/4	41 A	50
CA723/5	41 A	50
CA723/6	41 A	10
CA723/10	41 A	10
SWCDS	35 A	50

DISCONNECT & TEST TERMINAL BLOCKS

CDS6U/SC Disconnect & Test Terminal Block, an additional safety spring is provided underneath the screw clamp. These Terminal Blocks are preferred for connections that involve safety requirements of the Electric Supply Industry (ESI) standards, British CEBG regulations and NTPC applications.

The SLS2 and SLS4 sliding jumpers can be used in combination with either the supplied screw or the TPSLS Test point screw system.

Lock out cap LCCDS can be used to lock the center shorting screw, to prevent accidental opening of circuits.

CDS6U/SC

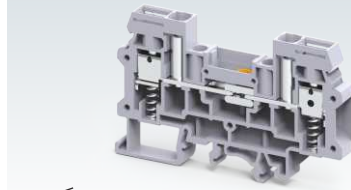

Width (Thickness) x Length		8 x 82 mm			
Height with DIN 35 x 7.5 / 35 x 15 / 32 mm Rail		51.0 mm / 59.2 mm / 56.7 mm			
Connection Possibility as per		IEC		UL - CSA	
With 1 Conductor per clamp	Stranded / Flexible	0.2 - 6.0 mm ²		22 - 8 AWG	
	Solid with Ferrule / Lug	0.2 - 6.0 mm ²		22 - 8 AWG	
With 2 same size Conductors per clamp	Stranded / Flexible	0.2 - 4.0 mm ²		22 - 10 AWG	
	with TWIN Ferrule / Lug	0.2 - 4.0 mm ²		22 - 10 AWG	
Wire Stripping Length		10 mm			
Ratings As Per		IEC60947-7-1	UL-1059	CSA22.2-158	
Voltage		800 V	600 V	600 V	
Current		41 A	45 A	45 A	
Torque		0.8 Nm	14 lb-in	14 lb-in	
Approvals					
Insulation Material / Material Group		Polyamide 6,6 / 1			
Rated Impulse Voltage / Pollution Degree		8 KV / 3			
		Type / Cat. No.		Standard Pack	
Terminal Block	Grey Blue	CDS6U/SC		50	
End Plate		EPCDS6U		50	
Mounting Rail (Refer Pg. 263 for details)		CA701-1M / CA701-1M-S		50 m	
		CA701-15-1M / CA701-15-1M-S		25 m	
End Clamp (Refer Pg. 264 for details)		CA702 / CA802		50	
Marking Tags (Refer Pg. 268 for details)		CA509/K8WHT		100	
Marker Card (Refer Pg. 269 for details)		MC8		10	
Screw Driver		SCS0.8/4 Blade size: 0.8 x 4 mm		10	
Jumpers		Type / Cat. No.		I_{max}	Standard Pack
Screw Type Jumpers		2 pole		CA723/2	100
		3 pole		CA723/3	50
		4 pole		CA723/4	50
		5 pole		CA723/5	50
		6 pole		CA723/6	10
		10 pole		CA723/10	10
Sliding Jumpers		2 Pole		SLS2	50
		3 Pole		SLS3	25
		4 Pole		SLS4	25
Insulated Test Socket		Grey		TPSLS	50
		Red		TPSLSR	50
		Yellow		TPSLSY	50
		Blue		TPSLSBU	50
		Black		TPSLSBK	50
Switchable Jumpers		SWCDS		35 A	50
Lock Out Cap		LCCDS			50
Shorting Plug		2 pole		QJ8/2	25

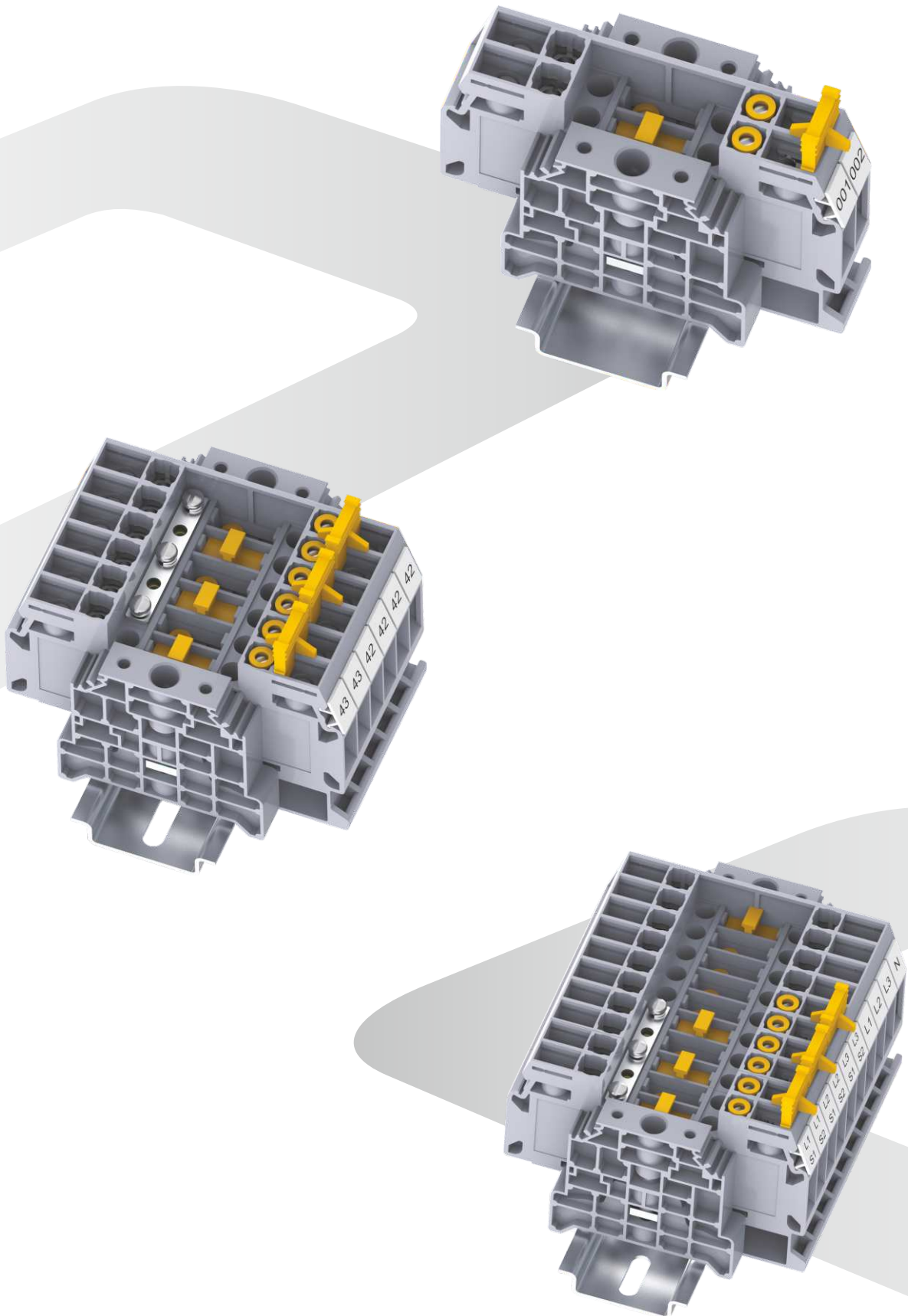

Usage of CDS6U range of products in Simple Current Transformer Test Circuit

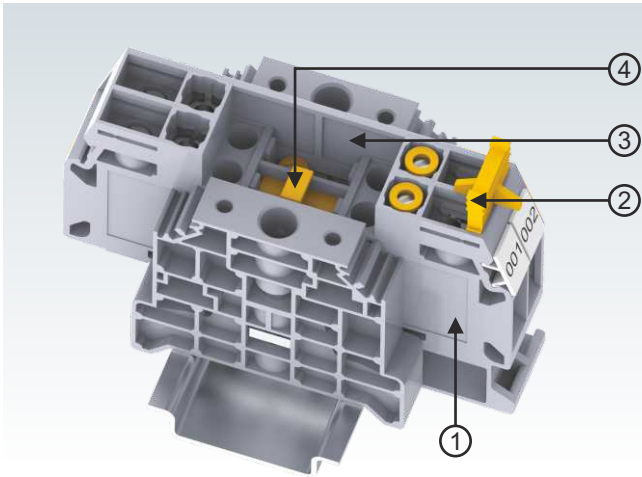

No.	Cat. No.	Qty.
1	CDS6U	2
2	SLS2	1
3	EPCDS6U	1
4	LCCDS	1

Operating status

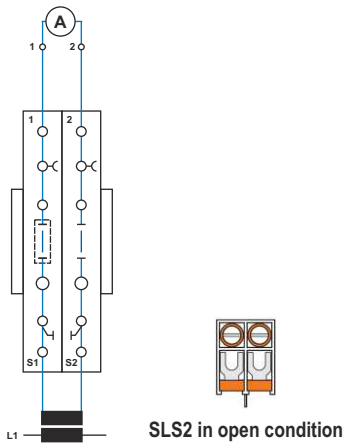

Meter test for L1 through external power supply

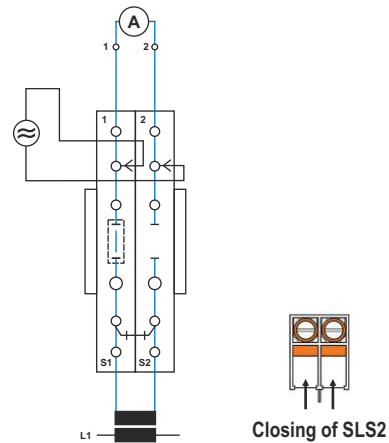

Sequence for test :

- 1) Close short circuit slide SLS2 of terminals 1 and 2.
- 2) Open disconnect slide link of terminal 2.
- 3) Connect external power supply to test sockets of terminals 1 and 2.

Comparison measurement for L1

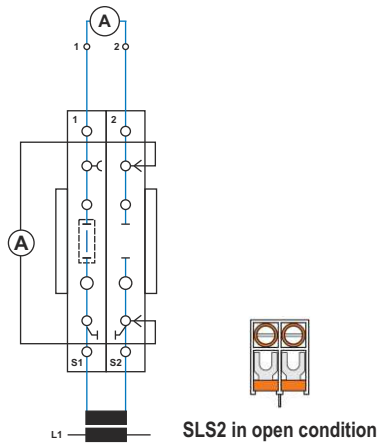

Sequence for test :

- 1) Remove SLS2 screw from terminal 2.
- 2) Connect ammeter to test sockets of terminal 2.
- 3) Open disconnect slide link of terminal 2.

Changing the meter for L1

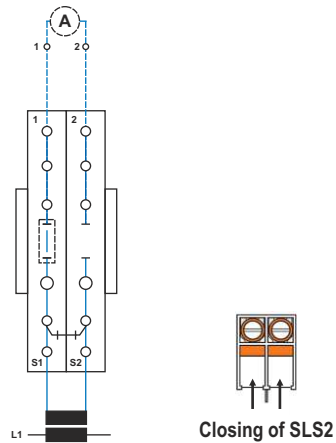

Sequence for test :

- 1) Close short circuit slide SLS2 of terminals 1 and 2.
- 2) Open disconnect slide link of terminal 2.
- 3) Disconnect meter for L1 at terminals 1 and 2.

Usage of CDS6U range of products in 3 Phase Current Transformer Test Set

Usage of CDS6U range of products in 3 Phase Linked Current Transformer Test Set

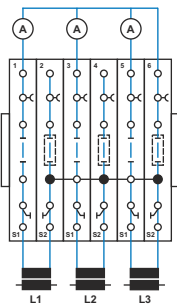
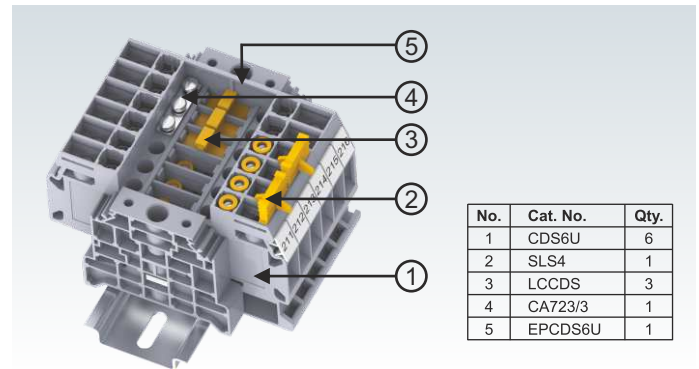
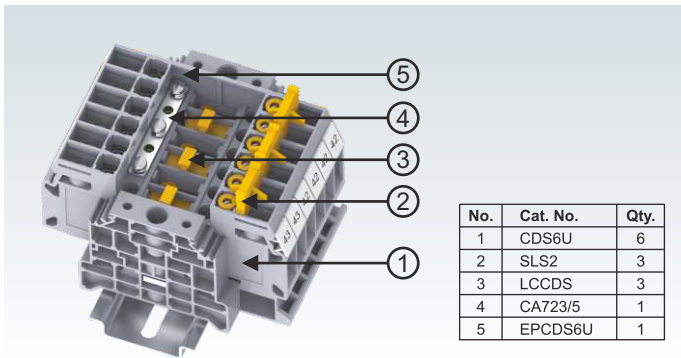

Operating status
(with internal distribution of the k-point)



SLS2 in open condition

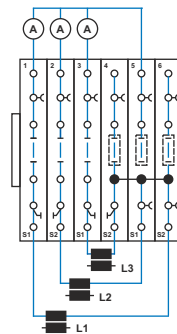

Operating status

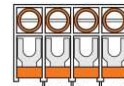

SLS4 in open condition

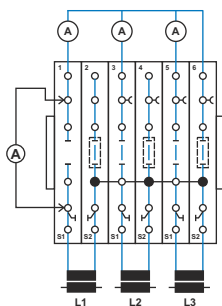

Comparison measurement for L1

Sequence for test :

- 1) Remove SLS2 screw from terminal 1.
- 2) Connect ammeter to test sockets of terminal 1.
- 3) Open disconnect slide link of terminal 1.

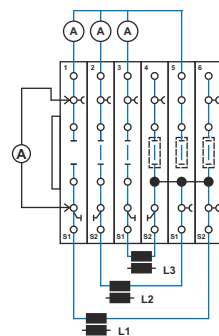

Comparison measurement for L1

Sequence for test :

- 1) Remove SLS4 screw from terminal 1.
- 2) Connect ammeter to test sockets of terminal 1.
- 3) Open disconnect slide link of terminal 1.

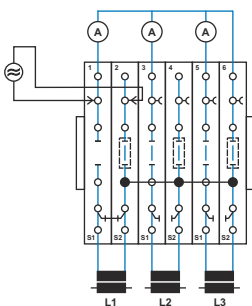

Meter test for L1 through external power supply

Sequence for test :

- 1) Close short circuit slide SLS2 of terminals 1 and 2.
- 2) Open disconnect slide link of terminal 1.
- 3) Connect external power supply to test sockets of terminals 1 and 2.

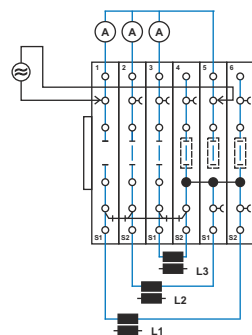

Meter test for L1 through external power supply

Sequence for test :

- 1) Close short circuit slide SLS4 of terminals 1,2, 3 and 4.
- 2) Open disconnect slide link of terminal 1.
- 3) Connect external power supply to test sockets of terminals 1 and 5.

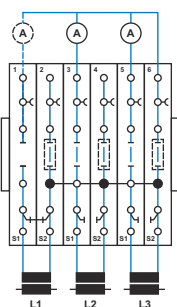

Changing the meter for L1

Sequence for test :

- 1) Close short circuit slide SLS2 of terminals 1 and 2.
- 2) Open disconnect slide link of terminal 1.
- 3) Disconnect meter for L1.

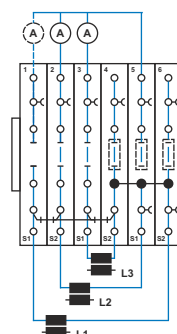

Changing the meter for L1

Sequence for test :

- 1) Close short circuit slide SLS4 of terminals 1,2, 3 and 4.
- 2) Open disconnect slide link of terminal 1.
- 3) Disconnect meter for L1.

Usage of CDS6U Test Disconnect Terminal Block for 3 Phase 4 wire multi function meter

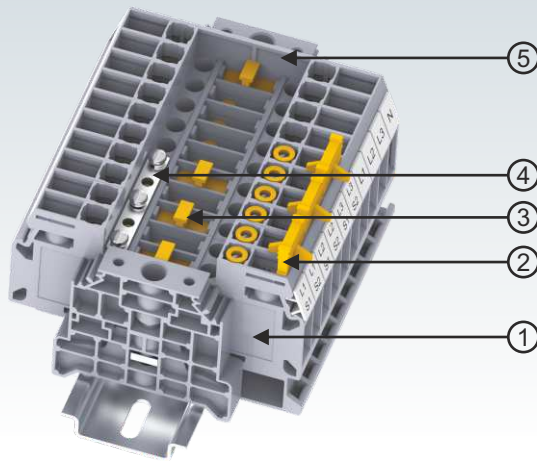

No.	Cat. No.	Qty.
1	CDS6U	10
2	SLS2	3
3	LCCDS	4
4	CA723/5	1
5	EPCDS6U	1

Operating status

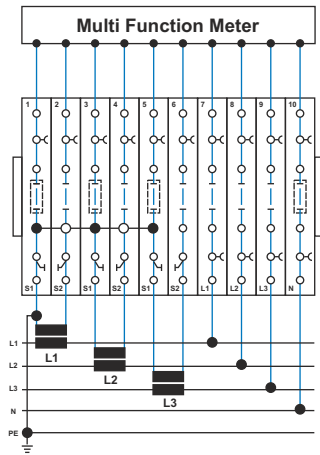

SLS2 in open condition

Meter test for L1 through external power supply

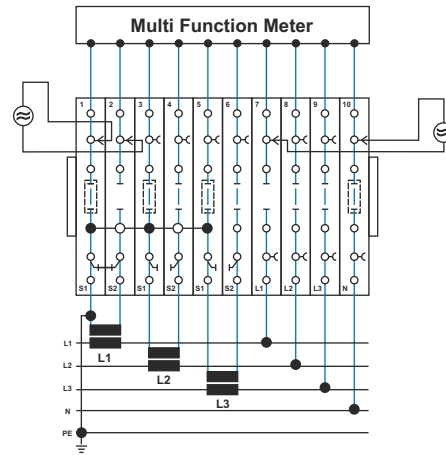

Closing of SLS2

Sequence for test :

- 1) Close short circuit slide SLS2 of terminals 1 and 2.
- 2) Open disconnect slide link of terminal 2 and 7.
- 3) Connect external power supply to test sockets of terminals 1, 2 and 7, 10.

Comparison measurement for L1

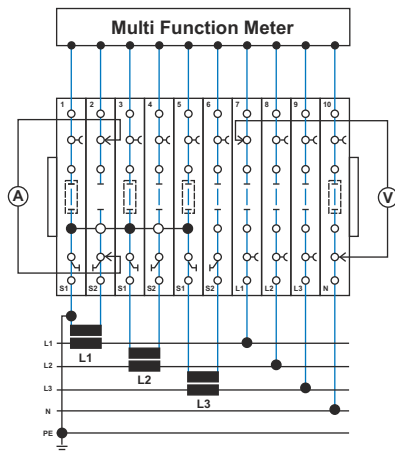

SLS2 in open condition

Sequence for test :

- 1) Remove SLS2 screw from terminal 2.
- 2) Connect ammeter to test sockets of terminal 2.
- 3) Open disconnect slide link of terminal 2.
- 4) Connect voltmeter to test sockets of terminals 7 and 10.

Changing the meter for L1

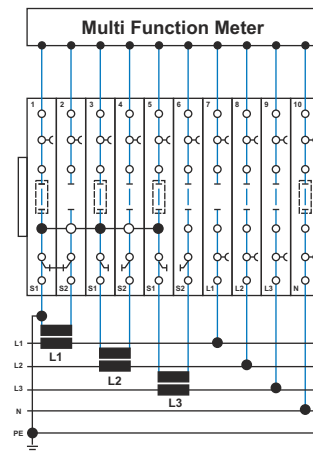

Closing of SLS2

Sequence for test :

- 1) Close short circuit slide SLS2 of terminals 1 and 2.
- 2) Open disconnect slide link of terminal 2 and 7.
- 3) Disconnect meter for L1 at terminals 1, 2 and 7.

DISCONNECT & TEST TERMINAL BLOCKS

CSDL4U



DDDL4U

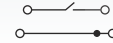
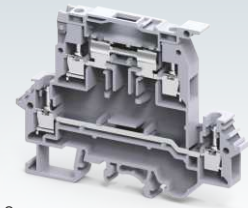

Width (Thickness) x Length	8 x 58 mm			
Height with DIN 35 x 7.5 / 35 x 15 / 32 mm Rail	44.5 mm / 52.0 mm / 49.4 mm			
Connection Possibility as per	IEC	UL - CSA		
	With 1 Conductor per clamp	Stranded / Flexible	0.2 - 4.0 mm ²	22 - 10 AWG
	Solid	0.2 - 6.0 mm ²		
With 2 same size Conductors per clamp	Stranded / Flexible with TWIN Ferrule / Lug	0.2 - 4.0 mm ²	22 - 10 AWG	
Wire Stripping Length	9.5 mm			
Ratings As Per	IEC60947-7-1	UL-1059	CSA22.2-158	
Voltage	1000 V	600 V	600 V	
	Current	10 A	14 A	14 A
Torque	0.5 Nm	7 lb-in	7 lb-in	
	Approvals			
Insulation Material / Material Group	Polyamide 6,6 / 1			
Rated Impulse Voltage / Pollution Degree	5 KV / 3			

Width (Thickness) x Length	8 x 88 mm			
Height with DIN 35 x 7.5 / 35 x 15 / 32 mm Rail	67.4 mm / 74.3 mm / 71.4 mm			
Connection Possibility as per	IEC	UL - CSA		
	With 1 Conductor per clamp	Stranded / Flexible	0.2 - 4.0 mm ²	22 - 10 AWG
	Solid	0.2 - 6.0 mm ²		
With 2 same size Conductors per clamp	Stranded / Flexible with TWIN Ferrule / Lug	0.2 - 4.0 mm ²	22 - 10 AWG	
Wire Stripping Length	9.5 mm			
Ratings As Per	IEC60947-7-1	UL-1059	CSA22.2-158	
Voltage	800 V	600 V	600 V	
	Current	10 A	6.3 A	14 A
Torque	0.5 Nm	7 lb-in	7 lb-in	
	Approvals			
Insulation Material / Material Group	Polyamide 6,6 / 1			
Rated Impulse Voltage / Pollution Degree	5 KV / 3			

	Type / Cat. No.	Standard Pack
Terminal Block	Grey	CSDL4U
	Blue	
	Black	
End Plate	EPCSFL4U	50
Mounting Rail (Refer Pg. 263 for details)	CA701-1M / CA701-1M-S	50 m
	CA701-15-1M / CA701-15-1M-S	25 m
End Clamp (Refer Pg. 264 for details)	CA702 / CA802	50
Marking Tags (On Terminal Continuous Tag)	CA509/K8WHT	100
	CA509/K2WHT	100
Marker Card (Refer Pg. 269 for details)	MC8	10
	MC2	10
Screw Driver	SCS0.6/3.5 Blade size: 0.6 x 3.5 mm	10

	Type / Cat. No.	Standard Pack
Terminal Block	DDDL4U	20
	DDDL4UBU	20
	DDDL4UBK	20
End Plate	EPDDFL4U	50
Mounting Rail (Refer Pg. 263 for details)	CA701-1M / CA701-1M-S	50 m
	CA701-15-1M / CA701-15-1M-S	25 m
End Clamp (Refer Pg. 264 for details)	CA702 / CA802	50
Marking Tags (On Terminal Continuous Tag)	CA509/K8WHT	100
	CA509/K2WHT	100
Marker Card (Refer Pg. 269 for details)	MC8	10
	MC2	10
Screw Driver	SCS0.6/3.5 Blade size: 0.6 x 3.5 mm	10

Jumpers	Screw Type Jumpers	Configurable Jumper Bar	Short Sleeve & Screw for configurable jumper bar	External Jumpers	Uninsulated	Insulated	Imax	Standard Pack
					2 pole			
	3 pole							
	4 pole							
	10 pole							
	100 pole							
	2 pole							
	3 pole							
	4 pole							
	10 pole							
	2 pole							
	3 pole							
	4 pole							
	10 pole							

Jumpers	Screw Type Jumpers	Configurable Jumper Bar	Short Sleeve & Screw for configurable jumper bar	External Jumpers	Uninsulated	Insulated	Imax	Standard Pack
					CA729/2	CA749/2	32 A	100
	CA729/3	CA749/3	32 A	50				
	CA729/4	CA749/4	32 A	50				
	CA729/10	CA749/10	32 A	10				
	CA703/6		32 A	100				
	CA704/6		32 A	100				
	CA705/6		32 A	100				
	CA737/10		32 A	100				
	CA707/S/Q/3			100				
	CA711/2		32 A	100				
	CA711/3		32 A	50				
	CA711/4		32 A	50				
	CA711/10		32 A	20				

DISTRIBUTION BLOCKS

The CDB range of Distribution Blocks is an ideal choice for a simplified distribution system. A bolt in the center of the block provides a connection point for the incoming cable. All the terminals are internally connected and provide multiple connection points for the outgoing wires. A protective shield effectively shrouds the incoming connection.

CDB4(1) blocks are recommended for applications where the input connection point is located at one end instead of the center.

CMDB blocks are a modified version of the CDB Terminal Blocks without the central incoming terminal connection.

Note:
Sum of outgoing currents on either side of the center should not exceed half the maximum permissible incoming current

Sum of total outgoing currents should not exceed maximum permissible incoming current.

Connection for higher outgoing currents should be done through the terminal nearest to the incoming connection.

Height with DIN 35 x 7.5 / 35 x 15 / 32 mm Rail	46.2 mm / 53.7 mm / 51.1 mm		
Wire size at Input	16.0 mm ² / 8 AWG		
Connection Possibility as per	IEC	UL - CSA	
With 1 Conductor per clamp	Stranded / Flexible	0.2 - 4.0 mm ² / 22 - 10 AWG	
	Solid with Ferrule / Lug	0.2 - 6.0 mm ² / 22 - 10 AWG	
With 2 same size Conductors per clamp	Stranded / Flexible	0.2 - 4.0 mm ² / 22 - 10 AWG	
	with TWIN Ferrule / Lug	0.2 - 2.5 mm ² / 22 - 12 AWG	
Wire Stripping Length	8 mm		
Ratings As Per	IEC60947-7-1	UL-1059	CSA22.2-158
Voltage	800 V	600 V	600 V
Current	Total Output (on either side of Input)	Input	50 A
		Output	25 A
Torque	Input	64 A	50 A
		32 A	35 A
Torque	Output	26 lb-in	26 lb-in
		7 lb-in	7 lb-in
Approvals			
Insulation Material / Material Group	Polyamide 6,6 / 1		
Rated Impulse Voltage / Pollution Degree	8 KV / 3		

CDB4

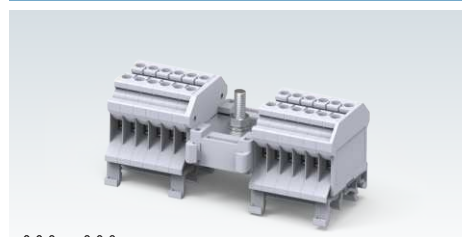

Terminal Block	Type / Cat. No.	No. of Outputs	Standard Pack
CDB4/1		4	10
CDB4/2		8	10
CDB4/3		12	10
CDB4/4		16	10
CDB4/5		20	5
CDB4/6		24	5

Mounting Rail (Refer Pg. 263 for details)		CA701-1M / CA701-1M-S	50 m
End Clamp (Refer Pg. 264 for details)		CA701-15-1M / CA701-15-1M-S	25 m
Marking Tags (Refer Pg. 268 for details)		CA702 / CA802	50
Marker Card (Refer Pg. 269 for details)		CA509/K6WHT	100
Screw Driver		MC6	10
		SCS0.6/3.5 Blade size: 0.6 x 3.5 mm	10

Type / Cat. No.	H x W x T (mm)	No. of Output
CDB4/1	45 x 43 x 44	4
CDB4/2	45 x 43 x 56	8
CDB4/3	45 x 43 x 68	12
CDB4/4	45 x 43 x 80	16
CDB4/5	45 x 43 x 96	20
CDB4/6	45 x 43 x 108	24

Note: These Terminal Blocks are available in Red, Yellow, Blue, Black & Green colours.

CDB4(1)

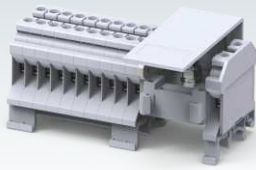

46.2 mm / 53.7 mm / 51.1 mm

16.0 mm² / 8 AWG

IEC	UL - CSA
0.2 - 4.0 mm ²	22 - 10 AWG
0.2 - 6.0 mm ²	
0.2 - 4.0 mm ²	22 - 10 AWG
0.2 - 2.5 mm ²	22 - 12 AWG
0.2 - 2.5 mm ²	22 - 12 AWG

8 mm

IEC60947-7-1 UL-1059 CSA22.2-158

800 V	600 V	600 V
64 A	50 A	50 A
64 A*	50 A	25 A
2.0 Nm	26 lb-in	26 lb-in
0.5 Nm	7 lb-in	7 lb-in



Polyamide 6,6 / 1

8 KV / 3

Type / Cat. No.	No. of Outputs	Standard Pack
CDB4/2(1)	6	10
CDB4/3(1)	8	10
CDB4/4(1)	10	10
CDB4/5(1)	12	5
CDB4/6(1)	14	5
CDB4/10(1)	22	5
CDB4/11(1)	24	5
CA701-1M / CA701-1M-S		50 m
CA701-15-1M / CA701-15-1M-S		25 m
CA702 / CA802		50
CA509/K6WHT		100
MC6		10
SCS0.6/3.5 Blade size: 0.6 x 3.5 mm		10

Type / Cat. No.	H x W x T (mm)	No. of Output
CDB4/2(1)	45 x 43 x 52	6
CDB4/3(1)	45 x 43 x 58	8
CDB4/4(1)	45 x 43 x 64	10
CDB4/5(1)	45 x 43 x 70	12
CDB4/6(1)	45 x 43 x 76	14
CDB4/10(1)	45 x 43 x 100	22
CDB4/11(1)	45 x 43 x 106	24

* Total output current of the system.

CDB6

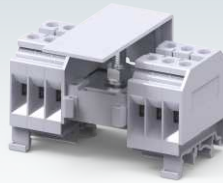

47.8 mm / 55.5 mm / 52.8 mm

25.0 mm² / 2 AWG

IEC	UL - CSA
1.5 - 6.0 mm ²	22 - 8 AWG
1.5 - 6.0 mm ²	
1.5 - 6.0 mm ²	22 - 8 AWG
1.5 - 4.0 mm ²	22 - 10 AWG
1.5 - 4.0 mm ²	22 - 10 AWG

9 mm

IEC60947-7-1 UL-1059 CSA22.2-158

800 V	600 V	600 V
82 A	100 A	100 A
41 A	50 A	50 A
3.0 Nm	35 lb-in	35 lb-in
0.8 Nm	14 lb-in	14 lb-in



Polyamide 6,6 / 1

8 KV / 3

Type / Cat. No.	No. of Outputs	Standard Pack
CDB6/1	4	10
CDB6/2	8	10
CDB6/3	12	10
CDB6/4	16	5
CA701-1M / CA701-1M-S		50 m
CA701-15-1M / CA701-15-1M-S		25 m
CA702 / CA802		50
CA509/K8WHT		100
MC8		10
SCS0.8/4 Blade size: 0.8 x 4 mm		10

Type / Cat. No.	H x W x T (mm)	No. of Output
CDB6/1	43 x 48 x 48	4
CDB6/2	43 x 48 x 64	8
CDB6/3	43 x 48 x 80	12
CDB6/4	43 x 48 x 96	16

CDB10

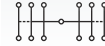
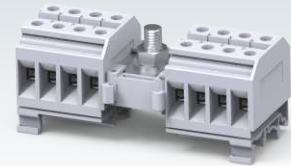

47.8 mm / 55.5 mm / 52.8 mm

35.0 mm² / 1/0 AWG

IEC	UL - CSA
1.5 - 10 mm ²	16 - 6 AWG
1.5 - 10 mm ²	
1.5 - 10 mm ²	16 - 6 AWG
1.5 - 6 mm ²	16 - 8 AWG
1.5 - 6 mm ²	16 - 8 AWG

11 mm

IEC60947-7-1 UL-1059 CSA22.2-158

800 V	600 V	600 V
114 A	130 A	130 A
57 A	65 A	65 A
6.0 Nm	53 lb-in	53 lb-in
1.2 Nm	14 lb-in	14 lb-in



Polyamide 6,6 / 1

8 KV / 3

Type / Cat. No.	No. of Outputs	Standard Pack
CDB10/2	8	10
CDB10/3	12	10
CDB10/4	16	5
CA701-1M / CA701-1M-S		50 m
CA701-15-1M / CA701-15-1M-S		25 m
CA702 / CA802		50
CA509/K10WHT		100
MC10		10
SCS0.8/4 Blade size: 0.8 x 4 mm		10

Type / Cat. No.	H x W x T (mm)	No. of Output
CDB10/2	43 x 48 x 72	8
CDB10/3	43 x 48 x 92	12
CDB10/4	43 x 48 x 112	16

Phase Distribution Application with CDB Terminals

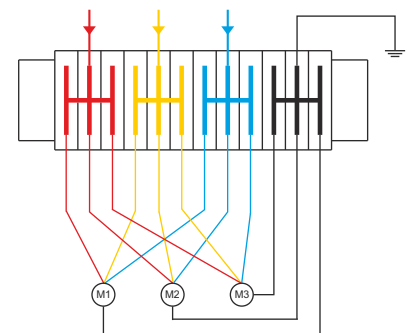

DISTRIBUTION BLOCKS

CDB25

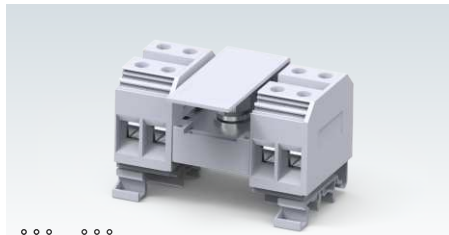

CMDB4

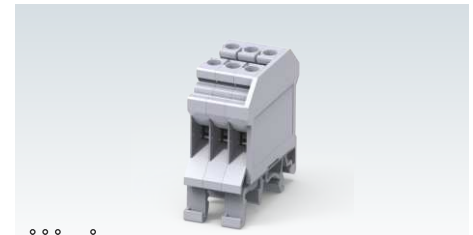

Height with DIN 35 x 7.5 / 35 x 15 / 32 mm Rail	57.2 mm / 64.7 mm / 62.3 mm				46.2 mm / 53.7 mm / 51.1 mm			
Wire size at Input	50.0 mm ² / 2/0 AWG							
Connection Possibility as per	IEC		UL - CSA		IEC		UL - CSA	
With 1 Conductor per clamp	Stranded / Flexible	6.0 - 25 mm ²		12 - 2 AWG		0.2 - 4.0 mm ²	22 - 10 AWG	
	Solid with Ferrule / Lug	6.0 - 25 mm ²		12 - 2 AWG		0.2 - 6.0 mm ²	22 - 10 AWG	
With 2 same size Conductors per clamp	Stranded / Flexible	6.0 - 16 mm ²		12 - 8 AWG		0.2 - 2.5 mm ²	22 - 12 AWG	
	with TWIN Ferrule / Lug	6.0 - 16 mm ²		12 - 8 AWG		0.2 - 2.5 mm ²	22 - 12 AWG	
Wire Stripping Length	14 mm				8 mm			
Ratings As Per	IEC60947-7-1		UL-1059		IEC60947-7-1		UL-1059	
Voltage	800 V	600 V	600 V		1000 V	600 V		
Current	Total Output (on either side of Input)	Input	150 A	150 A	150 A	32 A	35 A	
		Output	75 A	75 A	150 A			
Torque	Input Output	6.0 Nm	53 lb-in			0.5 Nm	7 lb-in	
		2.0 Nm	22 lb-in					
Approvals								
Insulation Material / Material Group	Polyamide 6,6 / 1				Polyamide 6,6 / 1			
Rated Impulse Voltage / Pollution Degree	8 KV / 3				8 KV / 3			
	Type / Cat. No.	No. of Outputs	Standard Pack		Type / Cat. No.	No. of Outputs	Standard Pack	
Terminal Block	CDB25/1	4	10		CMDB4/2	4	10	
	CDB25/2	8	10		CMDB4/3	6	10	
	CDB25/3	12	10		CMDB4/4	8	10	
	CDB25/4	16	5		CMDB4/10	20	5	
Mounting Rail (Refer Pg. 263 for details)	CA701-1M / CA701-1M-S	50 m			CA701-1M / CA701-1M-S	50 m		
	CA701-15-1M / CA701-15-1M-S	25 m			CA701-15-1M / CA701-15-1M-S	25 m		
End Clamp (Refer Pg. 264 for details)	CA702 / CA802		50		CA702 / CA802		50	
Marking Tags (Refer Pg. 268 for details)	CA509/K12WHT		100		CA509/K6WHT		100	
Marker Card (Refer Pg. 269 for details)	MC12		10		MC6		10	
Warning Label					SWL4		50	
Screw Driver	SCS1.0/5.5	Blade size: 1.0 x 5.5 mm	10		SCS0.6/3.5	Blade size: 0.6 x 3.5 mm	10	
	Type / Cat. No.	H x W x T (mm)	No. of Output		Type / Cat. No.	H x W x T (mm)	No. of Output	
	CDB25/1	56 x 49 x 64	4		CMDB4/2	45 x 43 x 13.5	4	
	CDB25/2	56 x 49 x 88	8		CMDB4/3	45 x 43 x 19.5	6	
	CDB25/3	56 x 49 x 112	12		CMDB4/4	45 x 43 x 25.5	8	
	CDB25/4	56 x 49 x 136	16		CMDB4/10	45 x 43 x 61.5	20	

Note: These Terminal Blocks are available in Red, Yellow, Blue, Black & Green colours.

CMDB6



47.8 mm / 55.5 mm / 52.8 mm

IEC	UL - CSA
1.5 - 6.0 mm ²	22 - 8 AWG
1.5 - 6.0 mm ²	22 - 8 AWG
1.5 - 4.0 mm ²	22 - 10 AWG
1.5 - 4.0 mm ²	22 - 10 AWG

9 mm

IEC60947-7-1 UL-1059

1000 V	600 V		
41 A	50 A		

0.8 Nm 14 lb-in



Polyamide 6,6 / 1

8 KV / 3

Type / Cat. No.	No. of Outputs	Standard Pack
CMDB6/2	4	10
CMDB6/3	6	10
CMDB6/4	8	5
CMDB6/10	20	5
CA701-1M / CA701-1M-S		50 m
CA701-15-1M / CA701-15-1M-S		25 m
CA702 / CA802		50
CA509/K8WHT		100
MC8		10
SWL6		50
SCS0.8/4	Blade size: 0.8 x 4 mm	10

Type / Cat. No.	H x W x T (mm)	No. of Output
CMDB6/2	43 x 48 x 17.5	4
CMDB6/3	43 x 48 x 25.5	6
CMDB6/4	43 x 48 x 33.5	8
CMDB6/10	43 x 48 x 81.5	20

CMDB10



47.8 mm / 55.5 mm / 52.8 mm

IEC	UL - CSA
1.5 - 10.0 mm ²	22 - 6 AWG
1.5 - 10.0 mm ²	22 - 6 AWG
1.5 - 6.0 mm ²	22 - 10 AWG
1.5 - 6.0 mm ²	22 - 10 AWG

11 mm

IEC60947-7-1 UL-1059

1000 V	600 V		
57 A	65 A		

1.2 Nm 14 lb-in



Polyamide 6,6 / 1

8 KV / 3

Type / Cat. No.	No. of Outputs	Standard Pack
CMDB10/2	4	10
CMDB10/3	6	10
CMDB10/4	8	5
CMDB10/10	20	5
CA701-1M / CA701-1M-S		50 m
CA701-15-1M / CA701-15-1M-S		25 m
CA702 / CA802		50
CA509/K10WHT		100
MC10		10
SCS0.8/4	Blade size: 0.8 x 4 mm	10

Type / Cat. No.	H x W x T (mm)	No. of Output
CMDB10/2	43 x 48 x 21.5	4
CMDB10/3	43 x 48 x 31.5	6
CMDB10/4	43 x 48 x 41.5	8
CMDB10/10	43 x 48 x 101.5	20

CMDB25



57.2 mm / 64.7 mm / 62.3 mm

IEC	UL - CSA
6.0 - 25.0 mm ²	12 - 4 AWG
6.0 - 25.0 mm ²	12 - 4 AWG
6.0 - 16.0 mm ²	12 - 6 AWG
6.0 - 16.0 mm ²	12 - 8 AWG

14 mm

IEC60947-7-1 UL-1059 CSA22.2-158

800 V	600 V	600 V	
101 A	85 A	85 A	

2.0 Nm 22 lb-in 22 lb-in



Polyamide 6,6 / 1

8 KV / 3

Type / Cat. No.	No. of Outputs	Standard Pack
CMDB25/2	4	10
CMDB25/3	6	10
CMDB25/4	8	5
CMDB25/10	20	5
CA701-1M / CA701-1M-S		50 m
CA701-15-1M / CA701-15-1M-S		25 m
CA702 / CA802		50
CA509/K12WHT		100
MC12		10
SCS1.0/5.5	Blade size: 1.0 x 5.5 mm	10

Type / Cat. No.	H x W x T (mm)	No. of Output
CMDB25/2	56 x 49 x 26	4
CMDB25/3	56 x 49 x 38	6
CMDB25/4	56 x 49 x 50	8
CMDB25/10	56 x 49 x 62	20

DISTRIBUTION BLOCKS

CMDB12



Height with DIN 35 x 7.5 / 35 x 15 / 32 mm Rail	47.4 mm / 54.9 mm		
Wire size at Input	10 mm ² / 6 AWG		
Connection Possibility as per	IEC	UL - CSA	
With 1 Conductor per clamp	Stranded / Flexible	0.2 - 4.0 mm ²	22 - 10 AWG
	Solid	0.2 - 6.0 mm ²	
With 2 same size Conductors per clamp	with Ferrule / Lug	0.2 - 4.0 mm ²	22 - 10 AWG
	Stranded / Flexible	0.2 - 2.5 mm ²	22 - 12 AWG
Wire Stripping Length	with TWIN Ferrule / Lug	0.2 - 2.5 mm ²	22 - 12 AWG
		11 mm / 8 mm	
Ratings As Per	IEC60947-7-1	UL-1059	
Voltage	1000 V	600 V	
Current	Input	57 A	65 A
	Total Output (on either side of Input)	32 A	35 A
Torque	Input	1.2 Nm	14 lb-in
	Output	0.5 Nm	7 lb-in
Approvals	CE		
Insulation Material / Material Group	Polyamide 6,6 / 1		
Rated Impulse Voltage / Pollution Degree	8 KV / 3		
	Type / Cat. No.	No. of Outputs	Standard Pack
Terminal Block	CMDB12	20	10
Mounting Rail (Refer Pg. 263 for details)	CA701-1M / CA701-1M-S		50 m
	CA701-15-1M / CA701-15-1M-S		25 m
End Clamp (Refer Pg. 264 for details)	CA702 / CA802		50
Marking Tags (Refer Pg. 268 for details)	CA509/K10WHT / CA509/K6WHT		100
Screw Driver	SCS0.8/4	Blade size: 0.8 x 4 mm	10
Screw Driver	SCS0.6/3.5	Blade size: 0.6 x 3.5 mm	10

Note: These Terminal Blocks are available in Red, Yellow, Blue, Black & Green colours.

COMPACT DISTRIBUTION BLOCKS

Compact Distribution Block is used for single phase distribution systems. These blocks can either be mounted on a Din Rail or can be panel mounted.

These blocks are completely shrouded and offer IP 20 protection.

DB16



Width (Thickness) x Length	27 x 66 mm
Height with DIN 35 x 7.5 / 35 x 15 mm Rail	50.8 mm / 57.8 mm
Total number of connection points	7

Connection Possibility as per		IEC	UL - CSA
At 1 Connection Point (Input)	Wire Range	6 - 16 mm ² (3 Conn.)	8 - 4 AWG
	Stripping Length		
	Torque		
At Position A in diagram below	Wire Range	15 mm	15 mm
	Stripping Length		
	Torque		
At Position B in diagram below	Wire Range	2.5 - 6 mm ² (4 Conn.)	14 - 10 AWG
	Stripping Length		
	Torque		
At Position C in diagram below	Wire Range	9 mm	9 mm
	Stripping Length		
	Torque		

Ratings As Per	IEC60947-7-1	UL-1059	CSA22.2-158
Voltage	1000 V	600 V	600 V
Current	76 A	80 A	80 A

Approvals	
Insulation Material / Material Group	Polyamide 6,6 / 1
Rated Impulse Voltage / Pollution Degree	6 KV / 3

Type / Cat. No.	Standard Pack	
Terminal Block		
Grey	DB16	10
Blue	DB16BU	10
Red	DB16R	10
Yellow	DB16Y	10
Black	DB16BK	10
Green	DB16GN	10

Mounting Rail (Refer Pg. 263 for details)		CA701-1M / CA701-1M-S	50 m
		CA701-15-1M / CA701-15-1M-S	25 m

End Clamp (Refer Pg. 264 for details)		CA702 / CA802	50
---------------------------------------	--	---------------	----

Marking Tags (Refer Pg. 268 for details)		CA509/K7.5WHT	100
--	--	---------------	-----

Screw Driver		SCPH2	Blade size: 2 x 100 mm	10
--------------	--	-------	------------------------	----

Note:
Sum of total outgoing currents should not exceed maximum permissible incoming current.

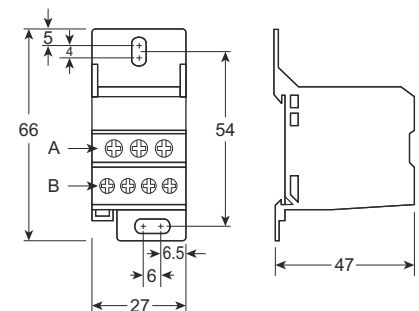

DB35



PDB70



Width (Thickness) x Length	27 x 74.5 mm	29 x 77 mm
Height with DIN 35 x 7.5 / 35 x 15 mm Rail	50.8 mm / 57.8 mm	46.8 mm / 47.2 mm
Total number of connection points	8	7

Connection Possibility as per	IEC		UL - CSA	
	At 1 Connection Point (Input)	Wire Range	10 - 70 mm ² (1 Conn.)	8 - 3/0 AWG
	Stripping Length	22 mm	22 mm	
	Torque	8.5 Nm	75 lb-in	
At Position A in diagram below	Wire Range	6 - 35 mm ² (1 Conn.)	8 - 2 AWG	
	Stripping Length	15 mm	15 mm	
	Torque	6 Nm	40 lb-in	
At Position B in diagram below	Wire Range	6 - 16 mm ² (1 Conn.)	8 - 4 AWG	
	Stripping Length	15 mm	15 mm	
	Torque	3 Nm	14 lb-in	
At Position C in diagram below	Wire Range	2.5 - 10 mm ² (6 Conn.)	14 - 6 AWG	2.5 - 16 / 6 - 16 mm ² (6 Conn.)
	Stripping Length	10 mm	10 mm	12 mm
	Torque	2.0 Nm	17.5 lb-in	3.5 Nm

Ratings As Per	IEC60947-7-1	UL-1059			IEC60947-7-1			
Voltage	1000 V	600 V			690 V			
Current	125 A	115 A			160 A			
Approvals								
Insulation Material / Material Group	Polyamide 6,6 / 1				Polyamide 6,6 / 1			
Rated Impulse Voltage / Pollution Degree	6 KV / 3				6 KV / 3			

Terminal Block		Type / Cat. No.	Standard Pack
	Grey	DB35	10
	Blue	DB35BU	10
	Red	DB35R	10
	Yellow	DB35Y	10
	Black	DB35BK	10
	Green	DB35GN	10
Mounting Rail (Refer Pg. 263 for details)		CA701-1M / CA701-1M-S	50 m
		CA701-15-1M / CA701-15-1M-S	25 m
End Clamp (Refer Pg. 264 for details)		CA702 / CA802	50
Marking Tags (Refer Pg. 268 for details)		CA509/K7.5WHT	100
Screw Driver		SCPH2 Blade size: 2 x 100 mm	10

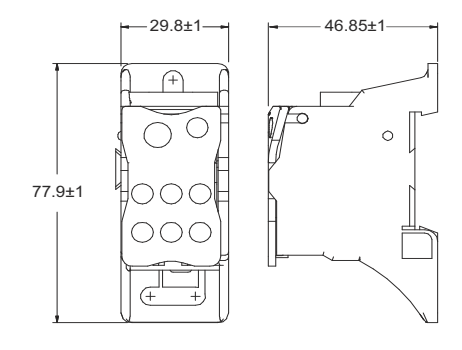
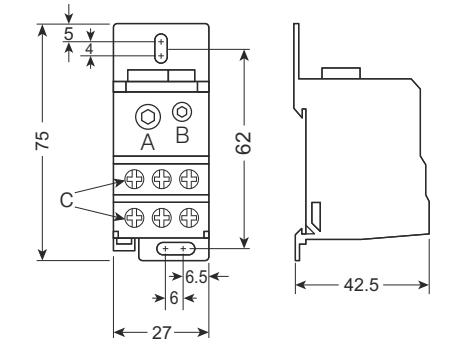

PDB120



49 x 96 mm

50.8 mm / 51.2 mm

11

IEC	UL - CSA
35 - 120 mm ² (1 Conn.)	6 - 250 KCMIL
24 mm	24 mm
19.0 Nm	221 lb-in

6-35 / 2.5-16 / 2.5-10 mm ² (11 Conn.)	14-1 / 14-4 / 14-6 AWG (11 Conn.)
15 / 12 / 11 mm	15 / 12 / 11 mm
4.4 / 2.7 / 2.7 Nm	39 / 24 / 24 lb-in

IEC60947-7-1

690 V

250 A



Polyamide 6,6 / 1

6 KV / 3

Type / Cat. No.	Standard Pack
PDB120	1

CA701-1M / CA701-1M-S	50 m
CA701-15-1M / CA701-15-1M-S	25 m
CA702 / CA802	50

PDB185

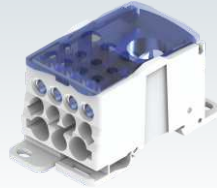

53.3 x 94 mm

68 mm / 74.0 mm

8

IEC	UL - CSA
95 - 185 mm ² (1 Conn.)	3/0 - 400 KCMIL
24 mm	24 mm
25.0 Nm	221 lb-in

6-35 / 2.5-16 / 2.5-10 mm ² (11 Conn.)	14-1 / 14-4 / 14-6 AWG (11 Conn.)
15 / 12 / 11 mm	15 / 12 / 11 mm
4.4 / 2.7 / 2.7 Nm	39 / 24 / 24 lb-in

IEC60947-7-1

UL-1059

690 V

400 A



Polyamide 6,6 / 1

6 KV / 3

Type / Cat. No.	Standard Pack
PDB185	1

CA701-1M / CA701-1M-S	50 m
CA701-15-1M / CA701-15-1M-S	25 m
CA702 / CA802	50

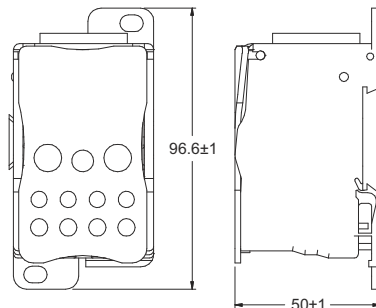
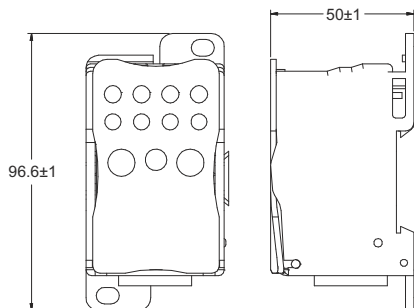

LIGHTING POLE DISTRIBUTION BLOCK

CLP35/2 is a lighting pole Distribution Terminal Block suitable for 35 sq.mm wires. These terminals are also suitable for XLPE aluminium cable which are generally used for street lighting application.

CLP35/2A is a lighting pole Distribution Terminal Block with Allen Head screw.

CLP35/2



Width (Thickness) x Length	53.3 x 94 mm
Height with DIN 35 x 7.5 / 35 x 15 mm Rail	68 mm / 74.0 mm
Total number of connection points	8





Connection Possibility as per		IEC	UL - CSA
At 1 Connection Point (Input)	Wire Range	4 - 35 mm ² (1 Conn.)	12 - 2 AWG
	Stripping Length	15 mm	15 mm
	Torque	2.5 Nm	25 lb-in
At 2 Connection Points (Output)	Wire Range	4 - 35 mm ² (1 Conn.)	12 - 2 AWG
	Stripping Length	15 mm	15 mm
	Torque	2.5 Nm	25 lb-in
At 3 Connection Point (Output)	Wire Range	0.2 - 10 mm ² (1 Conn.)	20 - 4 AWG
	Stripping Length	11 mm	11 mm
	Torque	1.2 Nm	14 lb-in

Ratings As Per		IEC60947-7-1	UL-1059
Voltage		1000 V	600 V
Current	Input	115 A	115 A
	Output	76 A	75 A

Approvals 

Insulation Material / Material Group Polyamide 6,6 / 1

Rated Impulse Voltage / Pollution Degree 8 KV / 3

		Type / Cat. No.	Standard Pack
Terminal Block		CLP35/2	20
Mounting Rail (Refer Pg. 263 for details)		CA701-1M / CA701-1M-S	50 m
		CA701-15-1M / CA701-15-1M-S	25 m
End Clamp (Refer Pg. 264 for details)		CA702 / CA802	50
Marking Tags (Refer Pg. 268 for details)		CA509/K16WHT	100
Marker Card (Refer Pg. 269 for details)		MC16	10
Screw Driver		SCS1.0/5.5 Blade size: 1.0 x 5.5 mm	10

CLP35/2A

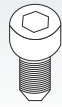

With Allen screw

53.3 x 94 mm

68 mm / 74.0 mm

8

IEC		UL - CSA	
4 - 35 mm ² (1 Conn.)	15 mm	12 - 2 AWG	15 mm
2.5 Nm		25 lb-in	
4 - 35 mm ² (1 Conn.)	15 mm	12 - 2 AWG	15 mm
2.5 Nm		25 lb-in	
0.2 - 10 mm ² (1 Conn.)	11 mm	20 - 4 AWG	11 mm
1.2 Nm		14 lb-in	
IEC60947-7-1	UL-1059		
1000 V	600 V		
115 A	115 A		
76 A	75 A		



Polyamide 6,6 / 1

8 KV / 3

Type / Cat. No.	Standard Pack
CLP35/2A	20
CA701-1M / CA701-1M-S	50 m
CA701-15-1M / CA701-15-1M-S	25 m
CA702 / CA802	50
CA509/K16WHT	100
MC16	10
SCS1.0/5.5 Blade size: 1.0 x 5.5 mm	10

COMPONENT CARRIER TERMINAL BLOCK

The CCC4U Terminal Block is a component carrier base. Various pluggable component carriers and disconnecting plugs can be installed easily. These component carriers have built in protection against incorrect polarity.

CCC4U

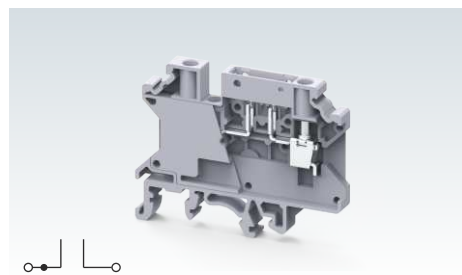

Width (Thickness) x Length	6 x 58.5 mm		
Height with DIN 35 x 7.5 / 35 x 15 / 32 mm Rail	46.0 mm / 53.5 mm / 51.5 mm		
Connection Possibility as per	IEC	UL - CSA	
With 1 Conductor per clamp	Stranded / Flexible	0.2 - 4.0 mm ²	24 - 10 AWG
	Solid	0.2 - 6.0 mm ²	
	with Ferrule / Lug	0.2 - 4.0 mm ²	24 - 10 AWG
With 2 same size Conductors per clamp	Stranded / Flexible	0.2 - 2.5 mm ²	24 - 12 AWG
	with TWIN Ferrule / Lug	0.2 - 2.5 mm ²	24 - 12 AWG
Wire Stripping Length	8 mm		
Ratings As Per	IEC60947-7-1 UL-1059		
Voltage	1000 V	600 V	
Current	*	*	
Torque	0.5 Nm	4.5 lb-in	
Approvals	CE		
Insulation Material / Material Group	Polyamide 6,6 / 1		
Rated Impulse Voltage / Pollution Degree	8 KV / 3		
	Type / Cat. No.	Standard Pack	
Terminal Block	CCC4U	50	
Mounting Rail (Refer Pg. 263 for details)	CA701-1M / CA701-1M-S	50 m	
	CA701-15-1M / CA701-15-1M-S	25 m	
End Clamp (Refer Pg. 264 for details)	CA702 / CA802	50	
Marking Tags (Refer Pg. 268 for details)	CA509/K6WHT	100	
Marker Card (Refer Pg. 269 for details)	MC6	10	
Screw Driver	SCS0.6/3.5	Blade size: 0.6 x 3.5 mm 10	
	Type / Cat. No.	Imax	Standard Pack
Jumpers	2 pole	CA722/2	10 A 100
	3 pole	CA722/3	10 A 100
	4 pole	CA722/4	10 A 100
	10 pole	CA722/10	10 A 10
Pre Assembled Jumpers			

* Current Rating is based on Plug used.

CPD1 is component plug with built in diode 1N4007. CPF is component fuse plug suitable for Ø 5 x 20 mm fuses. CPFL is component plug which provides offline indication in case of a blown off fuse. CIP is a disconnecting plug which can be installed in the base Terminal Block CCC4U.

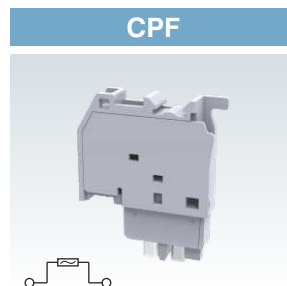
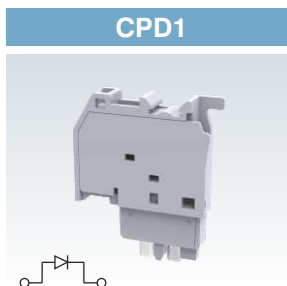

	Type / Cat. No.	Std. Pack	Type / Cat. No.	Std. Pack	Type / Cat. No.	Std. Pack
Component Carrier	CPD1	50	CPF	50	CIP	50
With Diode			CPFL6-60V	50		
For Ø 5 x 20 mm Fuse			CPFL110-240V	50		
Fuse with 6-60V AC/DC LED Circuit						
Fuse with 110-240V AC/DC LED Circuit						
Disconnection Plug						
Width (Thickness) x Length x Height	6 x 28 x 35 mm		6 x 28 x 35 mm		5.4 x 17.45 x 26 mm	
* Current Rating	1 A		6.3 A		10 A	
Marking Tags (Refer Pg. 268 for details)	CA509/K6WHT	100	CA509/K6WHT	100		

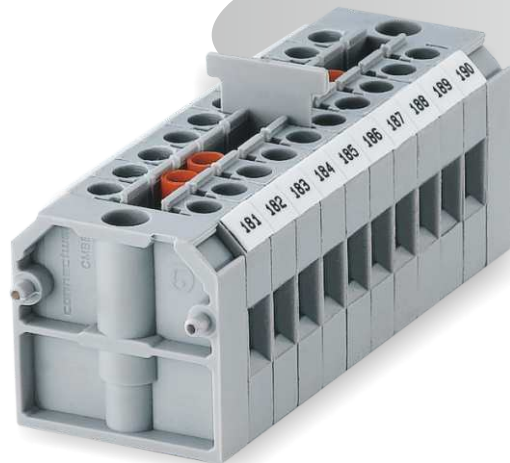
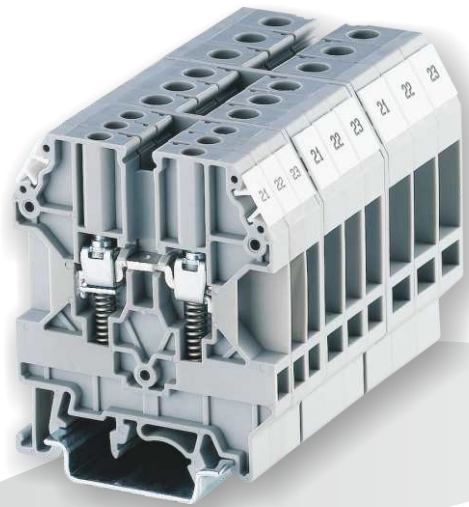
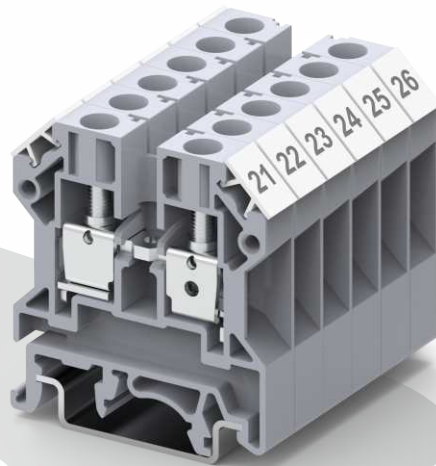

HIGH VOLTAGE TERMINAL BLOCKS

The CHV series Terminal Blocks have been specially designed for extremely high voltage (1500 VDC) applications.

A specially designed flexible foot enables easy mounting and dismounting from the mounting rail with the help of a screw driver. These Terminal Blocks have marker holding recesses to accept marking tags for circuit identification. Cross connection can be achieved with the aid of Jumpers / sleeves & screws.

CHV4U



Width (Thickness) x Length		6 x 52 mm			
Height with DIN 35 x 7.5 / 35 x 15 / 32 mm Rail		63.4 mm / 70.8 mm / 68.2 mm			
Connection Possibility as per		IEC		UL - CSA	
With 1 Conductor per clamp	Stranded / Flexible	0.2 - 4.0 mm ²	22 - 10 AWG		
	Solid with Ferrule / Lug	0.2 - 6.0 mm ²	22 - 10 AWG		
With 2 same size Conductors per clamp	Stranded / Flexible	0.2 - 4.0 mm ²	22 - 10 AWG		
	with TWIN Ferrule / Lug	0.2 - 2.5 mm ²	22 - 12 AWG		
Wire Stripping Length		12 mm			
Ratings As Per		IEC60947-7-1	UL-1059	CSA22.2-158	
Voltage		1000 V	1000 V	1000 V	
Current		32 A	35 A	35 A	
Torque		0.5 Nm	7 lb-in	7 lb-in	
Approvals					
Insulation Material / Material Group		Polyamide 6,6 / 1			
Rated Impulse Voltage / Pollution Degree		8 KV / 3			
		Type / Cat. No.		Standard Pack	
Terminal Block	Grey Blue	CHV4U	50		
		CHV4UBU	50		
End Plate		EPUSC	50		
Separator Plate		SP2.5/4UN	50		
Mounting Rail (Refer Pg. 263 for details)		CA701-1M / CA701-1M-S	50 m		
		CA701-15-1M / CA701-15-1M-S	25 m		
End Clamp (Refer Pg. 264 for details)		CA702 / CA802	50		
Marking Tags (Refer Pg. 268 for details)		CA509/K6WHT	100		
Marker Card (Refer Pg. 269 for details)		MC6	10		
Screw Driver		SCS0.6/3.5	Blade size: 0.6 x 3.5 mm	10	
Jumpers		Type / Cat. No.		Imax	Standard Pack
Screw Type Jumpers		2 pole	CA623/2	32 A	100
		3 pole	CA623/3	32 A	100
		4 pole	CA623/4	32 A	100
		10 pole	CA623/10	32 A	10

CHV6U

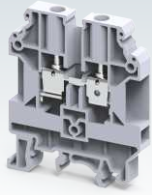

8 x 52 mm

63.4 mm / 70.8 mm / 68.2 mm

IEC	UL - CSA
0.2 - 6.0 mm ²	22 - 8 AWG
0.2 - 6.0 mm ²	22 - 8 AWG
0.2 - 4.0 mm ²	22 - 10 AWG
0.2 - 4.0 mm ²	22 - 10 AWG

14 mm

IEC60947-7-1 UL-1059 CSA22.2-158

1000 V	1000 V	1000 V
41 A	50 A	50 A
0.8 Nm	14 lb-in	14 lb-in



Polyamide 6,6 / 1

8 KV / 3

Type / Cat. No.	Standard Pack
CHV6U	50
CHV6UBU	50
EPUSC	50
SP2.5/4UN	50
CA701-1M / CA701-1M-S	50 m
CA701-15-1M / CA701-15-1M-S	25 m
CA702 / CA802	50
CA509/K8WHT	100
MC8	10
SCS0.8/4 Blade size: 0.8 x 4 mm	10

Type / Cat. No.	I _{max}	Standard Pack
CA624/2	41 A	100
CA624/3	41 A	100
CA624/4	41 A	100
CA624/10	41 A	10

CHV10U



10 x 52 mm

63.4 mm / 70.8 mm / 68.2 mm

IEC	UL - CSA
0.2 - 10.0 mm ²	20 - 6 AWG
0.2 - 10.0 mm ²	20 - 6 AWG
0.2 - 6.0 mm ²	22 - 10 AWG
0.2 - 6.0 mm ²	22 - 10 AWG

14 mm

IEC60947-7-1 UL-1059 CSA22.2-158

1000 V	1000 V	1000 V
57 A	65 A	65 A
1.2 Nm	14 lb-in	14 lb-in



Polyamide 6,6 / 1

8 KV / 3

Type / Cat. No.	Standard Pack
CHV10U	50
CHV10UBU	50
EPUSC	50
SP2.5/4UN	50
CA701-1M / CA701-1M-S	50 m
CA701-15-1M / CA701-15-1M-S	25 m
CA702 / CA802	50
CA509/K10WHT	100
MC10	10
SCS0.8/4 Blade size: 0.8 x 4 mm	10

Type / Cat. No.	I _{max}	Standard Pack
CA625/2	57 A	100
CA625/3	57 A	100
CA625/4	57 A	100
CA625/10	57 A	10

SPRING LOADED TERMINAL BLOCKS

These modified version of feed through Terminal Blocks are fitted with springs below the clamps. These Terminal Blocks are preferred for connections that involve safety requirements of the Electric Supply Industry (ESI) standards, British CEGB regulations, SEC and NTPC applications. In addition to the high torque screws, these blocks have a built-in spring loading feature.







It is recommended to use hook type lug / ferrule for terminating wires in such connections.



These Terminal Blocks have a specially designed current bar for the right location & placement of wires crimped with hook type lug / ferrule, thus preventing loosening of the wires even when the screw clamps are not tightened.

CTS4USC, CTS6USC & CTS10USC are standard spring loaded feed through Terminal Blocks.

CDS6U/SC is spring loaded disconnect & test Terminal Block suitable for CT, PT & VT circuits.

Width (Thickness) x Length	
Height with DIN 35 x 7.5 / 35 x 15 / 32 mm Rail	
Connection Possibility as per	
With 1 Conductor per clamp	Stranded / Flexible Solid with Ferrule / Lug
With 2 same size Conductors per clamp	Stranded / Flexible with TWIN Ferrule / Lug
Wire Stripping Length	
Ratings As Per	
Voltage	
Current	
Torque	
Approvals	
Insulation Material / Material Group	
Rated Impulse Voltage / Pollution Degree	

Terminal Block	Grey Blue
End Plate	
Separator Plate	
Mounting Rail (Refer Pg. 263 for details)	
End Clamp (Refer Pg. 264 for details)	
Marking Tags (Refer Pg. 268 for details)	
Marker Card (Refer Pg. 269 for details)	
Screw Driver	

Jumpers		
Screw Type Jumpers		2 pole
		3 pole
		4 pole
		10 pole
Hook Type Lug / Ferrule		1.5 sq.mm
		2.5 sq.mm
		4 sq.mm
		6 sq.mm
		10 sq.mm

CTS4USC



6 x 52 mm			
63.4 mm / 70.8 mm / 68.2 mm			
IEC		UL - CSA	
0.2 - 4.0 mm ²		22 - 10 AWG	
0.2 - 6.0 mm ²			
0.2 - 4.0 mm ²		22 - 10 AWG	
0.2 - 2.5 mm ²		22 - 12 AWG	
0.2 - 2.5 mm ²		22 - 12 AWG	
12 mm			
IEC60947-7-1 UL-1059 CSA22.2-158			
1000 V	600 V	600 V	
32 A	35 A	35 A	
0.5 Nm	7 lb-in	7 lb-in	



Polyamide 6,6 / 1			
8 KV / 3			

Type / Cat. No.	Standard Pack
CTS4USC	50
CTS4USCBU	50
EPUSC	50
SP2.5/4UN	50
CA701-1M / CA701-1M-S	50 m
CA701-15-1M / CA701-15-1M-S	25 m
CA702 / CA802	50
CA509/K6WHT	100
MC6	10
SCS0.6/3.5 Blade size: 0.6 x 3.5 mm	10

Type / Cat. No.	I _{max}	Standard Pack
CA623/2	32 A	100
CA623/3	32 A	100
CA623/4	32 A	100
CA623/10	32 A	10
CA604/1		100
CA604/2		100
CA604/5		100

CTS6USC



8 x 52 mm

63.4 mm / 70.8 mm / 68.2 mm

IEC	UL - CSA
0.2 - 6.0 mm ²	22 - 8 AWG
0.2 - 6.0 mm ²	22 - 8 AWG
0.2 - 4.0 mm ²	22 - 10 AWG
0.2 - 4.0 mm ²	22 - 10 AWG

14 mm

IEC60947-7-1 UL-1059 CSA22.2-158

1000 V	1000 V	1000 V
41 A	50 A	50 A
0.8 Nm	14 lb-in	14 lb-in



Polyamide 6,6 / 1

8 KV / 3

Type / Cat. No.	Standard Pack
CTS6USC	50
CTS6USCUB	50
EPUSC	50
SP2.5/4UN	50
CA701-1M / CA701-1M-S	50 m
CA701-15-1M / CA701-15-1M-S	25 m
CA702 / CA802	50
CA509/K6WHT	100
MC6	10
SCS0.6/3.5 Blade size: 0.6 x 3.5 mm	10

Type / Cat. No.	I _{max}	Standard Pack
CA624/2	41 A	100
CA624/3	41 A	100
CA624/4	41 A	100
CA624/10	41 A	10
CA604/1		100
CA604/2		100
CA604/5		100
CA604/3		100

CTS10USC



10 x 52 mm

63.4 mm / 70.8 mm / 68.2 mm

IEC	UL - CSA
0.2 - 10.0 mm ²	20 - 6 AWG
0.2 - 10.0 mm ²	20 - 6 AWG
0.2 - 6.0 mm ²	20 - 8 AWG
0.2 - 6.0 mm ²	20 - 8 AWG

14 mm

IEC60947-7-1 UL-1059 CSA22.2-158

1000 V	1000 V	1000 V
57 A	65 A	65 A
1.2 Nm	14 lb-in	14 lb-in



Polyamide 6,6 / 1

8 KV / 3

Type / Cat. No.	Standard Pack
CTS10USC	50
EPUSC	50
SP2.5/4UN	50
CA701-1M / CA701-1M-S	50 m
CA701-15-1M / CA701-15-1M-S	25 m
CA702 / CA802	50
CA509/K10WHT	100
MC10	10
SCS0.8/4 Blade size: 0.8 x 4 mm	10

Type / Cat. No.	I _{max}	Standard Pack
CA625/2	57 A	100
CA625/3	57 A	100
CA625/4	57 A	100
CA625/10	57 A	10
CA604/1		100
CA604/2		100
CA604/5		100
CA604/4		100
CA604/3		100

CDS6U/SC

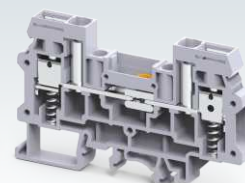

8 x 82 mm

51.0 mm / 59.2 mm / 56.7 mm

IEC	UL - CSA
0.2 - 6.0 mm ²	22 - 8 AWG
0.2 - 6.0 mm ²	22 - 8 AWG
0.2 - 4.0 mm ²	22 - 10 AWG
0.2 - 4.0 mm ²	22 - 10 AWG

10 mm

IEC60947-7-1 UL-1059 CSA22.2-158

800 V	600 V	600 V
41 A	45 A	45 A
0.8 Nm	14 lb-in	14 lb-in



Polyamide 6,6 / 1

8 KV / 3

Type / Cat. No.	Standard Pack
CDS6U/SC	50
EPCDS6U	50
CA701-1M / CA701-1M-S	50 m
CA701-15-1M / CA701-15-1M-S	25 m
CA702 / CA802	50
CA509/K8WHT	100
MC8	10
SCS0.8/4 Blade size: 0.8 x 4 mm	10

Type / Cat. No.	I _{max}	Standard Pack
CA723/2	41 A	100
CA723/3	41 A	50
CA723/4	41 A	50
CA723/10	41 A	50
CA604/1		100
CA604/2		100
CA604/5		100
CA604/3		100

Note:
For other accessories for CDS6U
please refer page 171.

SPRING LOADED TERMINAL BLOCKS

CKT4SPSC is spring loaded knife disconnect Terminal Block. Disconnection of circuit is achieved by lifting a lever which operates the knife contact.

In CDTTUSC terminal the disconnection is achieved by means of a slide link operated with a screw driver.

CDTTUFTSC is standard spring loaded feed through Terminal Block in the same profile as that of CDTTUSC.

CKT4SPSC

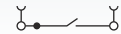
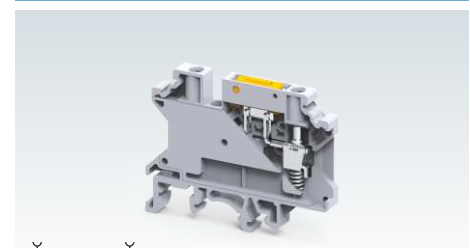

Width (Thickness) x Length	6 x 58.5 mm				
Height with DIN 35 x 7.5 / 35 x 15 / 32 mm Rail	46.0 mm / 53.5 mm / 51.5 mm				
Connection Possibility as per	IEC		UL - CSA		
With 1 Conductor per clamp	Stranded / Flexible	0.2 - 4.0 mm ²	24 - 10 AWG		
	Solid with Ferrule / Lug	0.2 - 6.0 mm ²	24 - 10 AWG		
With 2 same size Conductors per clamp	Stranded / Flexible	0.2 - 4.0 mm ²	24 - 10 AWG		
	with TWIN Ferrule / Lug	0.2 - 2.5 mm ²	24 - 12 AWG		
Wire Stripping Length	8 mm				
Ratings As Per	IEC60947-7-1	UL-1059	CSA22.2-158		
Voltage	1000 V	600 V	600 V		
Current	28 A	30 A	30 A		
Torque	0.5 Nm	4.5 lb-in	4.5 lb-in		
Approvals					
Insulation Material / Material Group	Polyamide 6,6 / 1				
Rated Impulse Voltage / Pollution Degree	8 KV / 3				
	Type / Cat. No.		Standard Pack		
Terminal Block	CKT4SPSC		50		
End Plate					
Mounting Rail (Refer Pg. 263 for details)	CA701-1M / CA701-1M-S		50 m		
End Clamp (Refer Pg. 264 for details)	CA701-15-1M / CA701-15-1M-S		25 m		
End Clamp (Refer Pg. 264 for details)	CA702 / CA802		50		
Marking Tags (Refer Pg. 268 for details)	CA509/K6WHT		100		
Marker Card (Refer Pg. 269 for details)	MC6		10		
Screw Driver	SCS0.6/3.5 Blade size: 0.6 x 3.5 mm		10		
Jumpers	Uninsulated	Insulated	I_{max}	Standard Pack	
Screw Type Jumpers	2 pole	CA722/2	CA742/2	28 A	100
	3 pole	CA722/3	CA742/3	28 A	100
	4 pole	CA722/4	CA742/4	28 A	100
	10 pole	CA722/10	CA742/10	28 A	10
External Jumpers	2 pole		CA714/2	28 A	100
	3 pole		CA714/3	28 A	100
	4 pole		CA714/4	28 A	100
	10 pole		CA714/10	28 A	20
Shorting Plug					

CDTTUSC

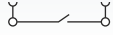
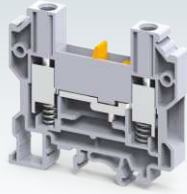

8 x 63 mm

58.7 mm / 65.7 mm / 63.7 mm

IEC	UL - CSA
1.5 - 10.0 mm ²	16 - 8 AWG
1.5 - 10.0 mm ²	16 - 8 AWG
1.5 - 4.0 mm ²	16 - 10 AWG
1.5 - 4.0 mm ²	16 - 10 AWG

12 mm

IEC60947-7-1 UL-1059 CSA22.2-158

800 V	600 V	600 V
57 A	41 A	41 A
1.2 Nm	14 lb-in	14 lb-in



Polyamide 6,6 / 1

8 KV / 3

Type / Cat. No.	Standard Pack	
CDTTUSC	50	
EPCDTTU	50	
CA701-1M / CA701-1M-S	50 m	
CA701-15-1M / CA701-15-1M-S	25 m	
CA702 / CA802	50	
CA509/K8WHT	100	
MC8	10	
SCS1.0/5.5 Blade size: 1.0 x 5.5 mm	10	
Type / Cat. No.	I _{max}	Standard Pack
CA710/2	35 A	100
CA710/3	35 A	50
CA710/4	35 A	50
CA710/10	35 A	20
QJ8/2		25

CDTTUFTSC

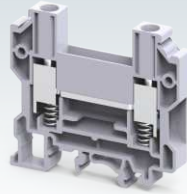

8 x 63 mm

58.7 mm / 65.7 mm / 63.7 mm

IEC	UL - CSA
1.5 - 10.0 mm ²	16 - 8 AWG
1.5 - 10.0 mm ²	16 - 8 AWG
1.5 - 4.0 mm ²	16 - 10 AWG
1.5 - 4.0 mm ²	16 - 10 AWG

12 mm

IEC60947-7-1 UL-1059 CSA22.2-158

800 V	600 V	600 V
57 A	41 A	41 A
1.2 Nm	14 lb-in	14 lb-in



Polyamide 6,6 / 1

8 KV / 3

Type / Cat. No.	Standard Pack	
CDTTUFTSC	50	
EPCDTTU	50	
CA701-1M / CA701-1M-S	50 m	
CA701-15-1M / CA701-15-1M-S	25 m	
CA702 / CA802	50	
CA509/K8WHT	100	
MC8	10	
SCS1.0/5.5 Blade size: 1.0 x 5.5 mm	10	
Type / Cat. No.	I _{max}	Standard Pack
CA710/2	35 A	100
CA710/3	35 A	50
CA710/4	35 A	50
CA710/10	35 A	20

MICRO TERMINAL BLOCKS

These Terminal Blocks are extremely compact and are used in applications with space constraints. These blocks should be used with DIN 15 type (DIN 2) rails.

CMT4 Terminal Blocks can be shorted with the help of screw type jumpers.

CMT10 Terminal Blocks can be shorted with standard JY pluggable jumpers.

The terminals with  & IECEx approval can be used in potentially explosive atmosphere. For detailed information refer page 289.

Width (Thickness) x Length	6 x 27 mm			
Height with DIN 15 mm Rail	30.4 mm			
Connection Possibility as per	IEC		UL - CSA	
With 1 Conductor per clamp	Stranded / Flexible	0.2 - 4.0 mm ²	22 - 10 AWG	
	Solid	0.2 - 6.0 mm ²		
With 2 same size Conductors per clamp	with Ferrule / Lug	0.2 - 4.0 mm ²	22 - 10 AWG	
	Stranded / Flexible	0.2 - 2.5 mm ²	22 - 12 AWG	
with TWIN Ferrule / Lug	0.2 - 2.5 mm ²	22 - 12 AWG		
Wire Stripping Length	8 mm			
Ratings As Per	IEC60947-7-1	UL-1059	CSA22.2-158	IEC 60079-7
Voltage	500 V	300 V	300 V	380 V
Current	32 A	35 A	35 A	28 A
Torque	0.5 Nm	7 lb-in	7 lb-in	0.5 Nm
Approvals				
Insulation Material / Material Group	Polyamide 6,6 / 1			
Rated Impulse Voltage / Pollution Degree	4 KV / 3			

CMT4



		Type / Cat. No.	Standard Pack
Terminal Block	Grey	CMT4	100
	Blue	CMT4BU	100
	Red	CMT4R	100
	Yellow	CMT4Y	100
	Black	CMT4BK	100
	Green	CMT4GN	100
	Ground / Earth	CGMT4 (Refer Pg. 156 for details)	100
	End Plate	EPCMT4	50
Partition Plate	PPCMT4	50	
Mounting Rail (Refer Pg. 263 for details)	CA601	100 m	
End Clamp (Refer Pg. 264 for details)	CA602	50	
Marking Tags (Refer Pg. 268 for details)	CA509/K2WHT	100	
Marker Card (Refer Pg. 269 for details)	MC2	10	
Screw Driver	SCS0.6/3.5 Blade size: 0.6 x 3.5 mm	10	

Jumpers		Uninsulated	Insulated	Imax	Standard Pack
Screw Type Jumpers	2 pole	CA727/2	CA747/2	32 A	100
	3 pole	CA727/3	CA747/3	32 A	100
	4 pole	CA727/4	CA747/4	32 A	100
	10 pole	CA727/10	CA747/10	32 A	10
	100 pole				
Jumper Bar	2 pole	CA703/1		32 A	100
	3 pole	CA704/1		32 A	100
	4 pole	CA705/1		32 A	100
	10 pole	CA732/10		32 A	100
	10 pole (Breakable)	CA732/10-A		32 A	100
	100 pole	CA732/100		32 A	10
Short Sleeve & Screw for configurable jumper bar		CA607/S/Q			100
Switchable Jumpers		CA706/1		32 A	100
Long Sleeve & Screw for Switchable Jumpers		CA607/L/Q			100
External Jumpers	2 pole		CA714/2	25 A	100
	3 pole		CA714/3	25 A	100
	4 pole		CA714/4	25 A	100
	10 pole		CA714/10	25 A	20
Pluggable Jumper					100
Test Socket		CA707/TS/03			

CMT10



10 x 33.5 mm

36 mm

IEC	UL - CSA
0.2 - 10.0 mm ²	24 - 6 AWG
0.2 - 10.0 mm ²	24 - 6 AWG

12 mm

IEC60947-7-1 UL-1059

500 V	150 V		
57 A	65 A		
1.2 Nm	14 lb-in		



Polyamide 6,6 / 1

4 KV / 3

Type / Cat. No.	Standard Pack
CMT10	100

EPCMT10	50
---------	----

CA601	100 m
CA602	50
CA509/K10WHT	100
MC10	10
SCS0.8/4.0 Blade size: 0.8 x 4.0 mm	10

Uninsulated	Insulated	Imax	Standard Pack

--	--	--	--

JY10/2 45 A 20

--	--	--	--

PANEL MOUNT TERMINAL BLOCK





A perfect solution for extremely compact wiring applications, these Terminal Blocks are modular and can be stacked to form multi-pole Terminal Block assemblies. The stacked assemblies are fitted with mounting End Plates on both ends for easy installations.

M3 screw of desired length can be used for mounting.

The terminals with  & IECEx approval can be used in potentially explosive atmosphere. For detailed information refer page 289.

CMB4







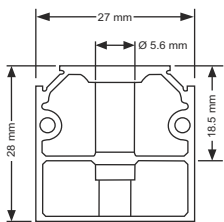

Width (Thickness) x Length	6 x 27 mm			
Height	28.5 mm			
Connection Possibility as per	IEC		UL - CSA	
With 1 Conductor per clamp	Stranded / Flexible	0.2 - 4.0 mm ²	22 - 10 AWG	
	Solid	0.2 - 6.0 mm ²		
With 2 same size Conductors per clamp	with Ferrule / Lug	0.2 - 4.0 mm ²	22 - 10 AWG	
	Stranded / Flexible	0.2 - 2.5 mm ²	22 - 12 AWG	
with TWIN Ferrule / Lug	0.2 - 2.5 mm ²	22 - 12 AWG		
Wire Stripping Length	8 mm			
Ratings As Per	IEC60947-7-1	UL-1059	CSA22.2-158	IEC 60079-7
Voltage	500 V	300 V	300 V	440 V
Current	32 A	30 A	35 A	28 A
Torque	0.5 Nm	7 lb-in	7 lb-in	0.5 Nm
Approvals				
Insulation Material / Material Group	Polyamide 6,6 / 1			
Rated Impulse Voltage / Pollution Degree	4 KV / 3			
	Type / Cat. No.		Standard Pack	
Terminal Block	Grey	CMB4	100	
	Blue	CMB4BU	100	
	Red	CMB4R	100	
	Yellow	CMB4Y	100	
	Black	CMB4BK	100	
	Green	CMB4GN	100	
	Orange	CMB4O	100	
	White	CMB4W	100	
	End Plate		EPCMB4	50
Separator Plate		SPCMB4	50	
Marking Tags (Refer Pg. 268 for details)		CA509/K2WHT	100	
Marker Card (Refer Pg. 269 for details)		MC2	10	
Screw Driver		SCS0.6/3.5	Blade size: 0.6 x 3.5 mm	10

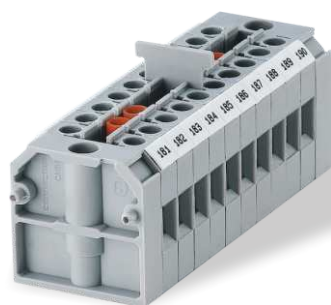
Note: It is recommended to use additional End Plate after every 20 Terminal Blocks in a stacked assembly.



End Plate



Jumpers						
Screw Type Jumpers		2 pole	CA727/2	CA747/2	32 A	100
		3 pole	CA727/3	CA747/3	32 A	100
		4 pole	CA727/4	CA747/4	32 A	100
		10 pole	CA727/10	CA747/10	32 A	10
		100 pole				
Jumper Bar		2 pole	CA703/1		32 A	100
		3 pole	CA704/1		32 A	100
		4 pole	CA705/1		32 A	100
		10 pole	CA732/10		32 A	100
		10 pole (Breakable)	CA732/10-A		32 A	100
		100 pole	CA732/100		32 A	10
		Short Sleeve & Screw for configurable jumper bar		CA607/S/Q		
External Jumpers		2 pole		CA714/2	25 A	100
		3 pole		CA714/3	25 A	100
		4 pole		CA714/4	25 A	100
		10 pole		CA714/10	25 A	20
Test Socket		CA707/TS/01			100	
Pluggable Jumpers						

CMB10



10 x 33.5 mm

34.3 mm

IEC	UL - CSA
0.2 - 10.0 mm ²	24 - 6 AWG
0.2 - 10.0 mm ²	24 - 6 AWG

12 mm

IEC60947-7-1 UL-1059

800 V	600 V		
57 A	65 A		
1.2 Nm	14 lb-in		



Polyamide 6,6 / 1

4 KV / 3

Type / Cat. No.	Standard Pack	
CMB10	100	
EPCMB10	50	
CA509/K10WHT	100	
MC10	10	
SCS0.8/4	Blade size: 0.8 x 4 mm	10

Uninsulated	Insulated	I _{max}	Standard Pack
JY10/2		45 A	20

THERMOCOUPLE TERMINAL BLOCKS

These Terminal Blocks are used with thermocouple wires in measurement applications.

As per DIN 43713 & DIN 43714 the current carrying element of the Terminal Block is made of the same material as the Thermocouple wire. These special current carrying elements ensure that there is no loss of potential at the connecting points.

The following types of Thermocouple wires can be connected using standard Thermocouple Terminal Blocks

'K' type - Chromel (Ni/Cr), Alumel (Ni/Al)

'J' type - Iron (Fe), Constantan (Cu/Ni)

'T' type - Copper (Cu), Constantan (Cu/Ni)

'E' type - Chromel (Ni/Cr), Constantan (Cu/Ni)

CTT2.5U

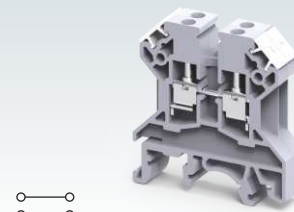

Width (Thickness) x Length	10 x 43 mm		
Height with DIN 35 x 7.5 / 35 x 15 / 32 mm Rail	46.2 mm / 53.7 mm / 51.1 mm		
Connection Possibility as per	IEC	UL - CSA	
With 1 Conductor per clamp	Stranded / Flexible	0.2 - 2.5 mm ²	22 - 14 AWG
	Solid	0.2 - 4.0 mm ²	22 - 12 AWG
	with Ferrule / Lug	0.2 - 2.5 mm ²	22 - 14 AWG
With 2 same size Conductors per clamp	Stranded / Flexible	0.2 - 1.5 mm ²	22 - 16 AWG
	with TWIN Ferrule / Lug	0.2 - 1.5 mm ²	22 - 16 AWG
Wire Stripping Length	8 mm		
Ratings As Per	IEC60947-7-1		
Voltage	1000 V		
Current	10 A		
Torque	0.4 Nm		
Approvals			
Insulation Material / Material Group	Polyamide 6,6 / 1		
Rated Impulse Voltage / Pollution Degree	4 KV / 3		
	Type / Cat. No.	Suitable for Thermocouple Wire	Standard Pack
Terminal Block	CTT2.5UK	K Type	50
	CTT2.5UJ	J Type	50
	CTT2.5UT	T Type	50
	CTT2.5UE	E Type	50
End Plate	EP2.5/4UN		50
Partition Plate	PP2.5/4UN		50
Separator Plate	SP2.5/4UN		100
Mounting Rail (Refer Pg. 263 for details)	CA701-1M / CA701-1M-S		50 m
	CA701-15-1M / CA701-15-1M-S		25 m
End Clamp (Refer Pg. 264 for details)	CA702 / CA802		50
Marking Tags (Refer Pg. 268 for details)	CA509/K5WHT		100
Marker Card (Refer Pg. 269 for details)	MC5		10
Screw Driver	SCS0.5/3	Blade size: 0.5 x 3.0 mm	10

Typical Temperature Measuring circuit

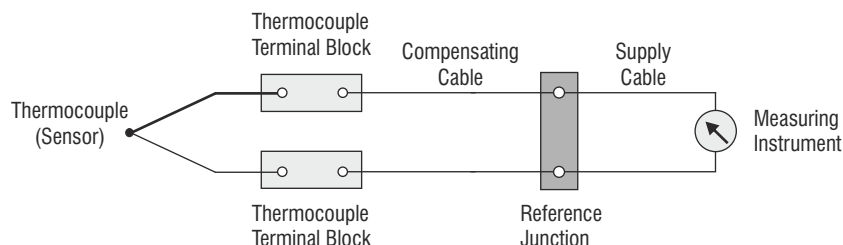

TAB CONNECTION TERMINAL BLOCKS

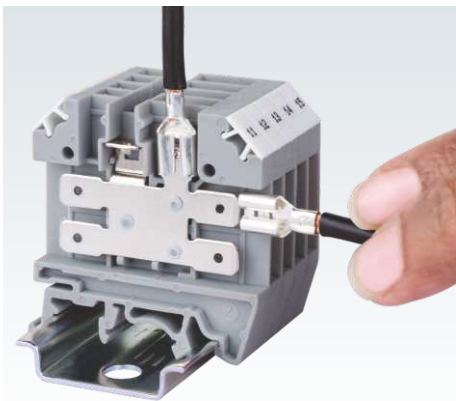

The CTC4U Tab Connection Terminal Blocks offer quick connection possibility. The Terminal Blocks are suited for standard 'Fast On' type lugs.

The connection is achieved by pushing the lug / ferrule onto the tab blade of the Terminal Block.

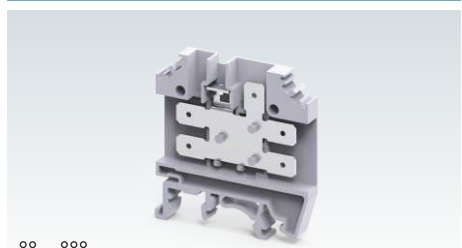

CTC4U



Width (Thickness) x Length	6 x 47 mm			
Height with DIN 35 x 7.5 / 35 x 15 / 32 mm Rail	51.2 mm / 58.8 mm / 56.3 mm			
Connection Possibility as per	IEC	UL - CSA		
With 1 Conductor per clamp	Stranded / Flexible with Ferrule / Lug	0.2 - 4.0 mm ²	24 - 12 AWG	
With 2 same size Conductors per clamp	Stranded / Flexible	0.2 - 2.5 mm ²	24 - 12 AWG	
Wire Stripping Length	9 mm			
Ratings As Per	IEC60947-7-1			
Voltage	300 V			
Current	32 A			
Approvals	 			
Insulation Material / Material Group	Polyamide 6,6 / 1			
Rated Impulse Voltage / Pollution Degree	2.5 KV / 3			
	Type / Cat. No.	Standard Pack		
Terminal Block	CTC4U	100		
End Plate	EPCTC4U	50		
Mounting Rail (Refer Pg. 263 for details)	CA701-1M / CA701-1M-S	50 m		
	CA701-15-1M / CA701-15-1M-S	25 m		
End Clamp (Refer Pg. 264 for details)	CA702 / CA802	50		
Marking Tags (Refer Pg. 268 for details)	CA509/K6WHT	100		
Marker Card (Refer Pg. 269 for details)	MC6	10		
	Jumpers	Imax	Standard Pack	
Permanent Jumpers	2 pole	CA703/1	32 A	100
	3 pole	CA704/1	32 A	100
	4 pole	CA705/1	32 A	100
	10 pole	CA732/10	32 A	100
	100 pole	CA732/100	32 A	10
Short Sleeve & Screw for Permanent Jumpers		CA807/S/Q/01		100
Test Socket		CA707/TS/01		100

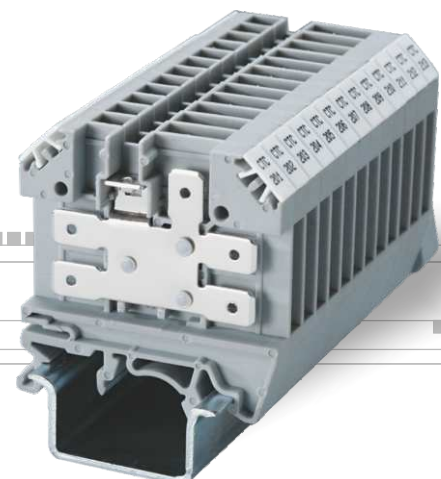

TERMINAL BLOCKS WITH ELECTRONIC COMPONENTS

The following Standard Active Terminal Blocks are available:

Diode / Resistor Terminal Blocks

Terminal Blocks with Light Indication

CDL4U(O) - Connectwell Double Level Terminal Blocks are available with open current bars at the bottom level to which the electronic components can be soldered.

CDL4USP - Spacers can be used for covering custom electronic components, which may protrude from the CDL4U(O) Terminal Block.

Width (Thickness) x Length	6 x 55.5 mm		
Height with DIN 35 x 7.5 / 35 x 15 / 32 mm Rail	55.7 mm / 63.1 mm / 60.3 mm		
Connection Possibility as per	IEC	UL - CSA	
With 1 Conductor per clamp	Stranded / Flexible	0.2 - 4.0 mm ²	22 - 10 AWG
	Solid with Ferrule / Lug	0.2 - 6.0 mm ²	
With 2 same size Conductors per clamp	Stranded / Flexible	0.2 - 4.0 mm ²	22 - 10 AWG
	with TWIN Ferrule / Lug	0.2 - 2.5 mm ²	22 - 12 AWG
Wire Stripping Length	9 mm		
Ratings As Per	IEC60947-7-1	UL-1059	CSA22.2-158
Voltage	500 V	600 V	300 V
Current	32 A	35 A	25 A
Torque	0.5 Nm	7 lb-in	7 lb-in
Approvals			
Insulation Material / Material Group	Polyamide 6,6 / 1		
Diode	1N 4007		
Diode Reverse Voltage / Current	1000 V / 1 A		

	Type / Cat. No.	Standard Pack
End Plate	EPCDL4U	50
Spacer	CDL4USP	50
Mounting Rail (Refer Pg. 263 for details)	CA701-1M / CA701-1M-S	50 m
	CA701-15-1M / CA701-15-1M-S	25 m
Marking Tags (Refer Pg. 268 for details)	CA509/K2WHT	100
Marker Card (Refer Pg. 269 for details)	MC2	100
Screw Driver	SCS0.6/3.5 Blade size: 0.6 x 3.5 mm	10

Jumpers	Type / Cat. No.	Imax	Standard Pack	
Screw Type Jumpers	2 pole	CA703/1	32 A	100
	3 pole	CA704/1	32 A	100
	4 pole	CA705/1	32 A	100
	10 pole	CA732/10	32 A	100
Short Sleeve & Screw for configurable jumper bar	CA607/S/Q		100	

Part No.	Application	Std. Pack
CDL4UED1	Arc suppression circuit for contactors & solenoid valves - D.C	100

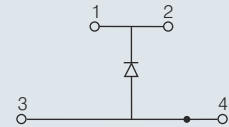

Part No.	Application	Std. Pack
CDL4UED2	Arc suppression circuit for contactors & solenoid valves - D.C	100

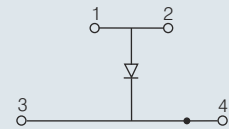

Part No.	Application	Std. Pack
CDL4UED3	Diode circuit for reverse polarity protection	100

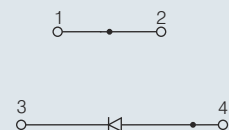

Part No.	Application	Std. Pack
CDL4UEDD1	Diode circuit for lamp testing	100

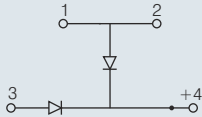

Part No.	Application	Std. Pack
CDL4UEDD2	Diode circuit for lamp testing	100

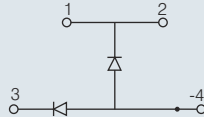

Part No.	Application	Std. Pack
CDL4UEDD3	Diode circuit for lamp testing	100

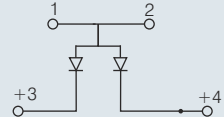

Part No.	Application	Std. Pack
CDL4UEDD4	Diode circuit for lamp testing	100

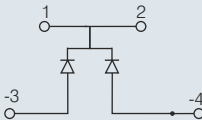

Part No.	Application	Std. Pack
CDL4UED4	Diode circuit for lamp testing with LED series resistance	100

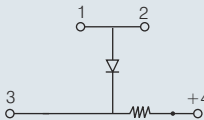

Part No.	Application	Std. Pack
CDL4UEDD5	Diode circuit for lamp testing with LED series resistance	100

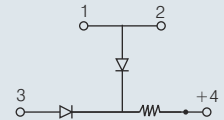

Part No.	Application	Std. Pack
CKT4UD1	Arc suppression circuit for contactors & solenoid valves - D.C	100



Part No.	Application	Std. Pack
CKT4UD2	Arc suppression circuit for contactors & solenoid valves - D.C	100



Part No.	Diode Type	Std. Pack
CF4SPD1	1N4007	50
CF4SPD2	1N5408	50
CF4SPD3	1N5820	50

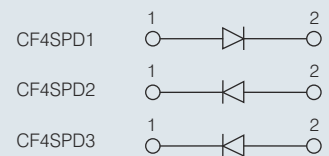
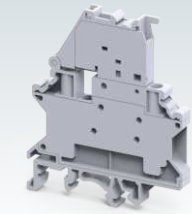

Part No.	Application	Std. Pack
CDL4UEN1	AC Voltage indicator with Neon lamp	100

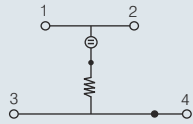

Part No.	Application	Std. Pack
CDL4UELD5	AC Voltage indicator with LED	100

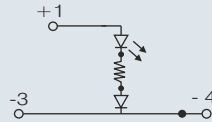
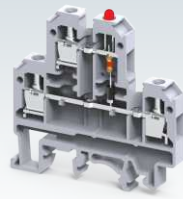

Part No.	Application	Std. Pack
CDL4UELD3	AC Voltage indicator with LED	100

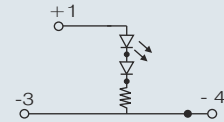
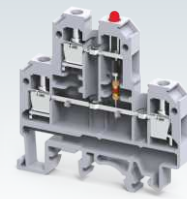

Part No.	Application	Std. Pack
CDL4UELD4	AC Voltage indicator with LED	100

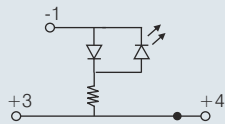
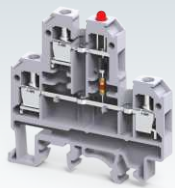

Part No.	Application	Std. Pack
CDL4UELD1	DC Voltage indicator with LED	100

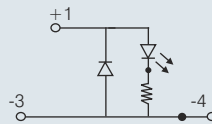
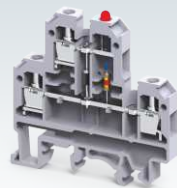

Part No.	Application	Std. Pack
CDL4UELD2	DC Voltage indicator with LED	100

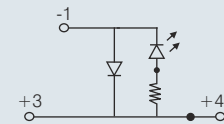
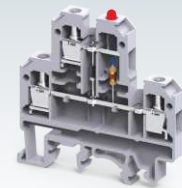

Part No.	Application	Std. Pack
CDL4UEL1	DC Voltage indicator with LED	100

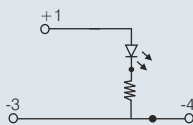
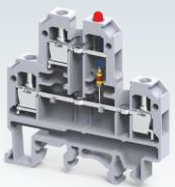

Part No.	Application	Std. Pack
CDL4UEL2	DC Voltage indicator with LED	100

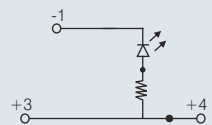

Part No.	Application	Std. Pack
CDL4U(O)	Basic terminal for soldering electronic components	100



SURGE SUPPRESSION TERMINAL BLOCKS

These Terminal Blocks are designed to protect a single line against a longitudinal (line / earth) surge, thereby protecting distribution and input.

CDL4U(E)SDU is for DC application at 48 V with current rating 3.2 A.

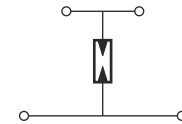

CDL4U(E)SDB is for AC application at 400 VAC with current rating 4 A.

Circuit Diagram

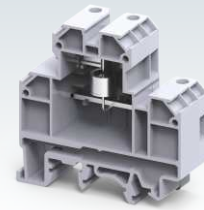

CDL4UELA



Width (Thickness) x Length	18 x 55.5 mm	
Height with DIN 35 x 7.5 / 35 x 15 / 32 mm Rail	55.7 mm / 63.1 mm / 60.3 mm	
Connection Possibility as per	IEC	UL - CSA
With 1 Conductor per clamp	Stranded / Flexible	0.2 - 4.0 mm ²
	Solid	0.2 - 6.0 mm ²
With 2 same size Conductors per clamp	with Ferrule / Lug	0.2 - 4.0 mm ²
	Stranded / Flexible	0.2 - 2.5 mm ²
with TWIN Ferrule / Lug	Stranded / Flexible	0.2 - 2.5 mm ²
	with TWIN Ferrule / Lug	0.2 - 2.5 mm ²
Wire Stripping Length	9 mm	
Type of Connection	4 Screw Clamps	
Rated Connection Capacity	0.5 - 4 sq.mm / 22-10 AWG	
Voltage Rating	75 V, 90 V, 230 V, 600 V, 1000 V DC	
Impulse Discharge Current	20 KA (8/20 μ s)	
Alternating Discharge Current at Hz	20 A	
Response Time	100 ms	
Normal Current	10 A	
Capacitance	< 1.5 pf	
Insulation Material / Material Group	Polyamide 6,6 / 1	
Approvals	 	
	Type / Cat. No.	Standard Pack
Terminal Block	CDL4UELA90V	32
End Plate	EPCDL4U	50
Spacer	CDL4USP	50
Mounting Rail (Refer Pg. 263 for details)	CA701-1M / CA701-1M-S	50 m
	CA701-15-1M / CA701-15-1M-S	25 m
End Clamp (Refer Pg. 264 for details)	CA702 / CA802 / CA202	50
Marking Tags (Refer Pg. 268 for details)	CA509/K2WHT	100
Marker Card (Refer Pg. 269 for details)	MC2	10
Screw Driver	SCS0.6/3.5 Blade size: 0.6 x 3.5 mm	10

CDL4UE3LA

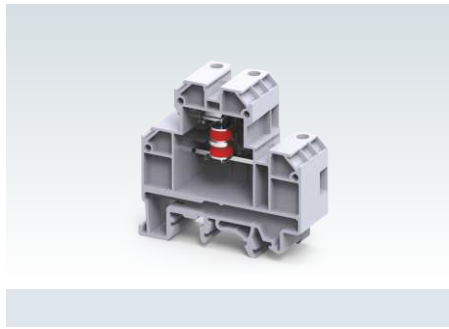

CDL4UEMOV



Circuit Diagram

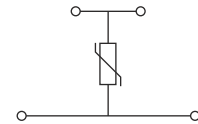
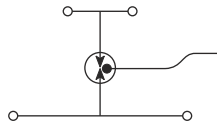

Width (Thickness) x Length	18 x 55.5 mm		12 x 55.5 mm	
Height with DIN 35 x 7.5 / 35 x 15 / 32 mm Rail	55.7 mm / 63.1 mm / 60.3 mm		55.7 mm / 63.1 mm / 60.3 mm	
Connection Possibility as per	IEC	UL - CSA	IEC	UL - CSA
With 1 Conductor per clamp	Stranded / Flexible	0.2 - 4.0 mm ²	22 - 10 AWG	0.2 - 4.0 mm ²
	Solid	0.2 - 6.0 mm ²		0.2 - 6.0 mm ²
	with Ferrule / Lug	0.2 - 4.0 mm ²	22 - 10 AWG	0.2 - 4.0 mm ²
With 2 same size Conductors per clamp	Stranded / Flexible	0.2 - 2.5 mm ²	22 - 12 AWG	0.2 - 2.5 mm ²
	with TWIN Ferrule / Lug	0.2 - 2.5 mm ²	22 - 12 AWG	0.2 - 2.5 mm ²
Wire Stripping Length	9 mm		9 mm	
Type of Connection	4 Screw Clamps		4 Screw Clamps	
Rated Connection Capacity	0.5 - 4 sq.mm / 22-10 AWG		0.5 - 4 sq.mm / 22-10 AWG	
Voltage Rating	90 V, 230 V, 350 V, 600 V DC		30 V, 60 V, 75 V, 130 V, 275 V, 460 V, 510 V, 625 V, 680 V A.C.	
Impulse Discharge Current	10 KA (8/20μs)		2 KA - 6.5 KA (8/20μs)	
Alternating Discharge Current at Hz	10 A			
Response Time	100 ms		< 25 ns	
Normal Current				
Capacitance	< 1.0 pf		100 - 20000 pf	
Insulation Material / Material Group	Polyamide 6,6 / 1		Polyamide 6,6 / 1	
Approvals				

	Type / Cat. No.	Standard Pack	Type / Cat. No.	Standard Pack
Terminal Block	CDL4UE3LA(90V)	32	CDL4UEMOV-30V CDL4UEMOV-60V	52
End Plate	EPCDL4U	50	EPCDL4U	50
Spacer	CDL4USP	50	CDL4USP	50
Mounting Rail (Refer Pg. 263 for details)	CA701-1M / CA701-1M-S CA701-15-1M / CA701-15-1M-S	50 m 25 m	CA701-1M / CA701-1M-S CA701-15-1M / CA701-15-1M-S	50 m 25 m
End Clamp (Refer Pg. 264 for details)	CA702 / CA802 / CA202	50	CA702 / CA802 / CA202	50
Marking Tags (Refer Pg. 268 for details)	CA509/K2WHT	100	CA509/K2WHT	100
Marker Card (Refer Pg. 269 for details)	MC2	10	MC2	10
Screw Driver	SCS0.6/3.5 Blade size: 0.6 x 3.5 mm	10	SCS0.6/3.5 Blade size: 0.6 x 3.5 mm	10

CTLG2.5EMOV

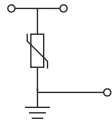
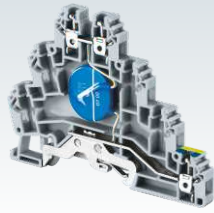

6 x 87.5 mm

66.0 mm / 74.0 mm

IEC	UL - CSA
0.2 - 2.5 mm ²	22 - 14 AWG
0.2 - 4.0 mm ²	22 - 12 AWG
0.2 - 2.5 mm ²	22 - 14 AWG
0.2 - 1.5 mm ²	22 - 16 AWG
0.2 - 1.5 mm ²	22 - 16 AWG

9 mm

3 Screw Clamps

0.5 - 2.5 sq.mm / 22-12 AWG

Upto 275 V

2 KA - 6.5 KA (8/20μs)

< 25 ns

100 - 20000 pf

Polyamide 6,6 / 1



CDL4UESD

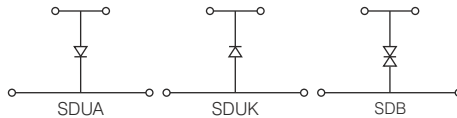

12 x 55.5 mm

55.7 mm / 63.1 mm / 60.3 mm

IEC	UL - CSA
0.2 - 4.0 mm ²	22 - 10 AWG
0.2 - 6.0 mm ²	
0.2 - 4.0 mm ²	22 - 10 AWG
0.2 - 2.5 mm ²	22 - 12 AWG
0.2 - 2.5 mm ²	22 - 12 AWG

9 mm

4 Screw Clamps

0.5 - 4 sq.mm / 22-10 AWG

12 VDC to 48 VDC / 12 VAC to 160 VAC

1.5 KA

1 ns (D.C) / 5 ns (A.C)

Polyamide 6,6 / 1



CDL4UERC

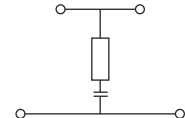
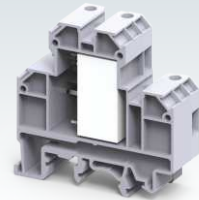

18 x 55.5 mm

55.7 mm / 63.1 mm / 60.3 mm

IEC	UL - CSA
0.2 - 4.0 mm ²	22 - 10 AWG
0.2 - 6.0 mm ²	
0.2 - 4.0 mm ²	22 - 10 AWG
0.2 - 2.5 mm ²	22 - 12 AWG
0.2 - 2.5 mm ²	22 - 12 AWG

9 mm

4 Screw Clamps

0.5 - 4 sq.mm / 22-10 AWG

250 VAC / 630 VDC

20 A

Polyamide 6,6 / 1



Type / Cat. No.	Standard Pack
CTLG2.5EMOV-275V	50
EPCTLG2.5	50
CA701-1M / CA701-1M-S	50 m
CA701-15-1M / CA701-15-1M-S	25 m
CA702 / CA802 / CA202	50
CA509/K2GWHT	100
MC2	10
SCS0.6/3.5 Blade size: 0.6 x 3.5 mm	10

Type / Cat. No.	Standard Pack
CDL4UESDUA24V	52
CDL4UESDB-160V	52
EPCDL4U	50
CDL4USP	50
CA701-1M / CA701-1M-S	50 m
CA701-15-1M / CA701-15-1M-S	25 m
CA702 / CA802 / CA202	50
CA509/K2GWHT	100
MC2	10
SCS0.6/3.5 Blade size: 0.6 x 3.5 mm	10

Type / Cat. No.	Standard Pack
CDL4UERCO-0.1MF	32
CDL4UERCO.22MF	32
EPCDL4U	50
CDL4USP	50
CA701-1M / CA701-1M-S	50 m
CA701-15-1M / CA701-15-1M-S	25 m
CA702 / CA802 / CA202	50
CA509/K2GWHT	100
MC2	10
SCS0.6/3.5 Blade size: 0.6 x 3.5 mm	10

STUD & BOLT TYPE TERMINAL BLOCKS

Stud Type Terminal Blocks are used in application subject to severe vibration. Connection is made by crimping the wire on a ring / fork lug which is screwed on to the flat current bar.



STUD & BOLT TYPE TERMINAL BLOCKS



Feed Through

213 - 222

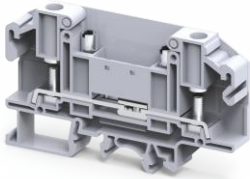

Disconnect & Test

223 - 230



Power Terminal Blocks

231 - 236

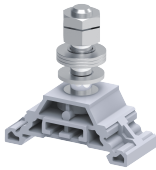

Stud Terminal Blocks - Metro Rails

237 - 239

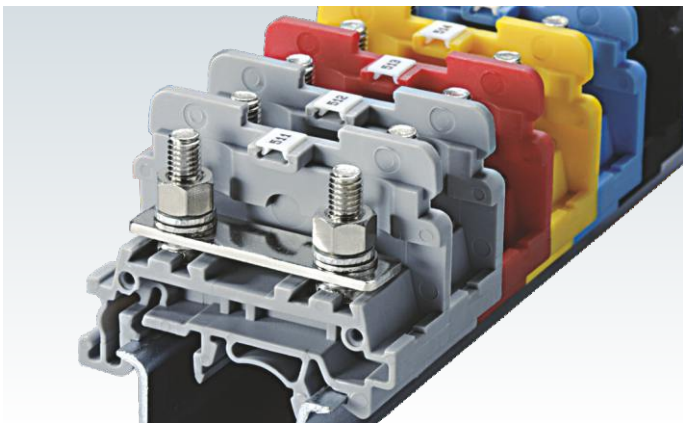

High Torque clamping system for ring & fork type lugs / ferrules. Extremely effective clamping system for areas prone to high vibrations.

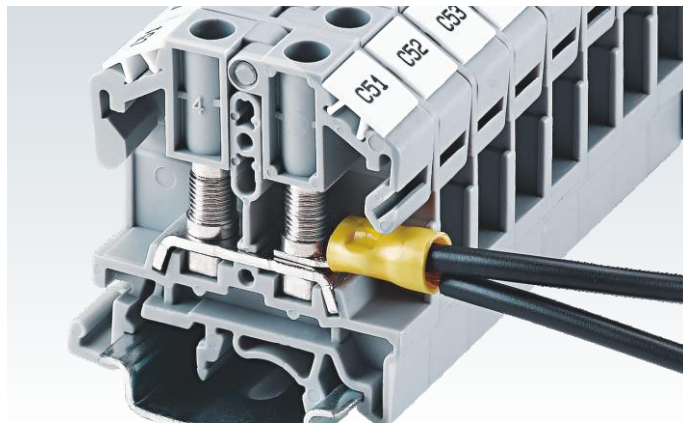

Multiple wires can be connected on a single clamping point. The bolt & nut system make these multi wire connections safe and secure.

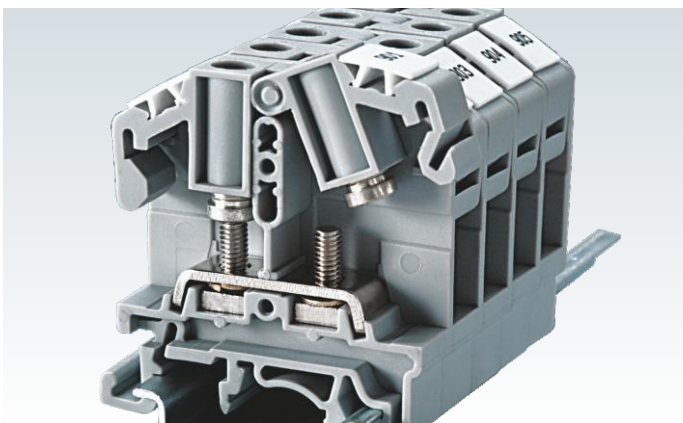

The fastening nut remains captive in the hinged plastic carrier. The nut is tightened by using a standard screwdriver.

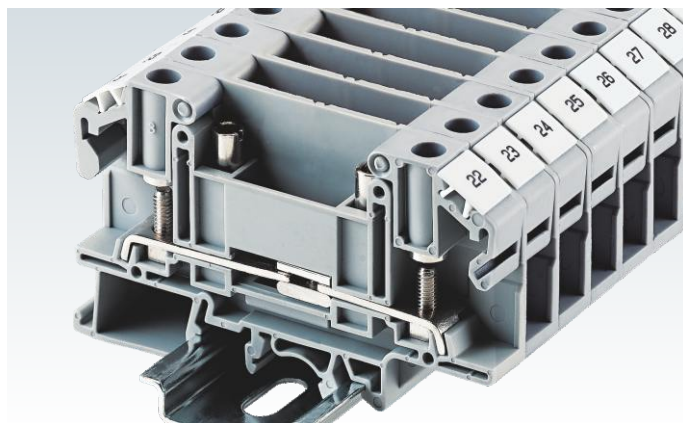

Disconnecting Terminal Block system is a versatile wire connection method for current transformer and power meters. A wide range of accessories eases the testing of these connected instruments.

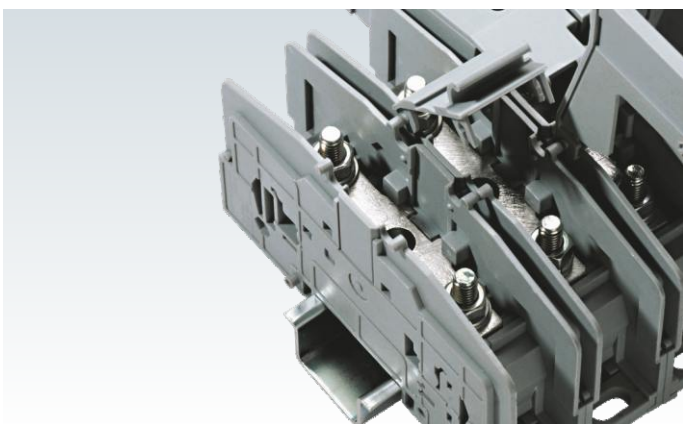

High current Terminal Blocks with a captive bolt provide extremely reliable connection for higher size wires. Integral isolation plates make these terminals extremely safe.

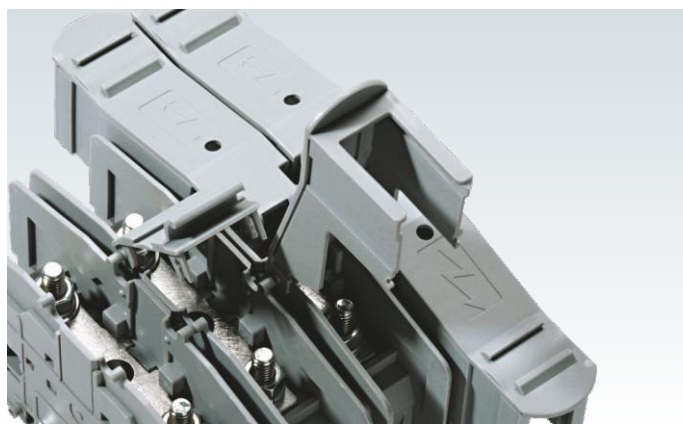

All open connection stud type Terminal Blocks can be covered with a protective shroud. The resulting assemblies are completely shock proof.

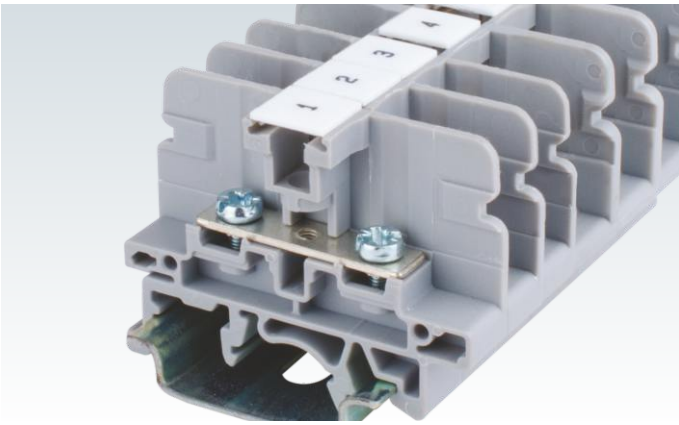

Barrier type Terminal Block CBS Series are an ideal choice for quick wire connection with ring & fork type lugs. Terminals can be interconnected using standard shorting accessories.

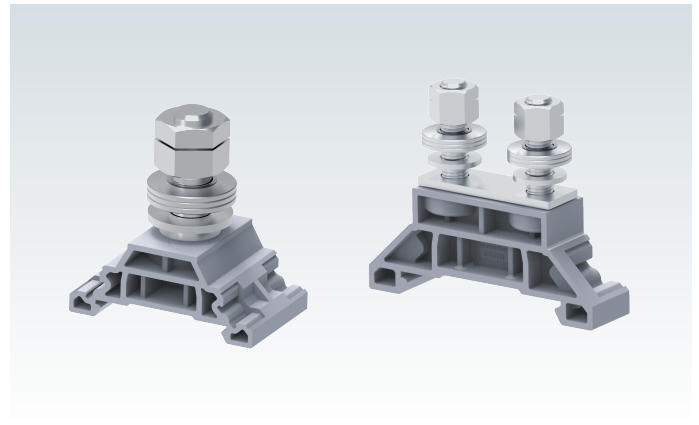

Single & Double Stud Terminal Blocks ranging from 1.5 - 120 sq.mm for harsh shock and vibration applications, such as high-speed transportation areas like metro rails.

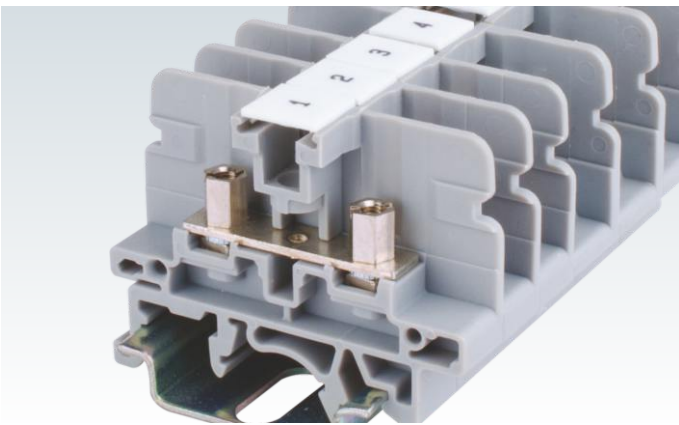

CSB series standard stud type terminals can be operated with screw / nut driver. Circuit identification can be achieved with standard marking tags.



Single Stud Diode Terminal Blocks with heat sink for protection in metro railway applications.

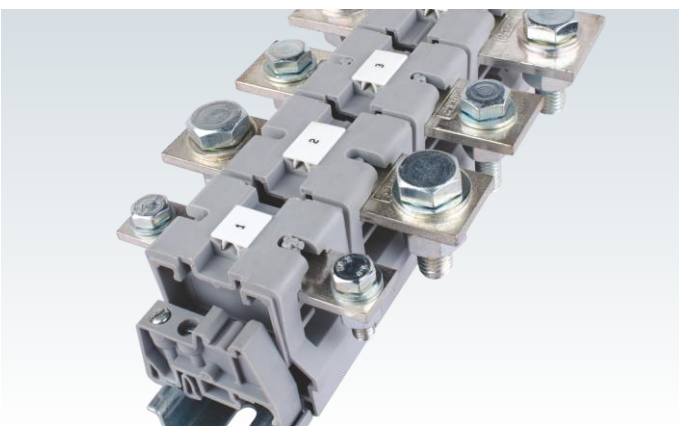

High current Bus Bar Terminal Blocks are available upto 185sq.mm cable connections.

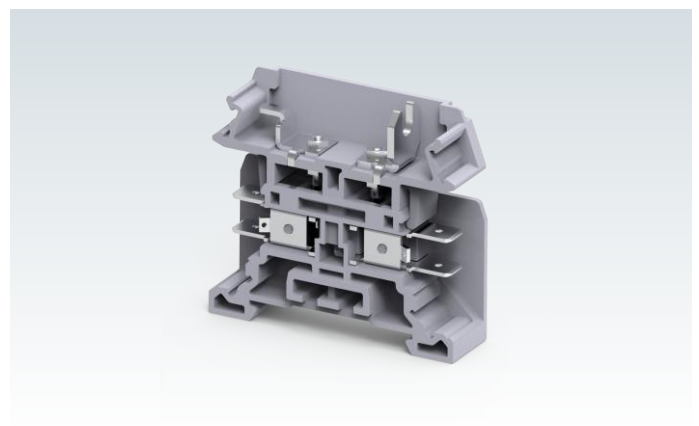

Component holder Terminal Blocks available in tab connection.

FEED THROUGH TERMINAL BLOCKS

STH Series Terminal Blocks are preferred for application where the connections are subjected to severe vibration. The wire is crimped to a ring / fork lug and is screwed on to the flat current bar of the Terminal Block. The fastening nut always remains captive in the hinged plastic carrier. The hinged carrier should be lifted to insert the lugged / crimped wire and then snapped back into position. The nut can then be fastened to complete the connection. The nut can be operated by using a standard screwdriver.

These Terminal Blocks have IP20 (Finger Safe) protection & do not need any additional shrouding.

Two Lugs can be connected to the Terminal, without sacrificing the safety of the Terminal Block.

STH4TP terminals have socket headed screws to accept standard Ø4.3 mm test plugs.

In STH3 & STH6 terminals internal screw type jumpers can be used for cross connection. This is in addition to the available external jumpers.

The terminals with  & IECEx approval can be used in potentially explosive atmosphere. For detailed information refer page 289.

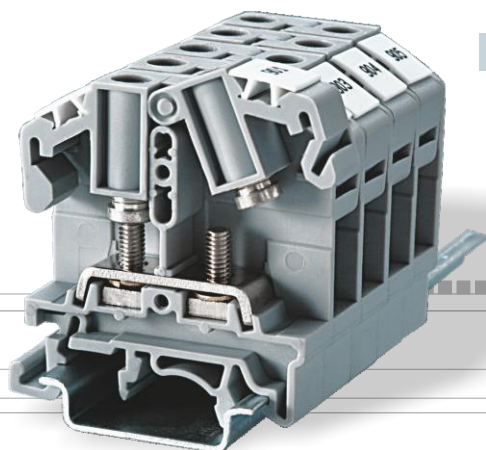













STH3











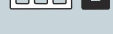

Width (Thickness) x Length		9 x 47 mm	
Height with DIN 35 x 7.5 / 35 x 15 / 32 mm Rail		47.25 mm / 54.75 mm / 52.1 mm	
Connection Possibility as per			
With 1 Conductor per clamp	Stranded / Flexible with Ferrule / Lug		
	Solid with Ferrule / Lug		
With 2 same size Conductors per clamp	Stranded / Flexible with Ferrule / Lug		
Ratings As Per			
Voltage		1000 V 600 V 600 V 630 V	
Current		41 A 50 A 50 A 36 A	
Torque		0.5 Nm 4.5 lb-in 4.5 lb-in 0.5 Nm	
Approvals			
Insulation Material / Material Group		Polyamide 6,6 / 1	
Rated Impulse Voltage / Pollution Degree		8 kV / 3	

IEC		UL - CSA	
1.5 - 6.0 mm ²		22 - 8 AWG	
1.5 - 6.0 mm ²		22 - 8 AWG	
IEC60947-1	UL-1059	CSA22.2-158	IEC60079-7
1000 V	600 V	600 V	630 V
41 A	50 A	50 A	36 A
0.5 Nm	4.5 lb-in	4.5 lb-in	0.5 Nm
			
Insulation Material / Material Group		Polyamide 6,6 / 1	
Rated Impulse Voltage / Pollution Degree		8 kV / 3	

Terminal Block	With Standard Screw	With Socket Headed Screw
End Plate		
Mounting Rail (Refer Pg. 263 for details)		
End Clamp (Refer Pg. 264 for details)		
Marking Tags (Refer Pg. 268 for details)		
Marker Card (Refer Pg. 269 for details)		
Screw Driver		
Stud Size	M3	

Type / Cat. No.	Standard Pack
STH3	100
EPSTH3	50
CA701-1M / CA701-1M-S	50 m
CA701-15-1M / CA701-15-1M-S	25 m
CA702 / CA802	50
CA509/K8WHT	100
MC8	10
SCS0.8/4	Blade size: 0.8 x 4 mm
M3	

Jumpers		
Removable Jumpers		2 pole
		3 pole
		4 pole
Permanent Jumpers		2 pole
		3 pole
		4 pole
		10 pole
Screw Type Jumpers		2 pole
		3 pole
		4 pole
		10 pole

Uninsulated	Insulated	I _{max}	Standard Pack
CA512/15-2	CA514/15-2	35 A	100
CA512/15-3	CA514/15-3	35 A	50
CA512/15-4	CA514/15-4	35 A	50
CA512/17-2	CA514/17-2	35 A	100
CA512/17-3	CA514/17-3	35 A	50
CA512/17-4	CA514/17-4	35 A	50
CA773/2		41 A	100
CA773/3		41 A	50
CA773/4		41 A	50
CA773/10		41 A	10

FEED THROUGH TERMINAL BLOCKS

CBS3U, CBS4U & CBS5U are barrier type Terminal Blocks for quick wire connection of ring & fork type lugs / ferrules.

CSB3/N3U, CSB4/N4U & CSB5/N5U terminals are standard stud type terminals. CSB3/N3UL terminal has longer barrel nut for better access. The terminals can be operated using either a screw driver or a nut driver.

All the terminals can be shorted using both external & internal jumpers.

CSB3/N3USH, CSB4/N4USH, CSB5/N5USH & CSTSN6USH terminals have built in hinged shrouds. These Terminal Blocks have IP 20 (Finger safe) protection and do not need any additional shrouding.





CSE5U Terminal Block is used for earth link disconnection application. The Terminal Block can be operated using nut driver.

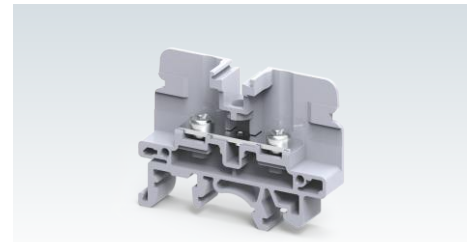



The terminals with  & IECEx approval can be used in potentially explosive atmosphere. For detailed information refer page 289.

CBS3U



Width (Thickness) x Length		9 x 49 mm			
Height with DIN 35 x 7.5 / 35 x 15 / 32 mm Rail		38 mm / 45.4 mm / 43 mm			
Connection Possibility as per		IEC		UL - CSA	
With 1 Conductor per clamp	Stranded / Flexible with Ferrule / Lug	0.5 - 6.0 mm ²		22 - 8 AWG	
With 2 same size Conductors per clamp	Stranded / Flexible with Ferrule / Lug	0.5 - 4.0 mm ²		22 - 10 AWG	
Ratings As Per		IEC60947-7-1	UL-1059	CSA22,2-158	IEC60079-7
Voltage		1000 V	600 V	600 V	500 V
Current		41 A	50 A	50 A	36 A
Torque		0.5 Nm	4.5 lb-in	4.5 lb-in	0.5 Nm
Approvals					
Insulation Material / Material Group		Polyamide 6,6 / 1			
Rated Impulse Voltage / Pollution Degree		8 KV / 3			

		Type / Cat. No.	Standard Pack
Terminal Block	Grey	CBS3U	100
	Blue	CBS3UBU	100
	Red	CBS3UR	100
	Yellow	CBS3UY	100
	Black	CBS3UBK	100
	Green	CBS3UGN	100
End Plate		EPCBS3U	50
Mounting Rail (Refer Pg. 263 for details)		CA701-1M / CA701-1M-S	50 m
		CA701-15-1M / CA701-15-1M-S	25 m
End Clamp (Refer Pg. 264 for details)		CA702 / CA802	50
Marking Tags (Refer Pg. 268 for details)		CA509/K9WHT	100
Screw Driver		SCPH2	10
Nut Driver			
Screw / Stud Size		M3	

Jumpers		Uninsulated	Insulated	I _{max}	Standard Pack	
Removable Jumpers		2 pole	CA512/15-2	CA514/15-2	35 A	100
		3 pole	CA512/15-3	CA514/15-3	35 A	50
		4 pole	CA512/15-4	CA514/15-4	35 A	50
Permanent Jumpers		2 pole	CA512/17-2	CA514/17-2	35 A	100
		3 pole	CA512/17-3	CA514/17-3	35 A	50
		4 pole	CA512/17-4	CA514/17-4	35 A	50
Screw Type Jumpers		2 pole	CA728/2		41 A	50
		3 pole	CA728/3		41 A	50
		4 pole	CA728/4		41 A	50
		10 pole	CA728/10		41 A	10
Protective Cover		2 Terminal	CSTSPC2			10
		3 Terminal	CSTSPC2-1			10
Long Protective Cover		100 mm	CSTSPC1-2			10
		200 mm	CSTSPC1-3			10
		300 mm	CSTSPC1-4			10

CBS4U

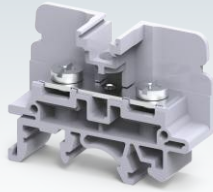

13 x 49 mm
38 mm / 45.4 mm / 43 mm

IEC	UL - CSA
1.5 - 10.0 mm ²	16 - 6 AWG

1.5 - 6.0 mm ²	16 - 8 AWG
---------------------------	------------

IEC60947-7-1	UL-1059	CSA22.2-158	IEC60079-7
1000 V	600 V	600 V	500 V
57 A	65 A	65 A	52 A
1.2 Nm	10 lb-in	10 lb-in	1.2 Nm



Polyamide 6,6 / 1

8 KV / 3

CBS5U

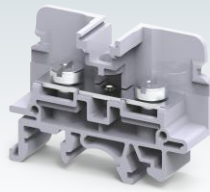

13 x 49 mm
38 mm / 45.4 mm / 43 mm

IEC	UL - CSA
1.5 - 16.0 mm ²	16 - 4 AWG

1.5 - 10.0 mm ²	16 - 6 AWG
----------------------------	------------

IEC60947-7-1	UL-1059	CSA22.2-158	IEC60079-7
1000 V	600 V	600 V	630 V
76 A	85 A	85 A	68 A
2.0 Nm	25 lb-in	25 lb-in	2.0 Nm



Polyamide 6,6 / 1

8 KV / 3

CSB3/N3U

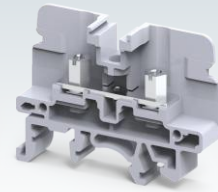

9 x 49 mm
38 mm / 45.4 mm / 43 mm

IEC	UL - CSA
0.5 - 6.0 mm ²	22 - 8 AWG

0.5 - 4.0 mm ²	22 - 10 AWG
---------------------------	-------------

IEC60947-7-1	UL-1059	CSA22.2-158	IEC60079-7
1000 V	600 V	600 V	500 V
41 A	50 A	50 A	36 A
0.5 Nm	4.5 lb-in	4.5 lb-in	0.5 Nm



Polyamide 6,6 / 1

8 KV / 3

Type / Cat. No.	Standard Pack
CBS4U	100
CBS4UBU	100
CBS4UR	100
CBS4UY	100
CBS4UBK	100
CBS4UGN	100
EPCBS3U	50
CA701-1M / CA701-1M-S	50 m
CA701-15-1M / CA701-15-1M-S	25 m
CA702 / CA802	50
CA509/K9WHT	100
SCPH2	10
M4	

Type / Cat. No.	Standard Pack
CBS5U	100
CBS5UBU	100
CBS5UR	100
CBS5UY	100
EPCBS3U	50
CA701-1M / CA701-1M-S	50 m
CA701-15-1M / CA701-15-1M-S	25 m
CA702 / CA802	50
CA509/K9WHT	100
SCPH2	10
M5	

Type / Cat. No.	Standard Pack
CSB3/N3U	100
CSB3/N3UBU	100
CSB3/N3UR	100
CSB3/N3UY	100
CSB3/N3UBK	100
CSB3/N3UGN	100
EPCBS3U	50
CA701-1M / CA701-1M-S	50 m
CA701-15-1M / CA701-15-1M-S	25 m
CA702 / CA802	50
CA509/K9WHT	100
SCS1/5.5 Blade size: 1.0 x 5.5 mm	10
SCNT5	10
M3	

Uninsulated	Insulated	I _{max}	Standard Pack
CA512/2-2	CA514/2-2	45 A	100
CA512/2-3	CA514/2-3	45 A	50
CA512/2-4	CA514/2-4	45 A	50
CA512/4-2	CA514/4-2	45 A	100
CA512/4-3	CA514/4-3	45 A	50
CA512/4-4	CA514/4-4	45 A	50
CA772/2		57 A	100
CA772/3		57 A	100
CA772/4		57 A	100
CA772/10		57 A	10
CSTSPC2			10
CSTSPC2-1			10
CSTSPC1-2			10
CSTSPC1-3			10
CSTSPC1-4			10

Uninsulated	Insulated	I _{max}	Standard Pack
CA512/2-2	CA514/2-2	45 A	100
CA512/2-3	CA514/2-3	45 A	50
CA512/2-4	CA514/2-4	45 A	50
CA512/4-2	CA514/4-2	45 A	100
CA512/4-3	CA514/4-3	45 A	50
CA512/4-4	CA514/4-4	45 A	50
CA772/2		60 A	100
CA772/3		60 A	100
CA772/4		60 A	100
CA772/10		60 A	10
CSTSPC2			10
CSTSPC2-1			10
CSTSPC1-2			10
CSTSPC1-3			10
CSTSPC1-4			10

Uninsulated	Insulated	I _{max}	Standard Pack
CA512/15-2	CA514/15-2	35 A	100
CA512/15-3	CA514/15-3	35 A	50
CA512/15-4	CA514/15-4	35 A	50
CA512/17-2	CA514/17-2	35 A	100
CA512/17-3	CA514/17-3	35 A	50
CA512/17-4	CA514/17-4	35 A	50
CA728/2		41 A	50
CA728/3		41 A	50
CA728/4		41 A	50
CA728/10		41 A	10
CSTSPC2			10
CSTSPC2-1			10
CSTSPC1-2			10
CSTSPC1-3			10
CSTSPC1-4			10

CSB3/N3UL

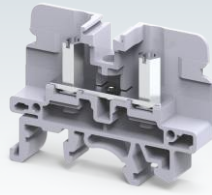

CSB3/N3USH

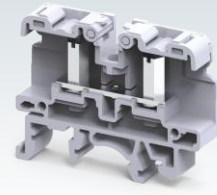

Width (Thickness) x Length	9 x 49 mm				9 x 49 mm			
Height with DIN 35 x 7.5 / 35 x 15 / 32 mm Rail	38 mm / 45.4 mm / 43 mm				38 mm / 45.6 mm / 43.1 mm			
Connection Possibility as per	IEC		UL - CSA		IEC		UL - CSA	
With 1 Conductor per clamp	Stranded / Flexible with Ferrule / Lug		0.5 - 6.0 mm ²		22 - 8 AWG		0.5 - 6.0 mm ²	
With 2 same size Conductors per clamp	Stranded / Flexible with Ferrule / Lug		0.5 - 4.0 mm ²		22 - 10 AWG		0.5 - 4.0 mm ²	
Ratings As Per	IEC60947-7-1	UL-1059	CSA22.2-158	IEC60079-7	IEC60947-7-1	UL-1059	CSA22.2-158	
Voltage	800 V	600 V	600 V	500 V	1000 V	600 V	600 V	
Current	41 A	50 A	50 A	36 A	41 A	50 A	50 A	
Torque	0.5 Nm	4.5 lb-in	4.5 lb-in	0.5 Nm	0.5 Nm	4.5 lb-in	4.5 lb-in	
Approvals								
Insulation Material / Material Group	Polyamide 6,6 / 1				Polyamide 6,6 / 1			
Rated Impulse Voltage / Pollution Degree	8 KV / 3				8 KV / 3			

		Type / Cat. No.	Standard Pack	Type / Cat. No.	Standard Pack
Terminal Block	Grey	CSB3/N3UL	100	CSB3/N3USH	100
	Blue	CSB3/N3ULBU	100		
	Red	CSB3/N3ULR	100		
	Yellow	CSB3/N3ULY	100		
	Black	CSB3/N3ULBK	100		
	Green	CSB3/N3ULGN	100		
End Plate		EPCBS3U	50	EPCBS3U	50
Mounting Rail (Refer Pg. 263 for details)		CA701-1M / CA701-1M-S	50 m	CA701-1M / CA701-1M-S	50 m
		CA701-15-1M / CA701-15-1M-S	25 m	CA701-15-1M / CA701-15-1M-S	25 m
End Clamp (Refer Pg. 264 for details)		CA702 / CA802	50	CA702 / CA802	50
Marking Tags (Refer Pg. 268 for details)		CA509/K9WHT	100	CA509/K9WHT	100
Screw Driver		SCS1/5.5 Blade size: 1.0 x 5.5 mm	10	SCS1/5.5 Blade size: 1.0 x 5.5 mm	10
Nut Driver		SCNT5	10	SCNT5	10
Screw / Stud Size		M3		M3	

Jumpers		Uninsulated	Insulated	I _{max}	Standard Pack	Uninsulated	Insulated	I _{max}	Standard Pack	
Removable Jumpers		2 pole	CA512/15-2	CA514/15-2	35 A	100	CA512/15-2	CA514/15-2	35 A	100
		3 pole	CA512/15-3	CA514/15-3	35 A	50	CA512/15-3	CA514/15-3	35 A	50
		4 pole	CA512/15-4	CA514/15-4	35 A	50	CA512/15-4	CA514/15-4	35 A	50
Permanent Jumpers		2 pole	CA512/17-2	CA514/17-2	35 A	100	CA512/17-2	CA514/17-2	35 A	100
		3 pole	CA512/17-3	CA514/17-3	35 A	50	CA512/17-3	CA514/17-3	35 A	50
		4 pole	CA512/17-4	CA514/17-4	35 A	50	CA512/17-4	CA514/17-4	35 A	50
Screw Type Jumpers		2 pole	CA728/2		41 A	50	CA728/2		41 A	50
		3 pole	CA728/3		41 A	50	CA728/3		41 A	50
		4 pole	CA728/4		41 A	50	CA728/4		41 A	50
		10 pole	CA728/10		41 A	10	CA728/10		41 A	10
Protective Cover		2 Terminal								
		3 Terminal	CSTSPC2			10	CSTSPC2			10
		4 Terminal	CSTSPC2-1			10	CSTSPC2-1			10
Long Protective Cover		100 mm	CSTSPC1-2			10	CSTSPC1-2			10
		200 mm	CSTSPC1-3			10	CSTSPC1-3			10
		300 mm	CSTSPC1-4			10	CSTSPC1-4			10

CSB4/N4UN

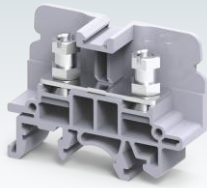

13 x 49 mm

38 mm / 45.5 mm / 42.7 mm

IEC	UL - CSA
1.5 - 10.0 mm ²	16 - 6 AWG
1.5 - 6.0 mm ²	16 - 8 AWG

IEC60947-7-1	UL-1059		
1000 V	600 V		
57 A	65 A		
1.2 Nm	10 lb-in		



Polyamide 6,6 / 1

8 KV / 3

Type / Cat. No.	Standard Pack
CSB4/N4UN	100
CSB4/N4UNBU	100
CSB4/N4UNR	100
CSB4/N4UNY	100

EPCBS3U	50
CA701-1M / CA701-1M-S	50 m
CA701-15-1M / CA701-15-1M-S	25 m
CA702 / CA802	50
CA509/K9WHT	100
SCS1/5.5 Blade size: 1.0 x 5.5 mm	10

M4

CSB4/N4USH

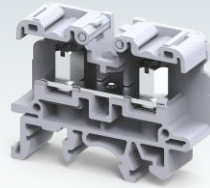

13 x 49 mm

38 mm / 45.5 mm / 42.7 mm

IEC	UL - CSA
1.5 - 10.0 mm ²	16 - 6 AWG
1.5 - 6.0 mm ²	16 - 8 AWG

IEC60947-7-1	UL-1059		
1000 V	600 V		
57 A	65 A		
1.2 Nm	10 lb-in		



Polyamide 6,6 / 1

8 KV / 3

Type / Cat. No.	Standard Pack
CSB4/N4USH	100
CSB4/N4USHBK	100

EPCBS3U	50
CA701-1M / CA701-1M-S	50 m
CA701-15-1M / CA701-15-1M-S	25 m
CA702 / CA802	50
CA509/K9WHT	100
SCS1/5.5 Blade size: 1.0 x 5.5 mm	10

M4

Uninsulated	Insulated	I _{max}	Standard Pack
CA512/2-2	CA514/2-2	45 A	100
CA512/2-3	CA514/2-3	45 A	50
CA512/2-4	CA514/2-4	45 A	50
CA512/4-2	CA514/4-2	45 A	100
CA512/4-3	CA514/4-3	45 A	50
CA512/4-4	CA514/4-4	45 A	50
CA772/2		57 A	100
CA772/3		57 A	100
CA772/4		57 A	100
CA772/10		57 A	10
CSTSPC2			10
CSTSPC2-1			10
CSTSPC1-2			10
CSTSPC1-3			10
CSTSPC1-4			10

CSB5/N5U

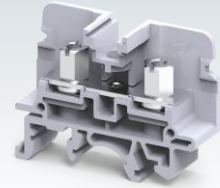

13 x 49 mm

38 mm / 45.5 mm / 42.7 mm

IEC	UL - CSA
1.5 - 16.0 mm ²	16 - 4 AWG
1.5 - 10.0 mm ²	16 - 6 AWG

IEC60947-7-1	UL-1059	CSA22.2-158	IEC60079-7
1000 V	600 V	600 V	630 V
76 A	85 A	85 A	68 A
2.0 Nm	25 lb-in	25 lb-in	2.0 Nm



Polyamide 6,6 / 1

8 KV / 3

Type / Cat. No.	Standard Pack
CSB5/N5U	100
CSB5/N5UBU	100
CSB5/N5UR	100
CSB5/N5UY	100
CSB5/N5UBK	100
CSB5/N5UGN	100

EPCBS3U	50
CA701-1M / CA701-1M-S	50 m
CA701-15-1M / CA701-15-1M-S	25 m
CA702 / CA802	50
CA509/K9WHT	100
SCS1/5.5 Blade size: 1.0 x 5.5 mm	10

M5

Uninsulated	Insulated	I _{max}	Standard Pack
CA512/2-2	CA514/2-2	45 A	100
CA512/2-3	CA514/2-3	45 A	50
CA512/2-4	CA514/2-4	45 A	50
CA512/4-2	CA514/4-2	45 A	100
CA512/4-3	CA514/4-3	45 A	50
CA512/4-4	CA514/4-4	45 A	50
CA772/2		60 A	100
CA772/3		60 A	100
CA772/4		60 A	100
CA772/10		60 A	10
CSTSPC2			10
CSTSPC2-1			10
CSTSPC1-2			10
CSTSPC1-3			10
CSTSPC1-4			10

CSB5/N5USH

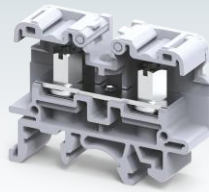

CSTSN4U

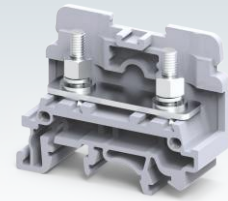

Width (Thickness) x Length	13 x 49 mm		17 x 50 mm		
Height with DIN 35 x 7.5 / 35 x 15 / 32 mm Rail	38 mm / 45.5 mm / 42.7 mm		40.7 mm / 48.0 mm / 45.6 mm		
Connection Possibility as per	IEC	UL - CSA	IEC	UL - CSA	
With 1 Conductor per clamp	Stranded / Flexible with Ferrule / Lug	1.5 - 16.0 mm ²	16 - 4 AWG	1.5 - 10.0 mm ²	22 - 6 AWG
With 2 same size Conductors per clamp	Stranded / Flexible with Ferrule / Lug	1.5 - 10.0 mm ²	16 - 6 AWG	1.5 - 10.0 mm ²	22 - 6 AWG
Ratings As Per	IEC60947-7-1	UL-1059		IEC60947-7-1	UL-1059 CSA22.2-158
Voltage	1000 V	600 V		1000 V	600 V 600 V
Current	76 A	85 A		57 A	65 A 65 A
Torque	2.0 Nm	25 lb-in		1.2 Nm	14 lb-in 14 lb-in
Approvals					
Insulation Material / Material Group	Polyamide 6,6 / 1		Polyamide 6,6 / 1		
Rated Impulse Voltage / Pollution Degree	8 KV / 3		8 KV / 3		

		Type / Cat. No.	Standard Pack	Type / Cat. No.	Standard Pack
Terminal Block	Grey	CSB5/N5USH	100	CSTSN4U	100
	Blue			CSTSN4UBU	100
	Red			CSTSN4UR	100
	Yellow			CSTSN4UY	100
	Black			CSTSN4UBK	100
	Green			CSTSN4UGN	100
End Plate		EPCBS3U	50	EPCSTSU	50
Mounting Rail (Refer Pg. 263 for details)		CA701-1M / CA701-1M-S	50 m	CA701-1M / CA701-1M-S	50 m
		CA701-15-1M / CA701-15-1M-S	25 m	CA701-15-1M / CA701-15-1M-S	25 m
End Clamp (Refer Pg. 264 for details)		CA702 / CA802	50	CA702 / CA802	50
Marking Tags (Refer Pg. 268 for details)		CA509/K9WHT	100	CA509/K2B4WHT	100
Marker Card (Refer Pg. 269 for details)				MC2B4	10
Screw Driver		SCS1/5.5 Blade size: 1.0 x 5.5 mm	10		
Screw / Stud Size		M5		M4	

Jumpers		Uninsulated	Insulated	I _{max}	Standard Pack	Uninsulated	Insulated	I _{max}	Standard Pack	
Removable Jumpers		2 pole	CA512/2-2	CA514/2-2	45 A	100	CA512/1-2	CA514/1-2	45 A	100
		3 pole	CA512/2-3	CA514/2-3	45 A	50	CA512/1-3	CA514/1-3	45 A	50
		4 pole	CA512/2-4	CA514/2-4	45 A	50	CA512/1-4	CA514/1-4	45 A	50
Permanent Jumpers		2 pole	CA512/4-2	CA514/4-2	45 A	100	CA512/3-2	CA514/3-2	45 A	100
		3 pole	CA512/4-3	CA514/4-3	45 A	50	CA512/3-3	CA514/3-3	45 A	50
		4 pole	CA512/4-4	CA514/4-4	45 A	50	CA512/3-4	CA514/3-4	45 A	50
Screw Type Jumpers		2 pole	CA772/2		60 A	100				
		3 pole	CA772/3		60 A	100				
		4 pole	CA772/4		60 A	100				
		10 pole	CA772/10		60 A	10				
Protective Cover		2 Terminal	CSTSPC2			10	CSTSPC1			100
		3 Terminal	CSTSPC2-1			10	CSTSPC1-1			100
		4 Terminal								
Long Protective Cover		100 mm	CSTSPC1-2			10	CSTSPC1-2			10
		200 mm	CSTSPC1-3			10	CSTSPC1-3			10
		300 mm	CSTSPC1-4			10	CSTSPC1-4			10

CSTSN5U

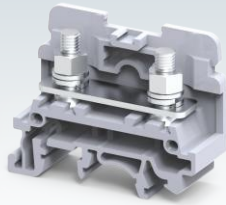

17 x 50 mm
40.7 mm / 48.0 mm / 45.6 mm

IEC **UL - CSA**

1.5 - 16.0 mm² 22 - 4 AWG

1.5 - 16.0 mm² 22 - 4 AWG

IEC60947-7-1	UL-1059	CSA22.2-158
1000 V	600 V	600 V
76 A	80 A	80 A
2.0 Nm	25 lb-in	25 lb-in



Polyamide 6,6 / 1

8 KV / 3

CSTSN5U 100

Type / Cat. No.	Standard Pack
CSTSN5U	100
CSTSN5UBU	100
CSTSN5UR	100
CSTSN5UY	100
CSTSN5UBK	100
CSTSN5UGN	100
EPCSTSU	50
CA701-1M / CA701-1M-S	50 m
CA701-15-1M / CA701-15-1M-S	25 m
CA702 / CA802	50
CA509/K2B4WHT	100
MC2B4	10

M5

Uninsulated	Insulated	I _{max}	Standard Pack
CA512/1-2	CA514/1-2	45 A	100
CA512/1-3	CA514/1-3	45 A	50
CA512/1-4	CA514/1-4	45 A	50
CA512/3-2	CA514/3-2	45 A	100
CA512/3-3	CA514/3-3	45 A	50
CA512/3-4	CA514/3-4	45 A	50

CSTSPC1			100
CSTSPC1-1			100
CSTSPC1-2			10
CSTSPC1-3			10
CSTSPC1-4			10

CSTSN6U

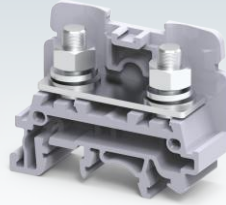

17 x 50 mm
40.7 mm / 48.0 mm / 45.6 mm

IEC **UL - CSA**

1.5 - 35.0 mm² 22 - 2 AWG

1.5 - 35.0 mm² 22 - 2 AWG

IEC60947-7-1	UL-1059	CSA22.2-158
1000 V	600 V	600 V
125 A	125 A	125 A
3.0 Nm	25 lb-in	25 lb-in



Polyamide 6,6 / 1

8 KV / 3

Type / Cat. No.	Standard Pack
CSTSN6U	100
CSTSN6UBU	100
CSTSN6UR	100
CSTSN6UY	100
CSTSN6UBK	100
CSTSN6UGN	100
EPCSTSU	50
CA701-1M / CA701-1M-S	50 m
CA701-15-1M / CA701-15-1M-S	25 m
CA702 / CA802	50
CA509/K2B4WHT	100
MC2B4	10

M6

Uninsulated	Insulated	I _{max}	Standard Pack
CA512/7-2	CA514/7-2	50 A	100
CA512/7-3	CA514/7-3	50 A	50
CA512/7-4	CA514/7-4	50 A	50
CA512/8-2	CA514/8-2	50 A	100
CA512/8-3	CA514/8-3	50 A	50
CA512/8-4	CA514/8-4	50 A	50

CSTSPC1			100
CSTSPC1-1			100
CSTSPC1-2			10
CSTSPC1-3			10
CSTSPC1-4			10

CSTSN6USH

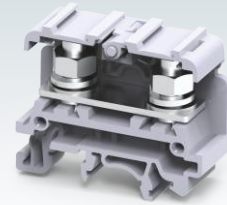

17 x 50 mm
42.2 mm / 49.7 mm / 47.7 mm

IEC **UL - CSA**

1.5 - 35.0 mm² 22 - 2 AWG

1.5 - 35.0 mm² 22 - 2 AWG

IEC60947-7-1	UL-1059	CSA22.2-158
1000 V	600 V	600 V
125 A	125 A	125 A
3.0 Nm	25 lb-in	25 lb-in



Polyamide 6,6 / 1

8 KV / 3

Type / Cat. No.	Standard Pack
CSTSN6USH	100
CSTSN6USHBU	100
CSTSN6USHR	100
CSTSN6USHY	100
CSTSN6USHBK	100
EPCSTSU	50
CA701-1M / CA701-1M-S	50 m
CA701-15-1M / CA701-15-1M-S	25 m
CA702 / CA802	50
CA509/K2B4WHT	100
MC2B4	10

M6

Uninsulated	Insulated	I _{max}	Standard Pack
CA512/7-2	CA514/7-2	50 A	100
CA512/7-3	CA514/7-3	50 A	50
CA512/7-4	CA514/7-4	50 A	50
CA512/8-2	CA514/8-2	50 A	100
CA512/8-3	CA514/8-3	50 A	50
CA512/8-4	CA514/8-4	50 A	50

CSTSPC1			100
CSTSPC1-1			100
CSTSPC1-2			10
CSTSPC1-3			10
CSTSPC1-4			10

CSTSN6UE

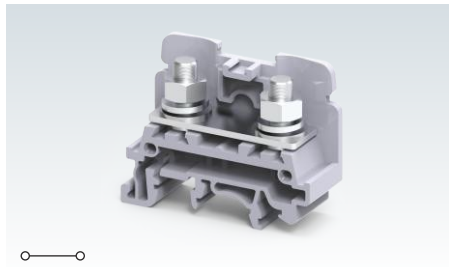

CSN6

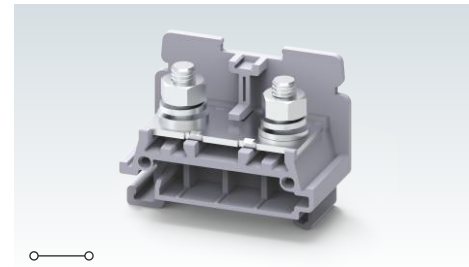

Width (Thickness) x Length	17 x 50 mm				26 x 50 mm					
Height with DIN 35 x 7.5 / 35 x 15 / 32 mm Rail	40.7 mm / 48.0 mm / 46.3 mm				40.7 mm / 48.0 mm / 46.3 mm					
Connection Possibility as per	IEC		UL - CSA		IEC		UL - CSA			
With 1 Conductor per clamp	Stranded / Flexible with Ferrule / Lug		1.5 - 35.0 mm ²		22 - 2 AWG		1.5 - 35.0 mm ²		22 - 2 AWG	
With 2 same size Conductors per clamp	Stranded / Flexible with Ferrule / Lug		1.5 - 35.0 mm ²		22 - 2 AWG		1.5 - 35.0 mm ²		22 - 2 AWG	
Ratings As Per	IEC60947-7-1	UL-1059			IEC60947-7-1	UL-1059				
Voltage	1000 V	600 V			1000 V	600 V				
Current	125 A	125 A			125 A	125 A				
Torque	3.0 Nm	25 lb-in			3.0 Nm	25 lb-in				
Approvals										
Insulation Material / Material Group	Polyamide 6,6 / 1				Polyamide 6,6 / 1					
Rated Impulse Voltage / Pollution Degree	8 KV / 3				8 KV / 3					

		Type / Cat. No.	Standard Pack		Type / Cat. No.	Standard Pack				
Terminal Block	Grey	CSTSN6UE	100		CSN6	50				
End Plate		EPCSTSU	50		EPCSTSU	50				
Mounting Rail	(Refer Pg. 263 for details)	CA701-1M / CA701-1M-S	50 m		CA701-1M / CA701-1M-S	50 m				
		CA701-15-1M / CA701-15-1M-S	25 m			25 m				
End Clamp	(Refer Pg. 264 for details)	CA702 / CA802	50		CA702 / CA802	50				
Marking Tags	(Refer Pg. 268 for details)	CA509/K2B4WHT	100		CA509/K2B4WHT	100				
Marker Card	(Refer Pg. 269 for details)	MC2B4	10		MC2B4	10				
Screw Driver		M6			M6					
Jumpers		Uninsulated	Insulated	Imax	Standard Pack	Uninsulated	Insulated	Imax	Standard Pack	
Removable Jumpers		2 pole	CA512/7-2	CA514/7-2	50 A	100	CA512/11-2	CA514/11-2	125 A	50
		3 pole	CA512/7-3	CA514/7-3	50 A	50				
		4 pole	CA512/7-4	CA514/7-4	50 A	50				
Permanent Jumpers		2 pole	CA512/8-2	CA514/8-2	50 A	100	CA512/12-2	CA514/12-2	125 A	50
		3 pole	CA512/8-3	CA514/8-3	50 A	50				
		4 pole	CA512/8-4	CA514/8-4	50 A	50				
Screw Type Jumpers		2 pole								
		3 pole								
		4 pole								
		10 pole								
Protective Cover		2 Terminal	CSTSPC1			100				
		3 Terminal	CSTSPC1-1			100				
		4 Terminal								
Long Protective Cover		100 mm	CSTSPC1-2			10				
		200 mm	CSTSPC1-3			10				
		300 mm	CSTSPC1-4			10				

CSE5U

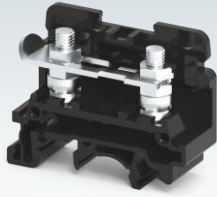

17 x 50 mm

40.7 mm / 48.0 mm / 45.6 mm

IEC UL - CSA

1.5 - 16.0 mm² 22 - 4 AWG

1.5 - 16.0 mm² 22 - 4 AWG

IEC60947-7-1

800 V

76 A

2.0 Nm



Polyamide 6,6 / 1

Type / Cat. No.	Standard Pack
CSE5U*	100
EPCSTSU	50
CA701-1M / CA701-1M-S	50 m
CA701-15-1M / CA701-15-1M-S	25 m
CA702 / CA802	50
CA509/K2B4WHT	100
MC2B4	10

M5

Uninsulated	Insulated	I _{max}	Standard Pack
CA512/1-2	CA514/1-2	45 A	100
CA512/1-3	CA514/1-3	45 A	50
CA512/1-4	CA514/1-4	45 A	50
CA512/3-2	CA514/3-2	45 A	100
CA512/3-3	CA514/3-3	45 A	50
CA512/3-4	CA514/3-4	45 A	50

* CSE5U Terminal Block is used for earth link disconnection application.

DISCONNECT & TEST TERMINAL BLOCKS

CBDT4U Disconnect & Test Terminal Block is used for measuring, control and regulatory circuits.

Disconnection is achieved by means of a slide link operated with a Screw Driver.

CBDT4U terminals have a barrel nut configuration which can be operated with a screw driver.

Adjacent terminal can be shorted with the aid of removable and permanent jumpers. Also pre assembled internal screw type jumpers can be used for shorting. Temporary shorting can be achieved using SWCBDT switchable jumpers.

CBDT4U

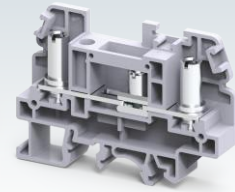

Width (Thickness) x Length	13 x 71 mm		
Height with DIN 35 x 7.5 / 35 x 15 / 32 mm Rail	50.2 mm / 57.7 mm / 54.8 mm		
Connection Possibility as per	IEC UL - CSA		
With 1 Conductor per clamp	Stranded / Flexible with Ferrule / Lug	1.5 - 6.0 mm ² 16 - 8 AWG	
	Solid with Ferrule / Lug	1.5 - 6.0 mm ²	
With 2 same size Conductors per clamp	Stranded / Flexible with Ferrule / Lug	1.5 - 6.0 mm ² 16 - 8 AWG	
Ratings As Per	IEC60947-7-1	UL-1059	CSA22.2-158
Voltage	1000 V	600 V	600 V
Current	41 A	45 A	45 A
Torque	1.2 Nm	14 lb-in	14 lb-in
Approvals			
Insulation Material / Material Group	Polyamide 6,6 / 1		
Rated Impulse Voltage / Pollution Degree	8 KV / 3		

		Type / Cat. No.	Standard Pack
Terminal Block	Grey	CBDT4U	50
	Blue	CBDT4UBU	50
	Red	CBDT4UR	50
	Yellow	CBDT4UY	50
	Black	CBDT4UBK	50
	Green	CBDT4UGN	50
End Plate		EPCBDT4U	50
Mounting Rail (Refer Pg. 263 for details)		CA701-1M / CA701-1M-S	50 m
		CA701-15-1M / CA701-15-1M-S	25 m
End Clamp (Refer Pg. 264 for details)		CA502 / CA702	50
Marking Tags (Refer Pg. 268 for details)		CA509/K2B4WHT	100
Marker Card (Refer Pg. 269 for details)		MC2B4	10
Screw Driver		SCS1/5.5 Blade size: 1.0 x 5.5 mm	10
Screw / Stud Size		M4	

Jumpers		Uninsulated	Insulated	I _{max}	Standard Pack		
Removable Jumpers		2 pole	CA512/2-2	CA514/2-2	41 A	100	
		3 pole	CA512/2-3	CA514/2-3	41 A	50	
		4 pole	CA512/2-4	CA514/2-4	41 A	50	
Permanent Jumpers		2 pole	CA512/4-2	CA514/4-2	41 A	100	
		3 pole	CA512/4-3	CA514/4-3	41 A	50	
		4 pole	CA512/4-4	CA514/4-4	41 A	50	
Screw Type Jumpers		2 pole	CA775/2		25 A	100	
		3 pole	CA775/3		25 A	50	
		4 pole	CA775/4		25 A	50	
		10 pole	CA775/10		25 A	10	
Protective Cover		2 Terminal	CDTPC1			100	
		3 Terminal	CDTPC2			100	
		4 Terminal					
		100 mm	CDTPC3				10
		200 mm	CDTPC4				10
300 mm	CDTPC5				10		
Switchable Link Assembly		SWCBDT		41 A	50		

CBDT4UNS

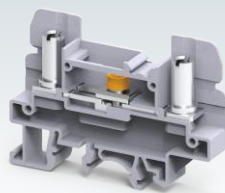

Width (Thickness) x Length	11 x 67.2 mm		
Height with DIN 35 x 7.5 / 35 x 15 / 32 mm Rail	48.2 mm / 55.7 / 52.8 mm		
Connection Possibility as per	IEC	UL - CSA	
With 1 Conductor per clamp	Stranded / Flexible with Ferrule / Lug	1.5 - 6.0 mm ²	16 - 8 AWG
	Solid with Ferrule / Lug	1.5 - 6.0 mm ²	
With 2 same size Conductors per clamp	Stranded / Flexible with Ferrule / Lug	1.5 - 6.0 mm ²	16 - 8 AWG
Ratings As Per	IEC60947-7-1	UL-1059	
Voltage	1000 V	600 V	
Current	41 A	45 A	
Torque	1.2 Nm	14 lb-in	
Approvals			
Insulation Material / Material Group	Polyamide 6,6 / 1		
Rated Impulse Voltage / Pollution Degree	8 KV / 3		

		Type / Cat. No.	Standard Pack
Terminal Block	With Copper Alloy Studs	CBDT4UNS	50
	With High Torque Steel Studs	CBDT4UNSE	50
End Plate		EPCBDT4UN	50
Mounting Rail (Refer Pg. 263 for details)		CA701-1M / CA701-1M-S	50 m
		CA701-15-1M / CA701-15-1M-S	25 m
End Clamp (Refer Pg. 264 for details)		CA502 / CA702	50
Marking Tags (Refer Pg. 268 for details)		CA509/K10WHT	100
Marker Card (Refer Pg. 269 for details)		MC10	10
Screw Driver		SCS1/5.5 Blade size: 1.0 x 5.5 mm	10
Screw / Stud Size		M4	

Jumpers		Uninsulated	Insulated	I _{max}	Standard Pack	
Removable Jumpers		2 pole	CA512/13-2	CA514/13-2	35 A	100
		3 pole	CA512/13-3	CA514/13-3	35 A	50
		4 pole	CA512/13-4	CA514/13-4	35 A	50
Permanent Jumpers		2 pole	CA512/14-2	CA514/14-2	35 A	100
		3 pole	CA512/14-3	CA514/14-3	35 A	50
		4 pole	CA512/14-4	CA514/14-4	35 A	50
		10 pole		CA514/14-10	35 A	50
Protective Cover		2 Terminal				
		3 Terminal				
		4 Terminal				
Long Protective Cover		100 mm	CBDTPC3			10
		200 mm	CBDTPC4			10
		300 mm	CBDTPC5			10
Shorting Plug		2 pole	QJ11/2			25
		4 pole	QJ11/4			25

DISCONNECT & TEST TERMINAL BLOCKS

STH4DT Disconnect & Test Terminal Block is used for measuring, control and regulatory circuits. They provide a clear functional advantage for devices having utility instruments and associated transformers.

Separate testing points facilitate insertion of test probes. Disconnection is achieved by means of a slide link operated with a Screw Driver.

STH4DTSH Terminal Block has 2 STH4DT Terminal Blocks shorted to achieve switchable cross connection for current transformers (on one side).

STH4DTFT is a feed through terminal with the same profile of the STH4DT Terminal Block.

In all of the above Terminal Blocks, two Lugs can be connected to the Terminal, without sacrificing the safety of the Terminal Block.

Width (Thickness) x Length		11 x 86 mm
Height with DIN 35 x 7.5 / 35 x 15 / 32 mm Rail		51.5 mm / 59.0 mm / 56.4 mm
Connection Possibility as per		
With 1 Conductor per clamp	Stranded / Flexible with Ferrule / Lug Solid with Ferrule / Lug	
With 2 same size Conductors per clamp	Stranded / Flexible with Ferrule / Lug	
Ratings As Per		
Voltage		1000 V 600 V 600 V
Current		41 A 35 A 35 A
Torque		1.2 Nm 14 lb-in 14 lb-in
Approvals		
Insulation Material / Material Group		Polyamide 6,6 / 1
Rated Impulse Voltage / Pollution Degree		8 KV / 3

STH4DT

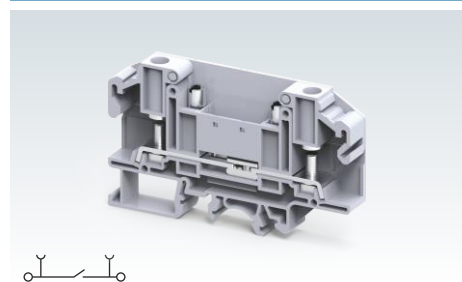

IEC		UL - CSA	
1.5 - 6.0 mm ²		22 - 8 AWG	
1.5 - 6.0 mm ²		22 - 8 AWG	
IEC60947-7-1	UL-1059	CSA22.2-158	
1000 V	600 V	600 V	
41 A	35 A	35 A	
1.2 Nm	14 lb-in	14 lb-in	
Polyamide 6,6 / 1			
8 KV / 3			

Terminal Block	Grey Blue Red Yellow Black Green With Standard Screw With Test Socket Tapped With Socket Headed Screw
End Plate	
Mounting Rail (Refer Pg. 263 for details)	
End Clamp (Refer Pg. 264 for details)	
Marking Tags (Refer Pg. 268 for details)	
Marker Card (Refer Pg. 269 for details)	
Screw Driver	
Screw / Stud Size	

Type / Cat. No.	Standard Pack
STH4DT	50
STH4DTBU	50
STH4DTR	50
STH4DTY	50
STH4DTBK	50
STH4DTGN	50
STH4DT/S	50
STH4DTTP	50
EPSTH4DT	50
CA701-1M / CA701-1M-S	50 m
CA701-15-1M / CA701-15-1M-S	25 m
CA702 / CA802	50
CA509/K10WHT	100
MC10	10
SCS1.0/5.5 Blade size: 1.0 x 5.5 mm	10
M4	

Jumpers		
Removable Jumpers		2 pole
		3 pole
		4 pole
Permanent Jumpers		2 pole
		3 pole
		4 pole
		10 pole
Alternate Permanent Jumpers		3 pole
		4 pole
Shorting Plug		2 pole
		4 pole
Sliding Jumper		
Lock Out Cap		

Uninsulated	Insulated	I _{max}	Standard Pack
CA512/13-2	CA514/13-2	35 A	100
CA512/13-3	CA514/13-3	35 A	50
CA512/13-4	CA514/13-4	35 A	50
CA512/14-2	CA514/14-2	35 A	100
CA512/14-3	CA514/14-3	35 A	50
CA512/14-4	CA514/14-4	35 A	50
	CA514/14-10	35 A	50
CA514/14-3A		35 A	10
CA514/14-4A		35 A	10
QJ11/2			25
QJ11/4			25
STLS2			50
STLS3			25
STLS4			25
LCSTH4DT			50

STH4DTSH

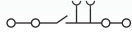
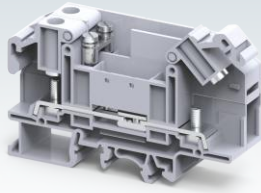

22 x 86 mm

52.2 mm / 59.0 mm / 56.4 mm

IEC	UL - CSA
1.5 - 6.0 mm ²	22 - 8 AWG

1.5 - 6.0 mm² 22 - 8 AWG

IEC60947-7-1	UL-1059	CSA22.2-158
1000 V	300 V	300 V
34 A	25 A	25 A
1.2 Nm	14 lb-in	14 lb-in



Polyamide 6,6 / 1

8 KV / 3

Type / Cat. No.	Standard Pack
STH4DTSH	24

EPSTH4DT	50
CA701-1M / CA701-1M-S	50 m
CA701-15-1M / CA701-15-1M-S	25 m
CA702 / CA802	50
CA509/K10WHT	100
MC10	10
SCS1.0/5.5 Blade size: 1.0 x 5.5 mm	10
M4	

Uninsulated	Insulated	I _{max}	Standard Pack
CA512/13-2	CA514/13-2	34 A	100
CA512/13-3	CA514/13-3	34 A	50
CA512/13-4	CA514/13-4	34 A	50
CA512/14-2	CA514/14-2	35 A	100
CA512/14-3	CA514/14-3	35 A	50
CA512/14-4	CA514/14-4	35 A	50
	CA514/14-10	35 A	50
CA514/14-3A		34 A	10
CA514/14-4A		34 A	10
QJ11/2			25
QJ11/4			25

LCSTH4DT	50
----------	----

STH4DTFT

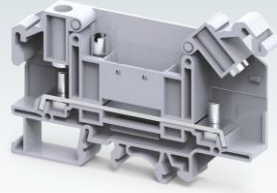

11 x 86 mm

52.2 mm / 59.0 mm / 56.4 mm

IEC	UL - CSA
1.5 - 6.0 mm ²	22 - 8 AWG

1.5 - 6.0 mm² 22 - 8 AWG

IEC60947-7-1	UL-1059	CSA22.2-158
1000 V	600 V	300 V
41 A	50 A	50 A
1.2 Nm	14 lb-in	14 lb-in



Polyamide 6,6 / 1

8 KV / 3

Type / Cat. No.	Standard Pack
STH4DTFT	50
STH4DTFTBU	50

EPSTH4DT	50
CA701-1M / CA701-1M-S	50 m
CA701-15-1M / CA701-15-1M-S	25 m
CA702 / CA802	50
CA509/K10WHT	100
MC10	10
SCS1.0/5.5 Blade size: 1.0 x 5.5 mm	10
M4	

Uninsulated	Insulated	I _{max}	Standard Pack
CA512/13-2	CA514/13-2	35 A	100
CA512/13-3	CA514/13-3	35 A	50
CA512/13-4	CA514/13-4	35 A	50
CA512/14-2	CA514/14-2	35 A	100
CA512/14-3	CA514/14-3	35 A	50
CA512/14-4	CA514/14-4	35 A	50
	CA514/14-10	35 A	50
CA514/14-3A		35 A	10
CA514/14-4A		35 A	10
QJ11/2			25
QJ11/4			25

LCSTH4DT	50
----------	----

Usage of STH4DT Test Disconnect Terminal Block for metering CT for 3 wire system

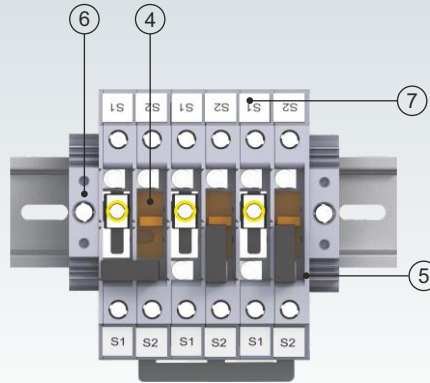
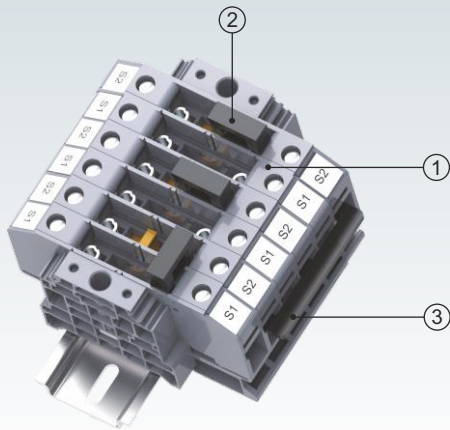

No.	Cat. No.	Qty.
1	STH4DT	6
2	QJ11/2	3
3	CA514/14-3A	1
4	LCSTH4DT	3
5	EPSTH4DT	1
6	CA202	2
7	CA509/K10	12

Operating Status

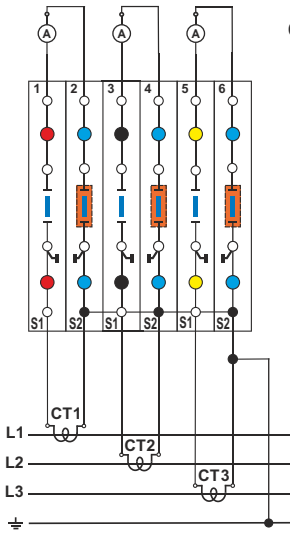

Measurement Standard for Phase L1

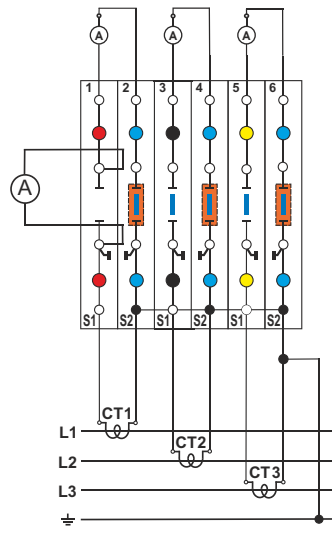

Sequence for test :

- 1) Connect a Ammeter to test sockets of terminal 1
- 2) Open disconnect slide link of terminal 1
- 3) Take the measurement

Measurement with External Current Source

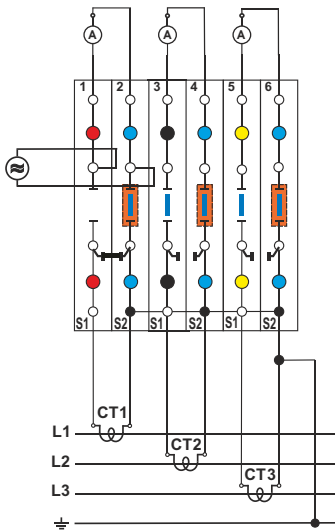

Sequence for test :

- 1) Close the terminals 1 & 2 with shorting plug QJ11/2
- 2) Open disconnect slide link of terminal 1
- 3) Connect the external source to the test sockets of the terminals 1 & 2.
- 4) Take the measurement

Replacement Meter for Phase L1

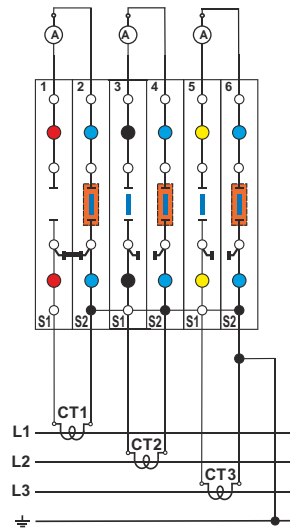

Sequence for test :

- 1) Close the terminals 1 & 2 with shorting plug QJ11/2
- 2) Open disconnect slide link of terminal 1
- 3) Disconnect the meter from phase R of the terminals 1 & 2.
- 4) Replace the meter

Usage of STH4DT Test Disconnect Terminal Block for metering CT for 4 wire system

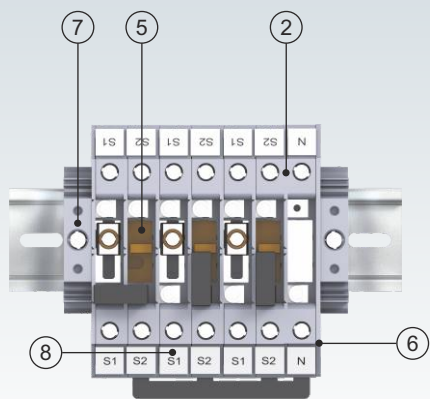
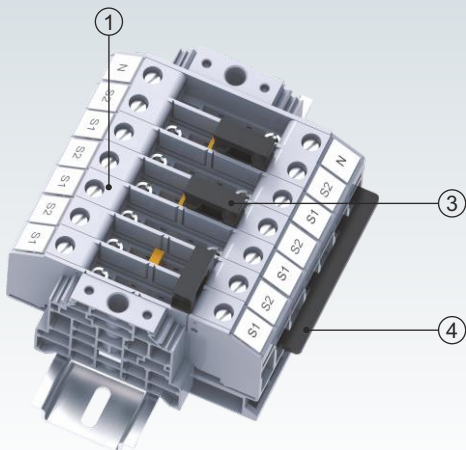

No.	Cat. No.	Qty.
1	STH4DT	6
2	STH4DTFT	1
3	QJ11/2	3
4	CA514/14-4A	1
5	LCSTH4DT	3
6	EPSTH4DT	1
7	CA202	2
8	CA509/K10	14

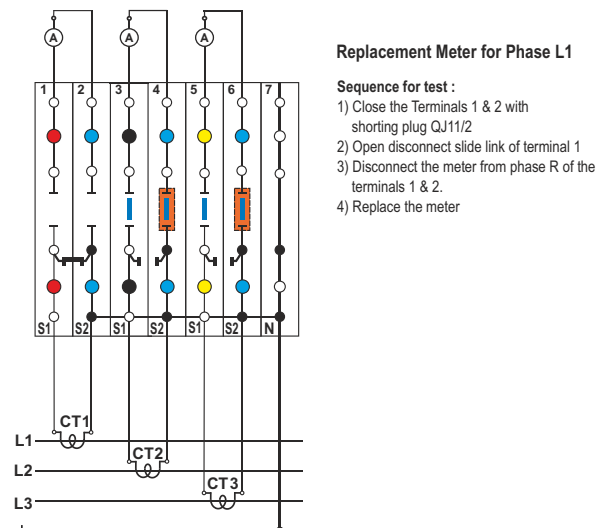
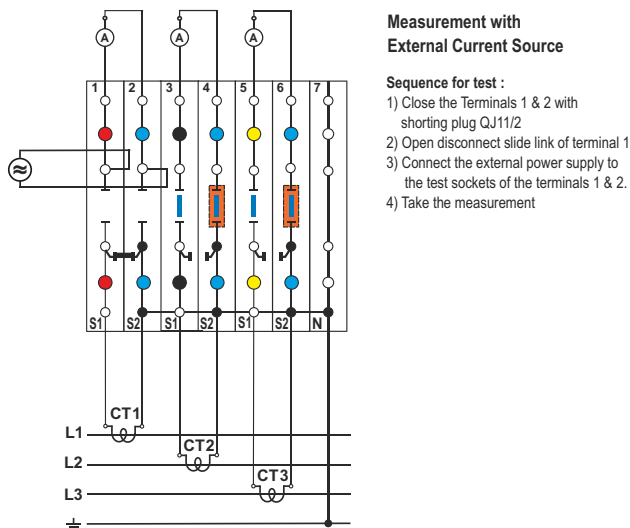
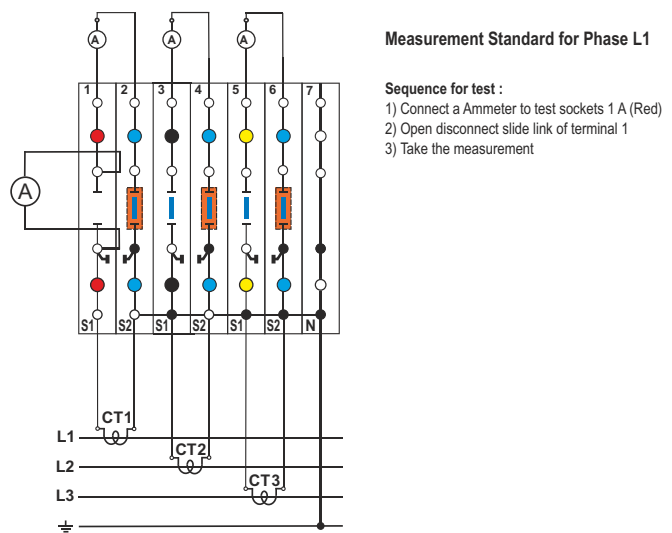
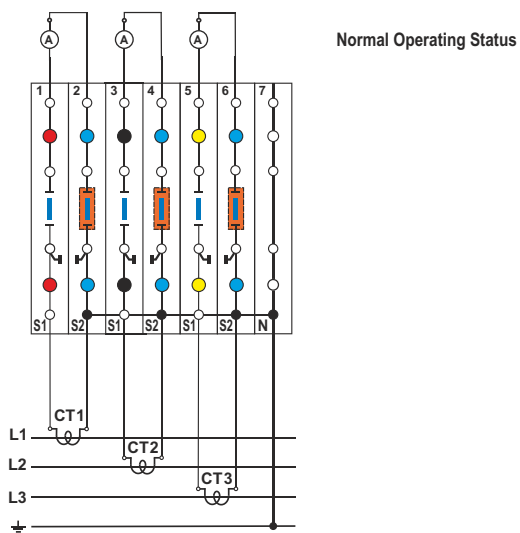

Usage of STH4DT Test Disconnect Terminal Block for multi function meter for 3 wire system

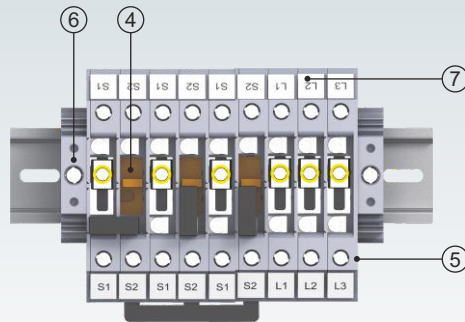
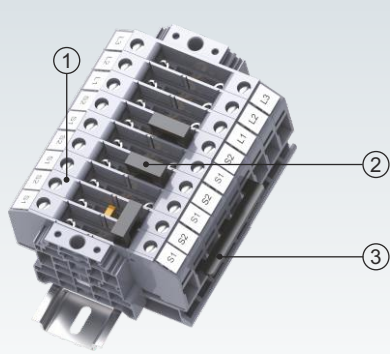

No.	Cat. No.	Qty.
1	STH4DT	9
2	QJ11/2	3
3	CA514/14-3A	1
4	LCSTH4DT	3
5	EPSTH4DT	1
6	CA202	2
7	CA509/K10	18

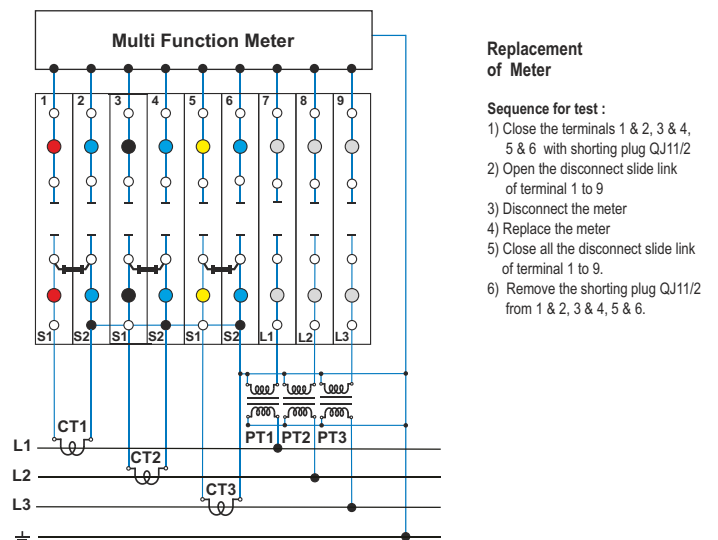
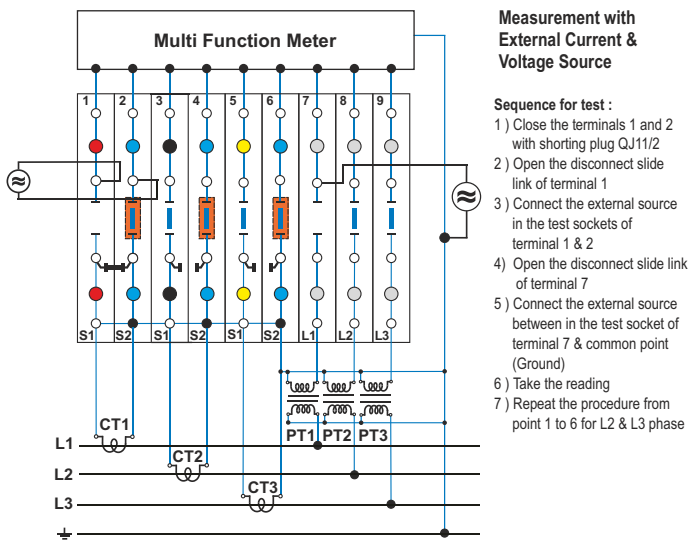
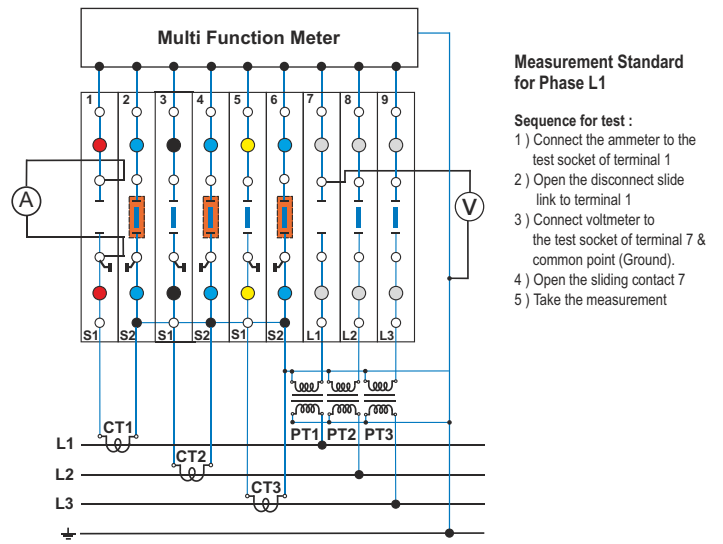
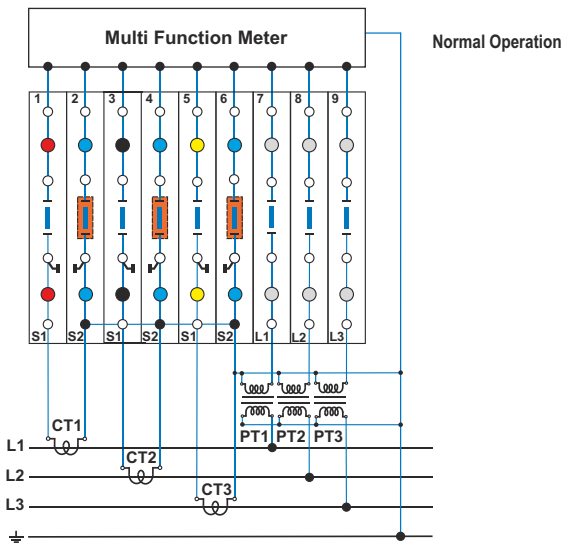

Usage of STH4DT Test Disconnect Terminal Block for multi function meter for 4 wire system

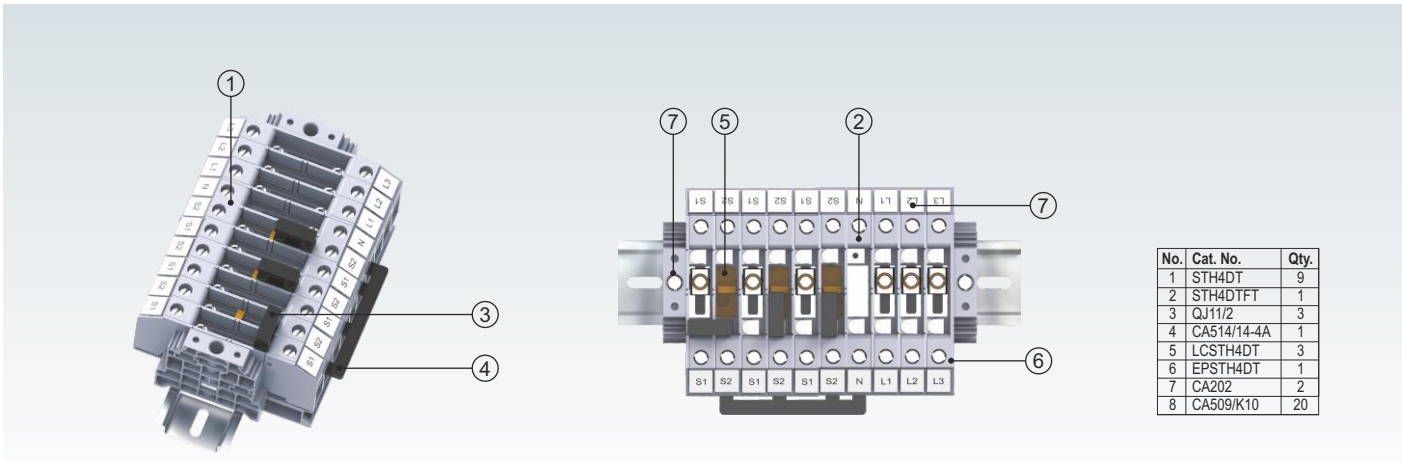

No.	Cat. No.	Qty.
1	STH4DT	9
2	STH4DTFT	1
3	QJ11/2	3
4	CA514/14-4A	1
5	LCSTH4DT	3
6	EPSTH4DT	1
7	CA202	2
8	CA509/K10	20

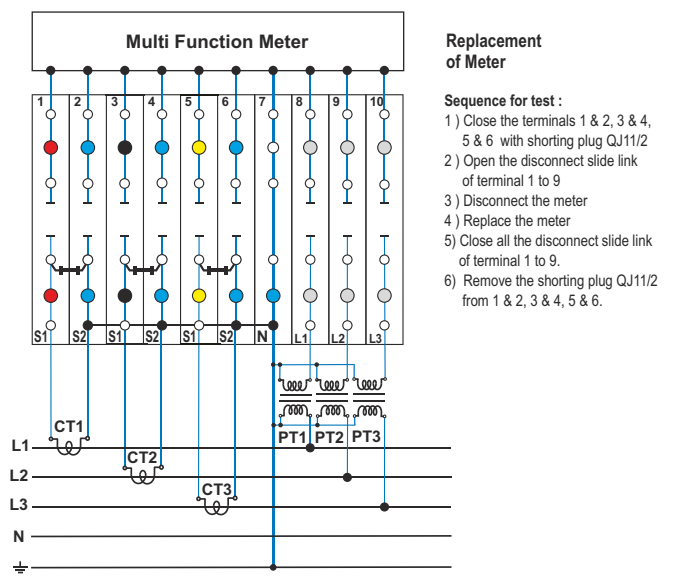
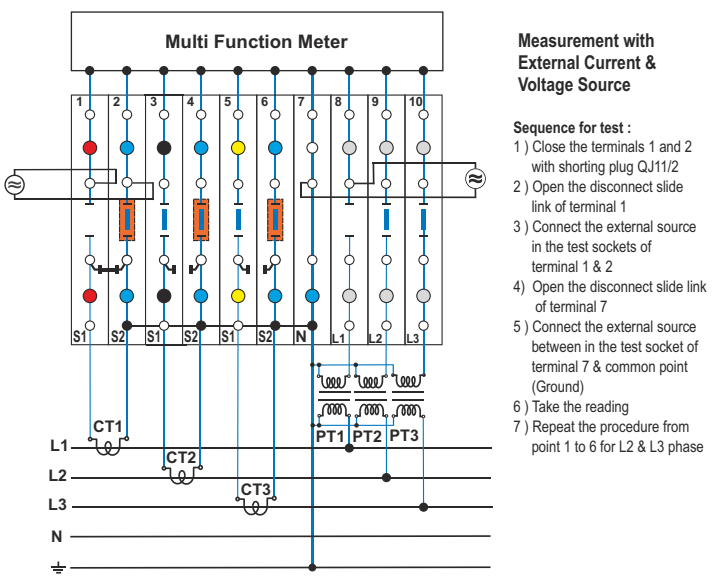
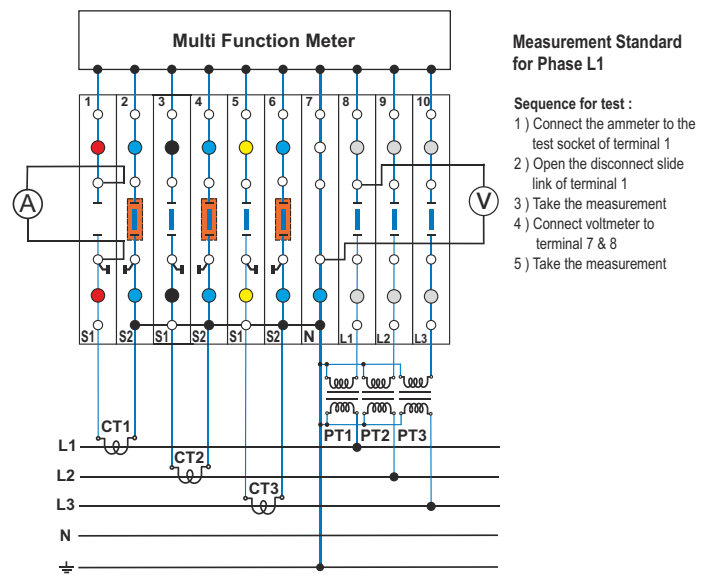
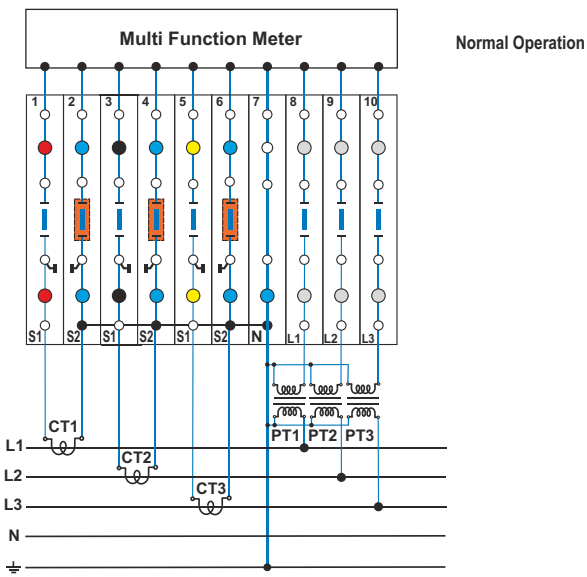

POWER TERMINAL BLOCKS

CBB series Terminal Blocks are preferred for application using wires of large cross section. The Wire is crimped to a ring / fork lug and is screwed on to the flat current bar of the Terminal Block. Specially designed Mounting Feet holds the Terminal Block rigidly on to the Mounting Rail.

Two Lugs of the rated cross section can be connected to the Terminal Block, without sacrificing the safety of the Terminal Block.

PPCBB series partition plates can be installed even after assembly of cables on the Terminal Blocks.



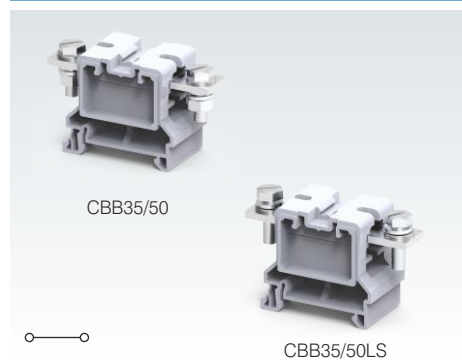

Terminals with suffix LS have a standard slotted bolt assembled in the threaded bus bar. This enables faster wiring without the need of two wrenches / spanners.

Width (Thickness) x Length		32 x 75 mm
Height with DIN 35 x 7.5 / 35 x 15 mm Rail		47.3 mm / 54.5 mm
Connection Possibility as per		
With 1 Conductor per clamp	Stranded / Flexible with Ferrule / Lug	
With 2 same size Conductors per clamp	Stranded / Flexible with Ferrule / Lug	
Ratings As Per		
Voltage		1000 V 600 V 600 V
Current		150 A 150 A 150 A
Torque		3.0 Nm 27 lb-in 27 lb-in
Approvals		
Insulation Material / Material Group		Polyamide 6,6 / 1
Rated Impulse Voltage / Pollution Degree		8 KV / 3

CBB35/50 & CBB35/50LS



IEC		UL - CSA	
6 - 50.0 mm ²		10 - 1/0 AWG	
6 - 50.0 mm ²		10 - 1/0 AWG	
IEC60947-1	UL-1059	CSA22.2-158	
1000 V	600 V	600 V	
150 A	150 A	150 A	
3.0 Nm	27 lb-in	27 lb-in	
			
Polyamide 6,6 / 1			
8 KV / 3			

Terminal Block	With Nut & Bolt configuration With Threaded Current Bar	
Partition Plate		
Mounting Rail	(Refer Pg. 263 for details)	
End Clamp	(Refer Pg. 264 for details)	
Marking Tags	(Refer Pg. 268 for details)	
Marker Card	(Refer Pg. 269 for details)	
Screw / Bolt Size		M6
Jumpers		
		70 mm
		80 mm
Protective Cover for installing on PPCBB & PPCBB1		100 mm
		130 mm
		160 mm
		200 mm
		250 mm
Permanent Jumpers		2 pole
		3 pole

Type / Cat. No.	Standard Pack	
CBB35/50	10	
CBB35/50LS	10	
PPCBB	10	
CA701-1M / CA701-1M-S	50 m	
CA701-15-1M / CA701-15-1M-S	25 m	
CA702 / CA802 / CA202	50	
CA509/K10WHT	100	
MC10	10	
Screw / Bolt Size		
M6		
Uninsulated	Imax	Standard Pack
CBBPC1/70		10
CBBPC1/80		10
CTSPC2-1		10
CBBPC1/130		10
CBBPC1/160		10
CBBPC1/200		10
CBBPC1/250		10
CA790/2	150 A	10
CA790/3	150 A	10

Installation instruction:

It is recommended to provide a back support to the wire while tightening the clamping bolt to avoid deformation of the mounting rail or to prevent damage of the Terminal Block by torsional force.

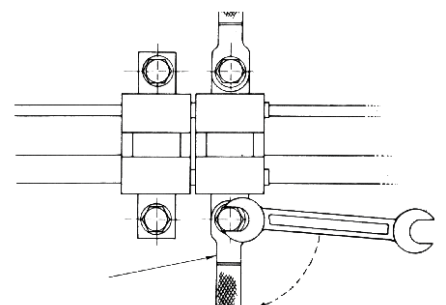

CBB70 & CBB70LS

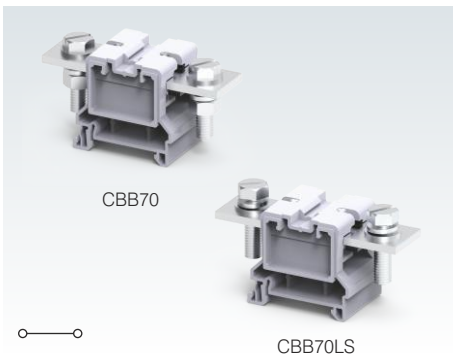

38 x 92 mm		
47.3 mm / 54.5 mm		
IEC	UL - CSA	
6 - 70.0 mm ²	8 - 2/0 AWG	
6 - 70.0 mm ²	8 - 2/0 AWG	
IEC60947-7-1	UL-1059	CSA22.2-158
1000 V	600 V	600 V
192 A	175 A	175 A
6.0 Nm	54 lb-in	54 lb-in
Polyamide 6,6 / 1		
8 KV / 3		

Type / Cat. No.	Standard Pack
CBB70	10
CBB70LS	10
PPCBB	10
CA701-1M / CA701-1M-S	50 m
CA701-15-1M / CA701-15-1M-S	25 m
CA702 / CA802 / CA202	50
CA509/K16WHT	100
MC16	10
M8	

Uninsulated	Imax	Standard Pack
CBBPC1/70		10
CBBPC1/80		10
CTSPC2-1		10
CBBPC1/130		10
CBBPC1/160		10
CBBPC1/200		10
CBBPC1/250		10
CA791/2	192 A	10
CA791/3	192 A	10

CBB95 & CBB95LS

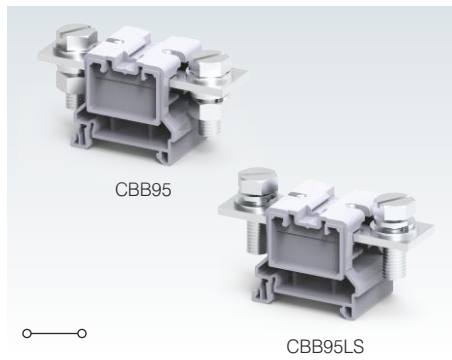

38 x 92 mm		
47.3 mm / 54.5 mm		
IEC	UL - CSA	
16 - 95.0 mm ²	8 - 4/0 AWG	
16 - 95.0 mm ²	8 - 4/0 AWG	
IEC60947-7-1	UL-1059	CSA22.2-158
1000 V	600 V	600 V
232 A	230 A	230 A
10.0 Nm	90 lb-in	90 lb-in
Polyamide 6,6 / 1		
8 KV / 3		

Type / Cat. No.	Standard Pack
CBB95	10
CBB95LS	10
PPCBB1	10
CA701-1M / CA701-1M-S	50 m
CA701-15-1M / CA701-15-1M-S	25 m
CA702 / CA802 / CA202	50
CA509/K16WHT	100
MC16	10
M8	

Uninsulated	Imax	Standard Pack
CBBPC2/100		10
CBBPC2/160		10
CBBPC2/200		10
CBBPC2/250		10
CA791/2	232 A	10
CA791/3	232 A	10

CBB120 & CBB120LS

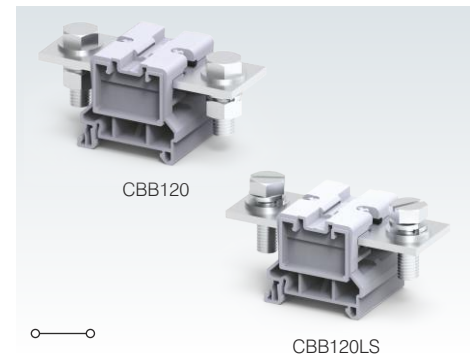

48 x 100 mm		
47.3 mm / 54.5 mm		
IEC	UL - CSA	
16 - 120.0 mm ²	8 - 250 KCMIL	
16 - 120.0 mm ²	8 - 250 KCMIL	
IEC60947-7-1	UL-1059	CSA22.2-158
1000 V	600 V	600 V
269 A	255 A	255 A
10.0 Nm	90 lb-in	90 lb-in
Polyamide 6,6 / 1		
8 KV / 3		

Type / Cat. No.	Standard Pack
CBB120	10
CBB120LS	10
PPCBB1	10
CA701-1M / CA701-1M-S	50 m
CA701-15-1M / CA701-15-1M-S	25 m
CA702 / CA802 / CA202	50
CA509/K16WHT	100
MC16	10
M10	

Uninsulated	Imax	Standard Pack
CBBPC2/100		10
CBBPC2/160		10
CBBPC2/200		10
CBBPC2/250		10
CA793/2	269 A	10
CA793/3	269 A	10

POWER TERMINAL BLOCKS

In PTB35/50SH, PTB70/95SH Terminal Blocks a hinged protective cover makes the Terminal Block shock proof (finger safe) and has marker recess to accept marking tag.

The Terminal Blocks can be stacked together by pressing the adjacent Terminal Blocks firmly.

Adjacent terminals can be shorted by removing a thin wall partition and using 2 & 3 pole shorting system.

Optional Marker Holder MHPTB35/50 can be used for installing marking tags on the Terminal Blocks without protective covers.

Width (Thickness) x Length		48 x 110 mm
Height with DIN 35 x 7.5 / 35 x 15 mm Rail		47.3 mm / 54.5 mm
With Integral Shroud		
Connection Possibility as per		
With 1 Conductor per clamp	Stranded / Flexible with Ferrule / Lug	
With 2 same size Conductors per clamp	Stranded / Flexible with Ferrule / Lug	
Ratings As Per		
Voltage	1000 V	600 V
Current	309 A	285 A
Torque	14.0 Nm	127 lb-in
Approvals		
Insulation Material / Material Group		
Rated Impulse Voltage / Pollution Degree		

CBB150 & CBB150LS

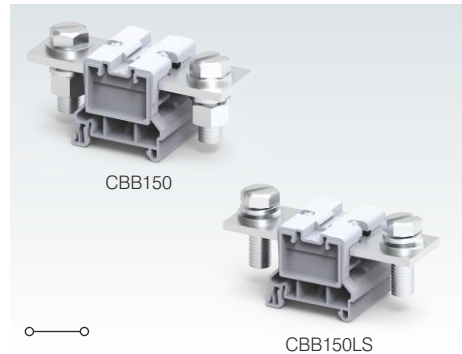

IEC		UL - CSA	
16 - 150.0 mm ²		8 - 300 KCMIL	
16 - 150.0 mm ²		8 - 300 KCMIL	
IEC60947-7-1	UL-1059	CSA22.2-158	
1000 V	600 V	600 V	
309 A	285 A	285 A	
14.0 Nm	127 lb-in	127 lb-in	
Polyamide 6,6 / 1			
8 KV / 3			

Terminal Block	With Nut & Bolt configuration With Threaded Current Bar With Integral Shroud
Partition Plate / Protective Shroud	PPCBB1
Mounting Rail (Refer Pg. 263 for details)	
End Clamp (Refer Pg. 264 for details)	
Marking Tags (Refer Pg. 268 for details)	
Marker Card (Refer Pg. 269 for details)	MC16
Marker Holder	
Screw / Bolt Size	M12

Type / Cat. No.	Standard Pack
CBB150	10
CBB150LS	10
PPCBB1	10
CA701-1M / CA701-1M-S	50 m
CA701-15-1M / CA701-15-1M-S	25 m
CA702 / CA802 / CA202	50
CA509/K16WHT	100
MC16	10
M12	

Jumpers		
Protective Cover for installing on PPCBB & PPCBB1		100 mm
		160 mm
		200 mm
		250 mm
Permanent Jumpers		2 pole
		3 pole

Uninsulated	I _{max}	Standard Pack
CBBPC2/100		10
CBBPC2/160		10
CBBPC2/200		10
CBBPC2/250		10
CA794/2	309 A	10
CA794/3	309 A	10

Installation instruction:

It is recommended to provide a back support to the wire while tightening the clamping bolt to avoid deformation of the mounting rail or to prevent damage of the Terminal Block by torsional force.

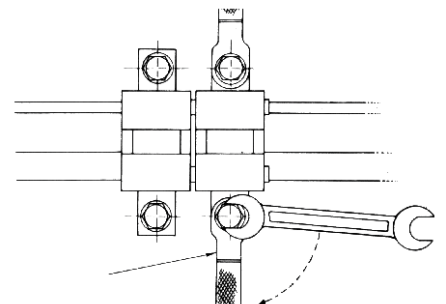

CBB185 & CBB185LS

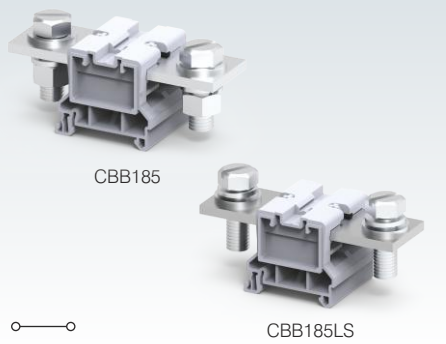

48 x 110 mm
47.3 mm / 54.5 mm

IEC	UL - CSA
16 - 185.0 mm ²	8 - 350 KCMIL
16 - 185.0 mm ²	8 - 350 KCMIL

IEC60947-7-1	UL-1059	CSA22.2-158	
1000 V	600 V	600 V	
353 A	310 A	310 A	
14.0 Nm	127 lb-in	127 lb-in	
Polyamide 6,6 / 1			
8 KV / 3			

Type / Cat. No.	Standard Pack
CBB185	10
CBB185LS	10
PPCBB1	10
CA701-1M / CA701-1M-S	50 m
CA701-15-1M / CA701-15-1M-S	25 m
CA702 / CA802 / CA202	50
CA509/K16WHT	100
MC16	10
M12	

Uninsulated	Imax	Standard Pack
CBBPC2/100		10
CBBPC2/160		10
CBBPC2/200		10
CBBPC2/250		10
CA794/2	353 A	10
CA794/3	353 A	10

PTB35/50 & PTB35/50SH

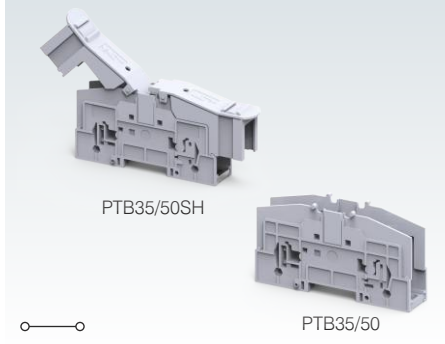

25 x 113 mm / 169 mm (with Shroud)
61.0 mm / 68.3 mm
66.5 mm / 73.6 mm

IEC	UL - CSA
1.5 - 50.0 mm ²	8 - 2 AWG
1.5 - 50.0 mm ²	8 - 2 AWG

IEC60947-7-1	UL-1059	CSA22.2-158	IEC60079-7
1000 V	600 V	600 V	1100 V
150 A	115 A	115 A	126 A
3.0 Nm	27 lb-in	27 lb-in	3.0 Nm
Polyamide 6,6 / 1			
8 KV / 3			

Type / Cat. No.	Standard Pack
PTB35/50	10
PTB35/50SH	10
PSPTB35/50	20
CA701-1M / CA701-1M-S	50 m
CA701-15-1M / CA701-15-1M-S	25 m
CA202 / CA102	50
CA509/K9WHT	100
MHPTB35/50	10
M6	

Uninsulated	Imax	Standard Pack
CA703/9	150 A	10
CA704/9	150 A	10

PTB70/95 & PTB70/95SH

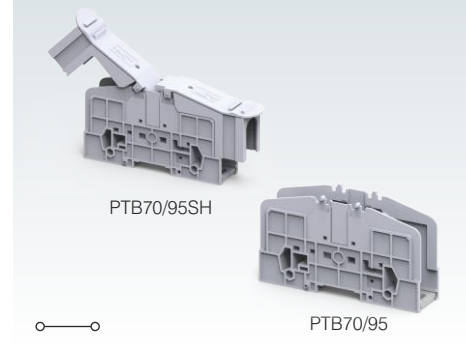

32 x 130 mm / 192 mm (with Shroud)
76.6 mm / 84.5 mm
78 mm / 86 mm

IEC	UL - CSA
1.5 - 95.0 mm ²	8 - 4/0 AWG
1.5 - 95.0 mm ²	8 - 4/0 AWG

IEC60947-7-1	UL-1059	CSA22.2-158	
1000 V	600 V	600 V	
232 A	230 A	230 A	
10.0 Nm	87 lb-in	87 lb-in	
Polyamide 6,6 / 1			
8 KV / 3			

Type / Cat. No.	Standard Pack
PTB70/95	10
PTB70/95SH	10
CA701-1M / CA701-1M-S	50 m
CA701-15-1M / CA701-15-1M-S	25 m
CA202 / CA102	50
CA509/K9WHT	100
MHPTB70/95	10
M8	

Uninsulated	Imax	Standard Pack
CA703/11	220 A	10
CA704/11	220 A	10

* M3 Screw of desired length with nut can be used optionally to secure the stack.

PTB35 with optional MHPTB35

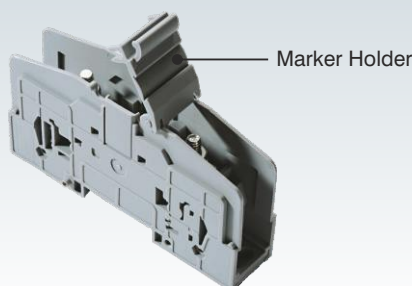

Panel Mounting Hole Details

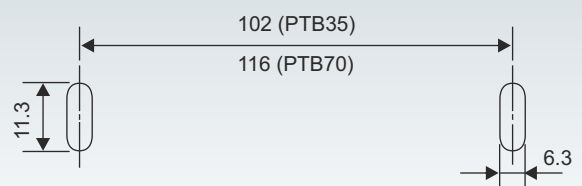

Dimension in mm

POWER TERMINAL BLOCKS

PTB120/150 & PTB120/150SH

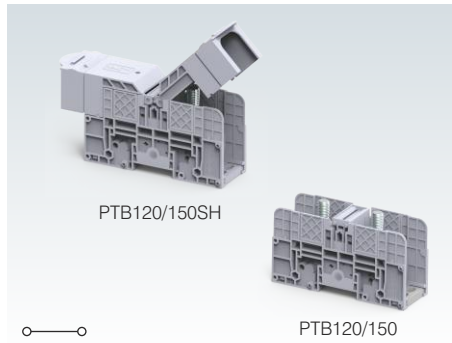

PTB185/240 & PTB185/240SH

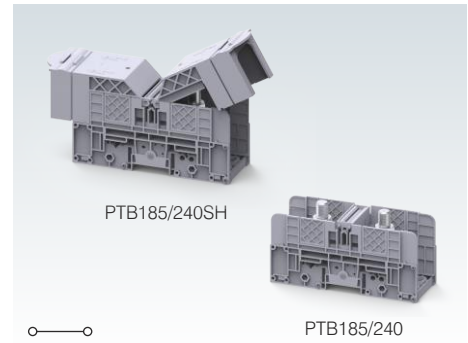

Width (Thickness) x Length	42 x 124 mm / 186 mm (with Shroud)			55 x 152 mm / (with Shroud)		
Height with DIN 35 x 7.5 / 35 x 15 mm Rail	72.3 mm / 79.8 mm 73.8 mm / 83.3 mm			79.9 mm / 87.4 mm		
Connection Possibility as per	IEC			UL - CSA		
With 1 Conductor per clamp	Stranded / Flexible with Ferrule / Lug			10.0 - 240.0 mm ²		
With 2 same size Conductors per clamp	Stranded / Flexible with Ferrule / Lug			10.0 - 240.0 mm ²		
Ratings As Per	IEC60947-7-1	UL-1059	CSA22.2-158	IEC60947-7-1	UL-1059	
Voltage	1000 V	600 V	600 V	1000 V	1000 V	
Current	310 A	285 A	285 A	420 A	415 A	
Torque	10.0 Nm	127 lb-in	127 lb-in	14-30 Nm	127-265 lb-in	
Approvals	IEC CE RUS			IEC CE RUS		
Insulation Material / Material Group	Polyamide 6,6 / 1			Polyamide 6,6 / 1		
Rated Impulse Voltage / Pollution Degree	8 KV / 3			8 KV / 3		

	Type / Cat. No.	Standard Pack	Type / Cat. No.	Standard Pack
Terminal Block	PTB120/150	5	PTB185/240	2
	PTB120/150SH	5	PTB185/240SH	2
Protective Cover	PSPTB120/150	20	PSPTB185	20
Mounting Rail (Refer Pg. 263 for details)	CA701-1M / CA701-1M-S	50 m	CA701-1M / CA701-1M-S	50 m
	CA701-15-1M / CA701-15-1M-S	25 m	CA701-15-1M / CA701-15-1M-S	25 m
End Clamp (Refer Pg. 264 for details)	CA202 / CA102	50	CA202 / CA102	50
Marking Tags (Refer Pg. 268 for details)	CA509/K9WHT	100		100
Bolt Size	M10		M12	

	Uninsulated	I _{max}	Standard Pack	Uninsulated	I _{max}	Standard Pack
Shorting System	CA703/12	300 A	10	CA703/13	420 A	10
	CA704/12	300 A	10	CA704/13	420 A	10

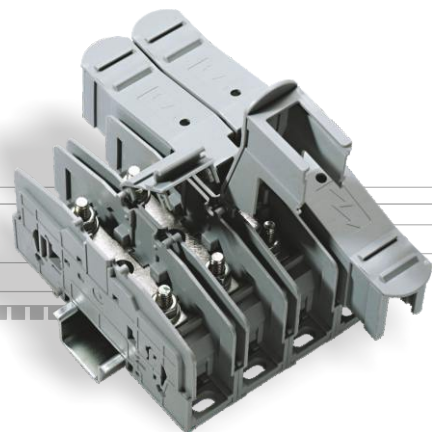

PTB300 & PTB300SH

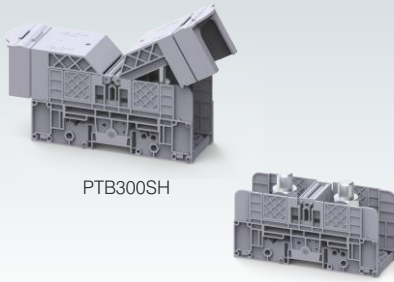

PTB300SH

PTB300

55 x 152 mm / (with Shroud)

79.9 mm / 87.4 mm

IEC	UL - CSA
10.0 - 300.0 mm ²	

10.0 - 300.0 mm²

IEC60947-7-1	UL-1059		
--------------	---------	--	--

1000 V 1000 V

520 A 545 A

25-35 Nm 221-310 lb-in



Polyamide 6,6 / 1

8 KV / 3

Type / Cat. No.	Standard Pack
PTB300	5
PTB300SH	5
PSPTB185	20
CA701-1M / CA701-1M-S	50 m
CA701-15-1M / CA701-15-1M-S	25 m
CA202 / CA102	50
	100
M12	

Uninsulated	Imax	Standard Pack
CA703/14	520 A	10
CA704/14	520 A	10

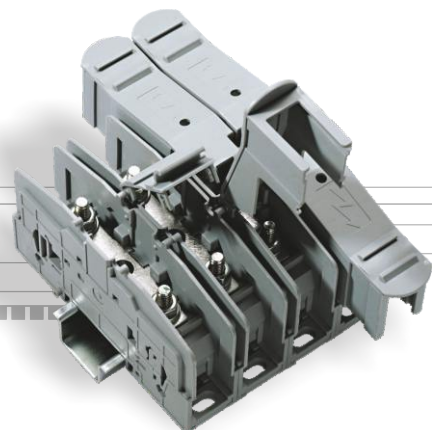

STUD TERMINAL BLOCKS - METRO RAILS

These Stud Terminal Blocks are robust and reliable choice for harsh shock and vibration applications, such as high-speed transportation areas like metro rails.

The wires are crimped to ring type lug and screwed on the terminal. The fastening nut always remains captive thus providing reliable connection.

CSST4, CSST8, CSST10 are Single Stud Terminal Blocks, CSTD5 is a Double Stud Terminal Block.

CSTDE & CSTDE2 are component holder tab connection Terminal Blocks.

These Terminal Blocks comply to DIN / EN45545 , NF-F61017, IEC 61373 shock & vibration standards

CSST4

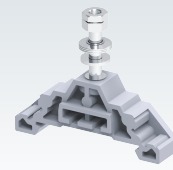

Width (Thickness) x Length	10.5 x 50 mm		
Height with DIN 35 x 7.5 / 35 x 15 mm Rail	45.8 mm / 53.3 mm		
Connection Possibility as per	IEC	UL - CSA	
With 1 Conductor per clamp	Stranded / Flexible with Ferrule / Lug	1.5 - 4.0 mm ²	14 - 10 AWG
	Solid with Ferrule / Lug	1.5 - 4.0 mm ²	
With 2 same size Conductors per clamp	Stranded / Flexible with Ferrule / Lug	1.5 - 4.0 mm ²	14 - 10 AWG
Ratings As Per	IEC60947-7-1		
Voltage	500 V		
Current	32 A		
Torque	1.2 Nm		
Approvals	CE		
Insulation Material / Material Group	Polyamide 6,6 / 1		
Rated Impulse Voltage / Pollution Degree	8 KV / 3		

	Type / Cat. No.	Standard Pack
Terminal Block	CSST4	50
Partition Plate	SPCSST1	50
Mounting Rail (Refer Pg. 263 for details)	CA701-1M / CA701-1M-S	50 m
	CA701-15-1M / CA701-15-1M-S	25 m
End Clamp (Refer Pg. 264 for details)	CA702 / CA802	50
Marking Tags (Refer Pg. 268 for details)	CA509/K8WHT	100
Marker Card (Refer Pg. 269 for details)	MC8	10
Spacer Plate	CSSTSP	30
Stud Size	M4	

	Type / Cat. No.	Standard Pack
Protective Cover	CSSTPC	10
Protective Cover Support Plate	SPCSST3	50

CSST8

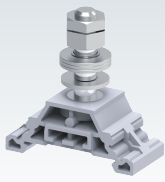

22 x 50 mm
59 mm / 66.5 mm

IEC UL - CSA

6 - 70 mm² 8 - 4/0 AWG

6 - 70 mm²

6 - 70 mm² 8 - 4/0 AWG

IEC60947-7-1

800 V

192 A



Polyamide 6,6 / 1

8 KV / 3

CSST10

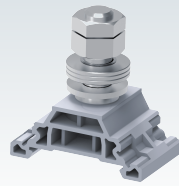

30 x 50 mm
60.3 mm / 67.8 mm

IEC UL - CSA

10 - 120 mm² 6 - 250 KCML

10 - 120 mm²

10 - 120 mm² 6 - 250 KCML

IEC60947-7-1

800 V

269 A



Polyamide 6,6 / 1

8 KV / 3

CSTD5

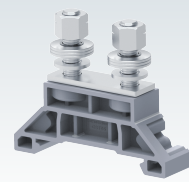

12 x 50 mm
45.8 mm / 53.3 mm

IEC UL - CSA

6 - 10 mm² 8 - 6 AWG

6 - 10 mm²

6 - 10 mm² 8 - 6 AWG

IEC60947-7-1

800 V

57 A



Polyamide 6,6 / 1

8 KV / 3

Type / Cat. No.	Standard Pack
CSST8	25
SPCSST2	50
CA701-1M / CA701-1M-S	50 m
CA701-15-1M / CA701-15-1M-S	25 m
CA702 / CA802	50
CA509/K8WHT	100
MC8	10
CSSTSP	30
M8	

Type / Cat. No.	Standard Pack
CSSTPC	10
SPCSST4	50

Type / Cat. No.	Standard Pack
CSST10	10
SPCSST2	50
CA701-1M / CA701-1M-S	50 m
CA701-15-1M / CA701-15-1M-S	25 m
CA702 / CA802	50
CA509/K8WHT	100
MC8	10
CSSTSP	30
M10	

Type / Cat. No.	Standard Pack
CSSTPC	10
SPCSST4	50

Type / Cat. No.	Standard Pack
CSTD5	50
SPCSST1	50
CA701-1M / CA701-1M-S	50 m
CA701-15-1M / CA701-15-1M-S	25 m
CA702 / CA802	50
CA509/K8WHT	100
MC8	10
CSSTSP	30
M5	

Type / Cat. No.	Standard Pack
CSSTPC	10
SPCSST3	50

STUD TERMINAL BLOCKS - RAILWAYS

CSTDE

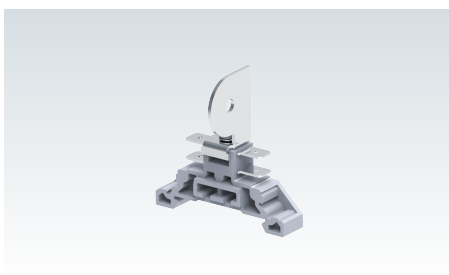

CSTDE2

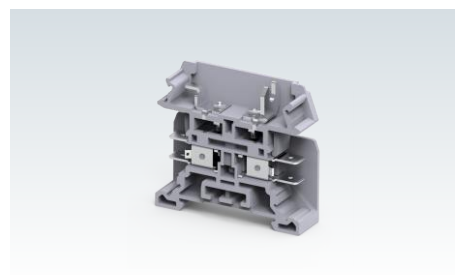

Width (Thickness) x Length	24 x 50 mm
Height with DIN 35 x 7.5 / 35 x 15 mm Rail	53.5 mm / 61 mm
Connection Possibility as per	IEC
With 1 Conductor per clamp	Stranded / Flexible with Ferrule / Lug
With 2 same size Conductors per clamp	Stranded / Flexible with Ferrule / Lug
Ratings As Per	IEC60947-7-1
Voltage	250 V
Current	25 A
Torque	
Approvals	CE
Insulation Material / Material Group	Polyamide 6,6 / 1
Rated Impulse Voltage / Pollution Degree	8 KV / 3

Width (Thickness) x Length	14 x 54 mm
Height with DIN 35 x 7.5 / 35 x 15 mm Rail	52 mm / 59.5 mm
Connection Possibility as per	IEC
With 1 Conductor per clamp	Stranded / Flexible with Ferrule / Lug
With 2 same size Conductors per clamp	Stranded / Flexible with Ferrule / Lug
Ratings As Per	IEC60947-7-1
Voltage	500 V
Current	25 A
Torque	
Approvals	CE
Insulation Material / Material Group	Polyamide 6,6 / 1
Rated Impulse Voltage / Pollution Degree	8 KV / 3

Terminal Block	CSTDE	50
Partition Plate	SPCSST2	50
Mounting Rail (Refer Pg. 263 for details)	CA701-1M / CA701-1M-S	50 m
End Clamp (Refer Pg. 264 for details)	CA702 / CA802	50
Marking Tags (Refer Pg. 268 for details)	CA509/K8WHT	100
Marker Card (Refer Pg. 269 for details)	MC8	10

Type / Cat. No.	Standard Pack
CSTDE	50
SPCSST2	50
CA701-1M / CA701-1M-S	50 m
CA701-15-1M / CA701-15-1M-S	25 m
CA702 / CA802	50
CA509/K8WHT	100
MC8	10

Type / Cat. No.	Standard Pack
CSTDE2	50
SPCSST2	50
CA701-1M / CA701-1M-S	50 m
CA701-15-1M / CA701-15-1M-S	25 m
CA702 / CA802	50
CA509/K10WHT	100
MC10	10

Jumpers	
Protective Cover	CSSTPC
Protective Cover Support Plate	SPCSST4

Type / Cat. No.	Standard Pack
CSSTPC	10
SPCSST4	50

Type / Cat. No.	Standard Pack
CSSTPC	10
SPCSST4	50

MELAMINE

TERMINAL BLOCKS

High Grade Melamine Terminal Blocks are suitable for applications involving high temperature. Connections can be made by simply stripping the wire of its insulation to the recommended length and clamping it without any additional preparation. In no instance does the clamping screw act directly on the wire and this effectively prevents damage to the wire.



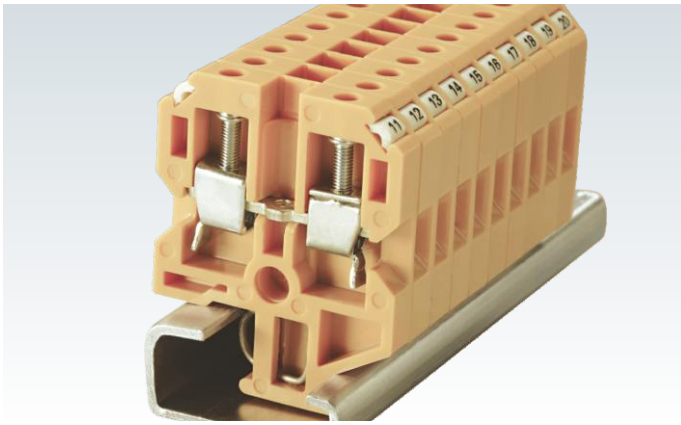

Screw Clamp Terminal Blocks with a high torque clamping system ensuring safe, gas tight connections. Cold forged, rolled threaded screws ensure highly reliable connections.

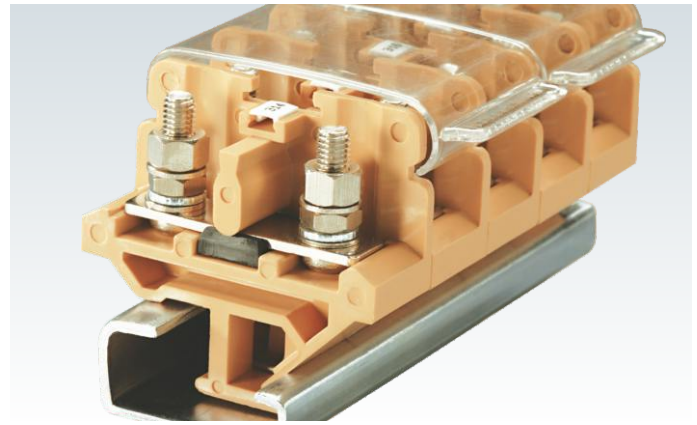

High Torque clamping system for ring & fork type lugs / ferrules. Extremely effective clamping system for areas prone to high vibrations.

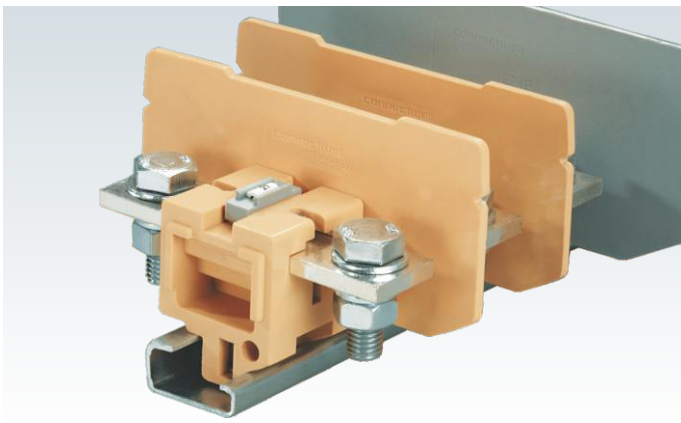

High current terminal blocks provide extremely reliable connection for higher size wires. Additional isolation plates are used to make these assemblies safe.

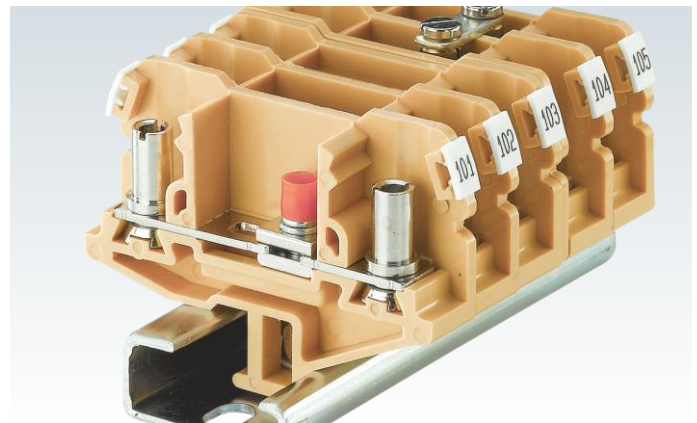

Disconnecting Terminal Block system is a versatile wire connection method for current transformer and power meters. A wide range of accessories eases the testing of these instruments.

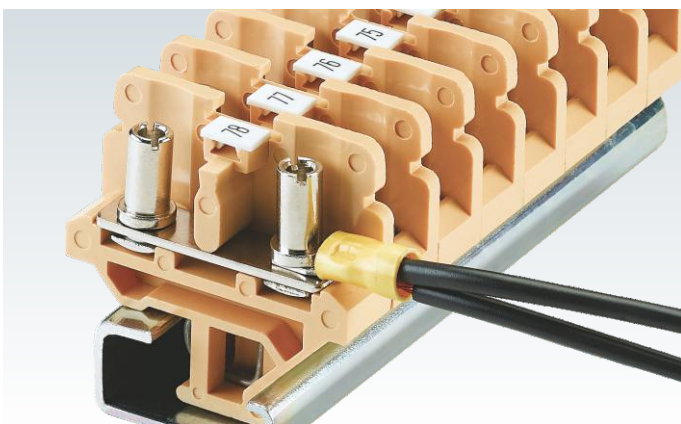

Commercially available ring or fork type lugs / ferrules can be used for terminating multiple wires. The bolt & nut system make these multi wire connections safe and secure.

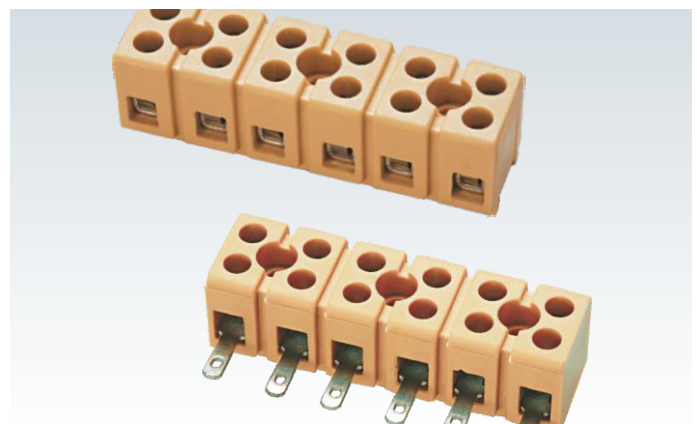

Strip type terminals are used for electric and electronic equipments and smaller junction boxes. They can be cut to different pole configurations.

MELAMINE TERMINAL BLOCKS

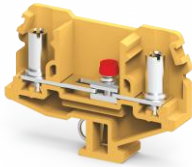
**Feed Through****243 - 245****Stud Type****246 - 250****Disconnect & Test****251 - 252****Bus Bar****253 - 254****Spring Loaded****255 - 256****Multipole Strip****257 - 258****Ceramic Terminal****259 - 260**

STANDARD FEED THROUGH TERMINAL BLOCKS

These Terminal Blocks are ideal choice for use in High Temperature applications. These Terminal Blocks can be mounted on a standard 'G' rail and are available for wire sizes from 0.2 to 35 sq.mm

These Terminal Blocks have marker holding recesses to accept marking tags for circuit identification. Cross connection can be achieved with the aid of jumpers / sleeves & screws. The specially designed 'Knock Out' at the center must be removed to facilitate permanent shorting.

Width (Thickness) x Length		6.7 x 40 mm				
Height with DIN 32 x 15 mm Rail		52 mm				
Connection Possibility as per		IEC		UL - CSA		
With 1 Conductor per clamp	Stranded / Flexible	0.2 - 4.0 mm ²		22 - 10 AWG		
	Solid with Ferrule / Lug	0.2 - 6.0 mm ²		22 - 10 AWG		
With 2 same size Conductors per clamp	Stranded / Flexible	0.2 - 4.0 mm ²		22 - 10 AWG		
	with TWIN Ferrule / Lug	0.2 - 2.5 mm ²		22 - 12 AWG		
Wire Stripping Length		12 mm				
Ratings As Per		IEC60947-7-1 CSA22.2-158				
Voltage		800 V	600 V			
Current		32 A	40 A*			
Torque		0.5 Nm	7 lb-in			
Approvals						
Insulation Material / Comparative Tracking Index		Melamine / 1				
Rated Impulse Voltage / Pollution Degree		8 KV / 3				
		Type / Cat. No.		Standard Pack		
Terminal Block		CTS2.5		200		
		Blue CTS2.5BU		200		
		Red CTS2.5R		200		
		Yellow CTS2.5Y		200		
		Black CTS2.5BK		200		
End Plate		CTSEP1		50		
Partition Plate		CTSP1L CTSP1B		50 50		
Mounting Rail (Refer Pg. 263 for details)		CA501-1M / CA501-1M-S		25 m		
End Clamp (Refer Pg. 264 for details)		CA502 / CA702		50		
Marking Tags (Refer Pg. 268 for details)		CA509/K2WHT		100		
Screw Driver		SCS0.6/3.5 Blade size: 0.6 x 3.5 mm		10		
Jumpers		Uninsulated	Insulated	I_{max}	Standard Pack	
Screw Type Jumpers		2 pole	CA522/2	CA622/2	32 A	100
		3 pole	CA522/3	CA622/3	32 A	100
		4 pole	CA522/4	CA622/4	32 A	100
		10 pole	CA522/10	CA622/10	32 A	10
Jumper Bar		2 pole	CA503/1		32 A	100
		3 pole	CA504/1		32 A	100
		4 pole	CA505/1		32 A	100
		10 pole	CA510/1		32 A	100
Short Sleeve & Screw for configurable jumper bar		CA507/S/Q/01		50		
Short Stud & Screw for configurable jumper bar		CA507/S/01		100		
Switchable Jumper		CA506/01		24 A	100	
Long Sleeve & Screw for Switchable Jumpers		CA507/L/Q/01		100		
Long Stud & Screw for Switchable Jumpers		CA507/L/01		100		
Test Socket		CA707/TS/04		100		

* 40 Amp with two 12 AWG wires
35 Amp with one 10 AWG wire



Width (Thickness) x Length		6.7 x 40 mm			
Height with DIN 32 x 15 mm Rail		52 mm			
Connection Possibility as per		IEC		UL - CSA	
With 1 Conductor per clamp	Stranded / Flexible	0.2 - 4.0 mm ²		22 - 10 AWG	
	Solid with Ferrule / Lug	0.2 - 6.0 mm ²		22 - 10 AWG	
With 2 same size Conductors per clamp	Stranded / Flexible	0.2 - 4.0 mm ²		22 - 10 AWG	
	with TWIN Ferrule / Lug	0.2 - 2.5 mm ²		22 - 12 AWG	
Wire Stripping Length		12 mm			
Ratings As Per		IEC60947-7-1 CSA22.2-158			
Voltage		800 V	600 V		
Current		32 A	40 A*		
Torque		0.5 Nm	7 lb-in		

Approvals: Melamine / 1
Rated Impulse Voltage / Pollution Degree: 8 KV / 3

		Type / Cat. No.	Standard Pack	
Terminal Block		CTS2.5	200	
		Blue CTS2.5BU	200	
		Red CTS2.5R	200	
		Yellow CTS2.5Y	200	
		Black CTS2.5BK	200	
End Plate		CTSEP1	50	
Partition Plate		CTSP1L CTSP1B	50 50	
Mounting Rail (Refer Pg. 263 for details)		CA501-1M / CA501-1M-S	25 m	
End Clamp (Refer Pg. 264 for details)		CA502 / CA702	50	
Marking Tags (Refer Pg. 268 for details)		CA509/K2WHT	100	
Screw Driver		SCS0.6/3.5 Blade size: 0.6 x 3.5 mm	10	

		Uninsulated	Insulated	I _{max}	Standard Pack	
Screw Type Jumpers		2 pole	CA522/2	CA622/2	32 A	100
		3 pole	CA522/3	CA622/3	32 A	100
		4 pole	CA522/4	CA622/4	32 A	100
		10 pole	CA522/10	CA622/10	32 A	10
Jumper Bar		2 pole	CA503/1		32 A	100
		3 pole	CA504/1		32 A	100
		4 pole	CA505/1		32 A	100
		10 pole	CA510/1		32 A	100
Short Sleeve & Screw for configurable jumper bar		CA507/S/Q/01		50		
Short Stud & Screw for configurable jumper bar		CA507/S/01		100		
Switchable Jumper		CA506/01		24 A	100	
Long Sleeve & Screw for Switchable Jumpers		CA507/L/Q/01		100		
Long Stud & Screw for Switchable Jumpers		CA507/L/01		100		
Test Socket		CA707/TS/04		100		

* 40 Amp with two 12 AWG wires
35 Amp with one 10 AWG wire

CTS6



8 x 40 mm

52 mm

IEC	UL - CSA
1.5 - 6.0 mm ²	22 - 8 AWG
1.5 - 6.0 mm ²	22 - 8 AWG
1.5 - 4.0 mm ²	22 - 10 AWG
1.5 - 4.0 mm ²	22 - 10 AWG

10 mm

IEC60947-7-1 CSA22.2-158

1000 V	600 V		
41 A	50 A		
0.8 Nm	14 lb-in		



Melamine / 1

Type / Cat. No.	Standard Pack
CTS6	200
CTS6BU	200
CTS6R	200
CTS6Y	200
CTS6BK	200
CTSEP1	50
CTSP1L	50
CTSP1B	50
CA501-1M / CA501-1M-S	25 m
CA502 / CA702	50
CA509/K2WHT	100
SCS0.8/4 Blade size: 0.8 x 4 mm	10

Uninsulated	Insulated	I _{max}	Standard Pack
CA723/2	CA743/2	41 A	100
CA723/3	CA743/3	41 A	100
CA723/4	CA743/4	41 A	100
CA723/10	CA743/10	41 A	10
CA703/2		41 A	100
CA704/2		41 A	100
CA705/2		41 A	100
CA733/10		41 A	100

CA707/S/Q/1			100
CA507/S/1			100
CA706/2		41 A	100
CA707/L/Q/1			100
CA507/L/1			100
CA707/TS/05			100

CTS10



10 x 40 mm

52 mm

IEC	UL - CSA
1.5 - 10.0 mm ²	22 - 6 AWG
1.5 - 10.0 mm ²	22 - 6 AWG
1.5 - 6.0 mm ²	22 - 8 AWG
1.5 - 6.0 mm ²	22 - 10 AWG

12 mm

IEC60947-7-1 CSA22.2-158

1000 V	600 V		
57 A	65 A		
1.2 Nm	14 lb-in		



Melamine / 1

8 KV / 3

Type / Cat. No.	Standard Pack
CTS10	200
CTS10BU	200
CTS10R	200
CTS10Y	200
CTS10BK	200
CTSEP1	50
CTSP1L	50
CTSP1B	50
CA501-1M / CA501-1M-S	25 m
CA502 / CA702	50
CA509/K2WHT	100
SCS0.8/4 Blade size: 0.8 x 4 mm	10

Uninsulated	Insulated	I _{max}	Standard Pack
CA724/2	CA744/2	57 A	100
CA724/3	CA744/3	57 A	100
CA724/4	CA744/4	57 A	100
CA724/10	CA744/10	57 A	10
CA703/3		57 A	100
CA704/3		57 A	100
CA705/3		57 A	100
CA734/10		57 A	100

CA707/S/Q/1			100
CA507/S/2			100
CA706/3		24 A	100
CA707/L/Q/1			100
CA507/L/2			100
CA707/TS/05			100

CTS16

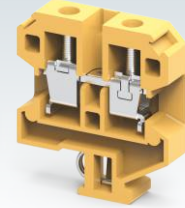

12 x 50 mm

57.5 mm

IEC	UL - CSA
6.0 - 16.0 mm ²	20 - 4 AWG
6.0 - 16.0 mm ²	20 - 4 AWG
6.0 - 10.0 mm ²	20 - 8 AWG
6.0 - 10.0 mm ²	20 - 8 AWG

14 mm

IEC60947-7-1 CSA22.2-158

1000 V	600 V		
76 A	85 A		
1.2 Nm	14 lb-in		



Melamine / 1

8 KV / 3

Type / Cat. No.	Standard Pack
CTS16	100
CTS16BU	100
CTS16R	100
CTS16Y	100
CTS16BK	100
CTSEP2	50
CTSP2	50
CA501-1M / CA501-1M-S	25 m
CA502 / CA702	50
CA509/K2WHT	100
SCS0.8/4 Blade size: 0.8 x 4 mm	10

Uninsulated	Insulated	I _{max}	Standard Pack
CA751/2	CA761/2	65 A	50
CA751/3	CA761/3	65 A	50
CA751/4	CA761/4	65 A	50
CA751/10	CA761/10	65 A	10
CA703/8		65 A	100
CA704/8		65 A	100
CA705/8		65 A	100
CA739/10		65 A	100

CA507/S/Q/1			100
CA507/S/2			100
CA706/8		65 A	100
CA707/L/Q/1			100
CA507/L/2			100
CA707/TS/05			100

STANDARD FEED THROUGH TERMINAL BLOCKS

CTS35

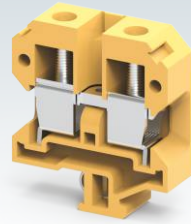

Width (Thickness) x Length	18 x 58 mm		
Height with DIN 32 x 15 mm Rail	66.8 mm		
Connection Possibility as per	IEC	UL - CSA	
With 1 Conductor per clamp	Stranded / Flexible	10.0 - 35.0 mm ²	8 - 2 AWG
	with Ferrule / Lug	10.0 - 35.0 mm ²	8 - 2 AWG
With 2 same size Conductors per clamp	Stranded / Flexible	10.0 - 16.0 mm ²	8 - 6 AWG
	with TWIN Ferrule / Lug	10.0 - 16.0 mm ²	8 - 6 AWG
Wire Stripping Length	20 mm		
Ratings As Per	IEC60947-7-1 CSA22.2-158		
Voltage	1100 V	600 V	
Current	125 A	145 A	
Torque	2.5 Nm	25 lb-in	
Approvals			
Insulation Material / Comparative Tracking Index	Melamine / 1		
Rated Impulse Voltage / Pollution Degree	8 KV / 3		

	Type / Cat. No.	Standard Pack
Terminal Block	CTS35	50
	Blue CTS35BU	50
	Red CTS35R	50
	Yellow CTS35Y	50
	Black CTS35BK	50
End Plate	CTSEP3	25
Partition Plate	CTSPP3	25
Mounting Rail (Refer Pg. 263 for details)	CA501-1M / CA501-1M-S	25 m
End Clamp (Refer Pg. 264 for details)	CA502 / CA702	50
Marking Tags (Refer Pg. 268 for details)	CA509/K2WHT	100
Screw Driver	SCS1.0/5.5 Blade size: 1.0 x 5.5 mm	10

	Uninsulated	Insulated	I _{max}	Standard Pack
Screw Type Jumpers	2 pole			
	3 pole			
	4 pole			
	10 pole			
Jumper Bar	2 pole	CA503/5	125 A	100
	3 pole	CA504/5	125 A	100
	4 pole	CA505/5	125 A	100
	10 pole	CA510/5	125 A	100
Short Sleeve & Screw for configurable jumper bar		CA508/S/Q		100
Short Stud & Screw for configurable jumper bar		CA508/S		100
Switchable Jumper		CA506/5	125 A	100
Long Sleeve & Screw for Switchable Jumpers		CA508/L/Q		100
Long Stud & Screw for Switchable Jumpers		CA508/L		100
Test Socket		CA707/TS/06		100

STUD TYPE TERMINAL BLOCKS

These Terminal Blocks are preferred for applications where the connections are subjected to severe vibrations.

The wire is crimped to a ring / fork type lug (ferrule) and is screwed on to the flat current bar on the Terminal Block. The range includes Terminal Blocks for wire sizes from 0.25 to 35sq.mm.

Cross connection can be achieved with the aid of external jumpers.

It is recommended to use protective covers in transparent plastic to fully shroud these assemblies.

CSTSB3



Width (Thickness) x Length	10 x 50 mm		
Height with DIN 32 x 15 mm Rail	47.5 mm		
Connection Possibility as per	IEC	UL - CSA	
With 1 Conductor per clamp	Stranded / Flexible with Ferrule / Lug	1.5 - 6.0 mm ²	22 - 10 AWG
	Solid with Ferrule / Lug	1.5 - 6.0 mm ²	
With 2 same size Conductors per clamp	Stranded / Flexible with Ferrule / Lug	1.5 - 2.5 mm ²	22 - 12 AWG
Wire Stripping Length	9 mm		
Ratings As Per	IEC60947-7-1 CSA22.2-158		
Voltage	1100 V	600 V	
Current	41 A	35 A	
Torque	0.5 Nm	7 lb-in	
Approvals			
Insulation Material / Comparative Tracking Index	Melamine / 1		
Rated Impulse Voltage / Pollution Degree	8 KV / 3		

	Type / Cat. No.	Standard Pack
Terminal Block	CSTSB3	100
	CSTSB3BU	100
	CSTSB3R	100
	CSTSB3Y	100
	CSTSB3BK	100
End Plate	CSTSEP2	50
Partition Plate	CSTSPPP	50
Mounting Rail (Refer Pg. 263 for details)	CA501-1M / CA501-1M-S	25 m
End Clamp (Refer Pg. 264 for details)	CA502 / CA702	50
Marking Tags (Refer Pg. 268 for details)	CA509/K2B4WHT	100
Screw Driver	SCS0.8/4 Blade size: 0.8 x 4 mm	10
Stud Size		

Jumpers	Type / Cat. No.	I _{max}	Standard Pack
Uninsulated Removable Jumper	2 pole	32 A	100
	3 pole	32 A	50
	4 pole	32 A	50
Insulated Removable Jumper	2 pole	32 A	100
	3 pole	32 A	50
	4 pole	32 A	50
Permanent Uninsulated Jumper	2 pole	32 A	100
	3 pole	32 A	50
	4 pole	32 A	50
Permanent Insulated Jumper	2 pole	32 A	100
	3 pole	32 A	50
	4 pole	32 A	50
Protective Cover	2 Terminal		100
	3 Terminal		100
Long Protective Cover	100 mm		10
	200 mm		10
	300 mm		10

STUD TYPE TERMINAL BLOCKS

CSTSB4/N4

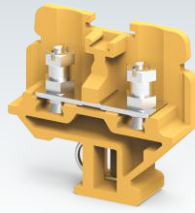

CSTSB5

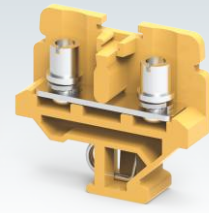

Width (Thickness) x Length	13 x 45.0 mm		13 x 50 mm	
Height with DIN 32 x 15 mm Rail	45.0 mm		47.5 mm	
Connection Possibility as per	IEC	UL - CSA	IEC	UL - CSA
With 1 Conductor per clamp	Stranded / Flexible with Ferrule / Lug Solid with Ferrule / Lug	1.5 - 10.0 mm ²	22 - 6 AWG	1.5 - 16.0 mm ² 22 - 4 AWG
With 2 same size Conductors per clamp	Stranded / Flexible with Ferrule / Lug	1.5 - 10.0 mm ²	22 - 6 AWG	1.5 - 6.0 mm ² 22 - 8 AWG
Wire Stripping Length	12 mm		12 mm	
Ratings As Per	IEC60947-7-1		IEC60947-7-1 CSA22.2-158	
Voltage	1100 V		1000 V	600 V
Current	57 A		76 A	80 A
Torque	1.2 Nm		2.0 Nm	25 lb-in
Approvals	CE		IEC CE C-SP	
Insulation Material / Comparative Tracking Index	Melamine / 1		Melamine / 1	
Rated Impulse Voltage / Pollution Degree	8 KV / 3		8 KV / 3	

	Type / Cat. No.	Standard Pack	Type / Cat. No.	Standard Pack
Terminal Block	CSTSB4/N4	100	CSTSB5	100
	Blue CSTSB4/N4BU	100	CSTSB5BU	100
	Red CSTSB4/N4R	100	CSTSB5R	100
	Yellow CSTSB4/N4Y	100	CSTSB5Y	100
	Black CSTSB4/N4BK	100	CSTSB5BK	100
End Plate	EPCSTSB4/N4	50	CSTSEP2	50
Partition Plate			CSTSPPP	50
Mounting Rail (Refer Pg. 263 for details)	CA501-1M / CA501-1M-S	25 m	CA501-1M / CA501-1M-S	25 m
End Clamp (Refer Pg. 264 for details)	CA502 / CA702	50	CA502 / CA702	50
Marking Tags (Refer Pg. 268 for details)	CA509/K2B4WHT	100	CA509/K2B4WHT	100
Screw Driver	SCS1.0/5.5 Blade size: 1.0 x 5.5 mm	10	SCS1.0/5.5 Blade size: 1.0 x 5.5 mm	10
Stud Size	M4			

	Type / Cat. No.	I _{max}	Standard Pack	Type / Cat. No.	I _{max}	Standard Pack
Uninsulated Removable Jumper	2 pole	45 A	100	CA512/2-2	45 A	100
	3 pole	45 A	50	CA512/2-3	45 A	50
	4 pole	45 A	50	CA512/2-4	45 A	50
Insulated Removable Jumper	2 pole	45 A	100	CA514/2-2	45 A	100
	3 pole	45 A	50	CA514/2-3	45 A	50
	4 pole	45 A	50	CA514/2-4	45 A	50
Permanent Uninsulated Jumper	2 pole	45 A	100	CA512/4-2	45 A	100
	3 pole	45 A	50	CA512/4-3	45 A	50
	4 pole	45 A	50	CA512/4-4	45 A	50
Permanent Insulated Jumper	2 pole	45 A	100	CA514/4-2	45 A	100
	3 pole	45 A	50	CA514/4-3	45 A	50
	4 pole	45 A	50	CA514/4-4	45 A	50
Protective Cover	2 Terminal			CSTSPC2		100
	3 Terminal			CSTSPC2-1		100
Long Protective Cover	100 mm		10	CSTSPC1-2		10
	200 mm		10	CSTSPC1-3		10
	300 mm		10	CSTSPC1-4		10
	CSTSPC1-5					
	CSTSPC1-6					
	CSTSPC1-7					

CSTSN4

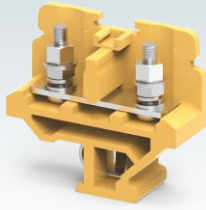

17 x 50 mm

47.5 mm

IEC	UL - CSA
1.5 - 10.0 mm ²	22 - 6 AWG

1.5 - 6.0 mm ²	22 - 8 AWG
---------------------------	------------

12 mm

IEC60947-7-1 CSA22.2-158

1100 V	600 V		
57 A	65 A		
1.2 Nm	14 lb-in		



Melamine / 1

8 KV / 3

Type / Cat. No.	Standard Pack
CSTSN4	100
CSTSN4BU	100
CSTSN4R	100
CSTSN4Y	100
CSTSN4BK	100
CSTSEP2	50
CSTSP	50
CA501-1M / CA501-1M-S	25 m
CA502 / CA702	50
CA509/K2B4WHT	100

CSTSN415

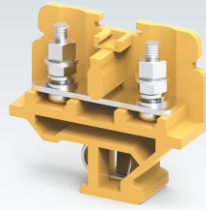

15 x 50 mm

47.5 mm

IEC	UL - CSA
1.5 - 10.0 mm ²	22 - 6 AWG

1.5 - 6.0 mm ²	22 - 8 AWG
---------------------------	------------

12 mm

IEC60947-7-1 CSA22.2-158

1000 V	600 V		
57 A	65 A		
1.2 Nm	14 lb-in		



Melamine / 1

8 KV / 3

Type / Cat. No.	Standard Pack
CSTSN415	100
CSTSN415BU	100
CSTSN415R	100
CSTSN415Y	100
CSTSN415BK	100
CSTSEP2	50
CSTSP	50
CA501-1M / CA501-1M-S	25 m
CA502 / CA702	50
CA509/K2B4WHT	100

Type / Cat. No.	I _{max}	Standard Pack
CA512/1-2	45 A	100
CA512/1-3	45 A	50
CA512/1-4	45 A	50
CA514/1-2	45 A	100
CA514/1-3	45 A	50
CA514/1-4	45 A	50
CA512/3-2	45 A	100
CA512/3-3	45 A	50
CA512/3-4	45 A	50
CA514/3-2	45 A	100
CA514/3-3	45 A	50
CA514/3-4	45 A	50
CSTSPC1		100
CSTSPC1-1		100
CSTSPC1-2		10
CSTSPC1-3		10
CSTSPC1-4		10

Type / Cat. No.	I _{max}	Standard Pack
CA512/9-2	45 A	100
CA512/9-3	45 A	50
CA512/9-4	45 A	50
CA514/9-2	45 A	100
CA514/9-3	45 A	50
CA514/9-4	45 A	50
CA512/10-2	45 A	100
CA512/10-3	45 A	50
CA512/10-4	45 A	50
CA514/10-2	45 A	100
CA514/10-3	45 A	50
CA514/10-4	45 A	50
CSTSPC1		100
CSTSPC1-1		100
CSTSPC1-2		10
CSTSPC1-3		10
CSTSPC1-4		10

STUD TYPE TERMINAL BLOCKS

CSTSN5

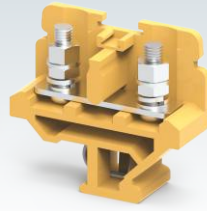

CSTSN515

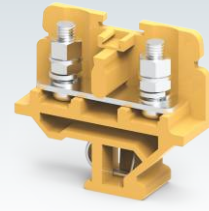

Width (Thickness) x Length	17 x 50 mm		15 x 50 mm	
Height with DIN 32 x 15 mm Rail	47.5 mm		47.5 mm	
Connection Possibility as per	IEC	UL - CSA	IEC	UL - CSA
With 1 Conductor per clamp	Stranded / Flexible with Ferrule / Lug	1.5 - 16.0 mm ²	22 - 4 AWG	1.5 - 16.0 mm ²
With 2 same size Conductors per clamp	Solid with Ferrule / Lug	1.5 - 6.0 mm ²	22 - 8 AWG	1.5 - 6.0 mm ²
Wire Stripping Length	12 mm		12 mm	
Ratings As Per	IEC60947-7-1 CSA22.2-158		IEC60947-7-1 CSA22.2-158	
Voltage	1100 V	600 V	1000 V	600 V
Current	76 A	80 A	76 A	80 A
Torque	2.0 Nm	25 lb-in	2.0 Nm	25 lb-in
Approvals				
Insulation Material / Comparative Tracking Index	Melamine / 1		Melamine / 1	
Rated Impulse Voltage / Pollution Degree	8 KV / 3		8 KV / 3	

	Type / Cat. No.	Standard Pack	Type / Cat. No.	Standard Pack
Terminal Block	CSTSN5	100	CSTSN515	100
	Blue CSTSN5BU	100	CSTSN515BU	100
	Red CSTSN5R	100	CSTSN515R	100
	Yellow CSTSN5Y	100	CSTSN515Y	100
	Black CSTSN5BK	100	CSTSN515BK	100
End Plate	CSTSEP2	50	CSTSEP2	50
Partition Plate	CSTSP	50	CSTSP	50
Mounting Rail (Refer Pg. 263 for details)	CA501-1M / CA501-1M-S	25 m	CA501-1M / CA501-1M-S	25 m
End Clamp (Refer Pg. 264 for details)	CA502 / CA702	50	CA502 / CA702	50
Marking Tags (Refer Pg. 268 for details)	CA509/K2B4WHT	100	CA509/K2B4WHT	100
Stud Size	M5		M5	
Marker Mounting Carrier				

	Type / Cat. No.	I _{max}	Standard Pack	Type / Cat. No.	I _{max}	Standard Pack
Uninsulated Removable Jumper	2 pole CA512/1-2	45 A	100	CA512/9-2	45 A	100
	3 pole CA512/1-3	45 A	50	CA512/9-3	45 A	50
	4 pole CA512/1-4	45 A	50	CA512/9-4	45 A	50
Insulated Removable Jumper	2 pole CA514/1-2	45 A	100	CA514/9-2	45 A	100
	3 pole CA514/1-3	45 A	50	CA514/9-3	45 A	50
	4 pole CA514/1-4	45 A	50	CA514/9-4	45 A	50
Permanent Uninsulated Jumper	2 pole CA512/3-2	45 A	100	CA512/10-2	45 A	100
	3 pole CA512/3-3	45 A	50	CA512/10-3	45 A	50
	4 pole CA512/3-4	45 A	50	CA512/10-4	45 A	50
Permanent Insulated Jumper	2 pole CA514/3-2	45 A	100	CA514/10-2	45 A	100
	3 pole CA514/3-3	45 A	50	CA514/10-3	45 A	50
	4 pole CA514/3-4	45 A	50	CA514/10-4	45 A	50
Protective Cover	2 Terminal CSTSPC1		100	CSTSPC4		100
	3 Terminal CSTSPC1-1		100	CSTSPC4-1		100
Long Protective Cover	90 mm CSTSPC1-2		10	CSTSPC1-2		10
	100 mm					
	150 mm CSTSPC1-3		10	CSTSPC1-3		10
	200 mm CSTSPC1-4		10	CSTSPC1-4		10
300 mm						
Protective Cover Holder	CSP1		100	CSP1		100

DISCONNECT & TEST TERMINAL BLOCKS

These blocks are used for measuring, control, regulatory circuits and for current transformer connection application. They provide a clear functional advantage for devices having utility instruments and associated transformers.

In CMDT4 terminal the disconnection of circuit is achieved by means of a central sliding link assembly with a clear orange indicator.

In the CMDT4S Terminal Block the orange indicator is replaced by a socket headed screw for achieving the circuit disconnection.

Cross connection is possible with the aid of external jumpers.

Barrel nuts provide test sockets for inserting test plugs and for carrying out current and voltage injection protocols.

CMDT4

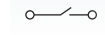
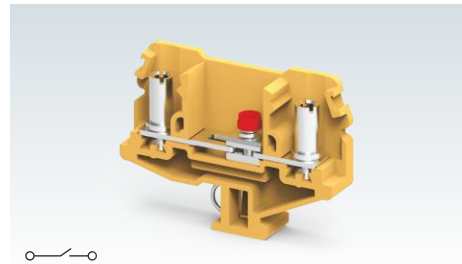

Width (Thickness) x Length	13 x 68 mm		
Height with DIN 32 x 15 mm Rail	51.7 mm		
Connection Possibility as per	IEC	UL - CSA	
With 1 Conductor per clamp	Stranded / Flexible with Ferrule / Lug	1.5 - 6.0 mm ²	22 - 8 AWG
With 2 same size Conductors per clamp	Solid with Ferrule / Lug	1.5 - 6.0 mm ²	22 - 8 AWG
Wire Stripping Length	12 mm		
Ratings As Per	IEC60947-7-1		
Voltage	1100 V		
Current	41 A		
Torque	1.2 Nm		
Approvals			
Insulation Material / Comparative Tracking Index	Melamine / 1		
Rated Impulse Voltage / Pollution Degree	8 KV / 3		

	Type / Cat. No.	Standard Pack
Terminal Block	CMDT4	50
	CMDT4BU	50
	CMDT4R	50
	CMDT4Y	50
	CMDT4BK	50
	EPCMDT4	50
End Plate	EPCMDT4	50
Mounting Rail (Refer Pg. 263 for details)	CA501-1M / CA501-1M-S	25 m
End Clamp (Refer Pg. 264 for details)	CA502 / CA702	50
Marking Tags (Refer Pg. 268 for details)	CA509/K2B4WHT	100
Screw Driver	SCS1.0/5.5 Blade size: 1.0 x 5.5 mm	10

	Type / Cat. No.	I _{max}	Standard Pack
Uninsulated Removable Jumper	2 pole	41 A	100
	3 pole	41 A	50
	4 pole	41 A	50
Insulated Removable Jumper	2 pole	41 A	100
	3 pole	41 A	50
	4 pole	41 A	50
Permanent Uninsulated Jumper	2 pole	41 A	100
	3 pole	41 A	50
	4 pole	41 A	50
Permanent Insulated Jumper	2 pole	41 A	100
	3 pole	41 A	50
	4 pole	41 A	50
Protective Cover	2 Terminal		100
	3 Terminal		100
Long Protective Cover	100 mm		10
	200 mm		10
	300 mm		10
	CDTPC1		100
	CDTPC2		100

CMDT4S

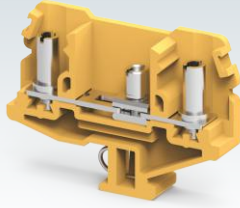

13 x 68 mm

51.7 mm

IEC	UL - CSA
1.5 - 6.0 mm ²	22 - 8 AWG

1.5 - 6.0 mm² 22 - 8 AWG

12 mm

IEC60947-7-1

1100 V

41 A

1.2 Nm



Melamine / 1

8 KV / 3

Type / Cat. No.	Standard Pack
CMDT4S	50
EPCMDT4	50
CA501-1M / CA501-1M-S	25 m
CA502 / CA702	50
CA509/K2B4WHT	100
SCS1.0/5.5 Blade size: 1.0 x 5.5 mm	10

Type / Cat. No.	I _{max}	Standard Pack
CA512/2-2	41 A	100
CA512/2-3	41 A	50
CA512/2-4	41 A	50
CA514/2-2	41 A	100
CA514/2-3	41 A	50
CA514/2-4	41 A	50
CA512/4-2	41 A	100
CA512/4-3	41 A	50
CA512/4-4	41 A	50
CA514/4-2	41 A	100
CA514/4-3	41 A	50
CA514/4-4	41 A	50
CDTPC1		100
CDTPC2		100
CDTPC3		10
CDTPC4		10
CDTPC5		10

CMDT4SH

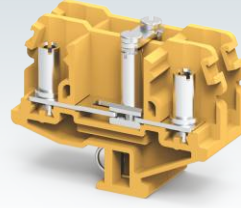

26 x 68 mm

51.7 mm

IEC	UL - CSA
1.5 - 6.0 mm ²	22 - 8 AWG

1.5 - 6.0 mm² 22 - 8 AWG

12 mm

IEC60947-7-1

500 V

32 A

1.2 Nm



Melamine / 1

8 KV / 3

Type / Cat. No.	Standard Pack
CMDT4SH	25
CMDT4SHBU	25
CMDT4SHR	25
CMDT4SHY	25
CMDT4SHBK	25
EPCMDT4	50
CA501-1M / CA501-1M-S	25 m
CA502 / CA702	50
CA509/K2B4WHT	100
SCS1.0/5.5 Blade size: 1.0 x 5.5 mm	10

Type / Cat. No.	I _{max}	Standard Pack
CA512/2-2	32 A	100
CA512/2-3	32 A	50
CA512/2-4	32 A	50
CA514/2-2	32 A	100
CA514/2-3	32 A	50
CA514/2-4	32 A	50
CA512/4-2	32 A	100
CA512/4-3	32 A	50
CA512/4-4	32 A	50
CA514/4-2	32 A	100
CA514/4-3	32 A	50
CA514/4-4	32 A	50

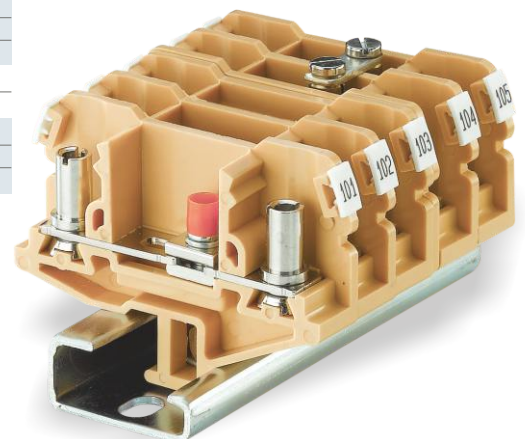

BUS BAR TYPE TERMINAL BLOCKS

These Terminal Blocks are preferred for applications using wires of a large cross section. The wire is crimped to a ring / fork type lug (ferrule) and is screwed on to the flat current bar on the Terminal Block. The range includes Terminal Blocks for wire sizes from 16 sq.mm to 120 sq.mm. Terminal Blocks with suffix LS have a threading in the current bar, eliminating the need of locking nuts.

Partition / Isolation Plate must be used with every Terminal Block. The Protective Cover is designed to be mounted on a specially designed slot in the Partition Plate.

Installation instruction:

It is recommended to provide a back support to the wire while tightening the clamping bolt to avoid deformation of the mounting rail or to prevent damage of the Terminal Block by torsional force.

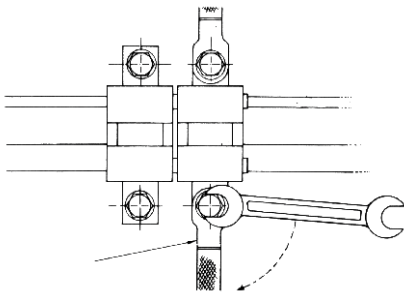

Width (Thickness) x Length		28 x 75 mm	
Height with DIN 32 x 15 mm Rail		55.2 mm	
Connection Possibility as per		IEC	UL - CSA
With 1 Conductor per clamp	Stranded / Flexible with Ferrule / Lug	16.0 - 50.0 mm ²	8 - 2 AWG
With 2 same size Conductors per clamp	Stranded / Flexible with Ferrule / Lug	16.0 - 50.0 mm ²	8 - 2 AWG
Wire Stripping Length		12 mm	
Ratings As Per		IEC60947-7-1 CSA22.2-158	
Voltage		1000 V	600 V
Current		150 A	145 A
Torque		3.0 Nm	27 lb-in
Approvals			
Insulation Material / Comparative Tracking Index		Melamine / 1	
Rated Impulse Voltage / Pollution Degree		8 KV / 3	
		Type / Cat. No.	Standard Pack
Terminal Block	With Nut & Bolt configuration With Threaded Current Bar	CTS35L CTS35LS	10 10
Partition / Isolation Plate (Polyamide 66)		EP4P	10
Partition / Isolation Plate (Melamine)		CTSEP4	10
Locating Support for Partition / Isolation Plate		CTSEP4LO	10
Mounting Rail (Refer Pg. 263 for details)		CA501-1M / CA501-1M-S	25 m
End Clamp (Refer Pg. 264 for details)		CA502 / CA702 / CA102	50
Marking Tags (Refer Pg. 268 for details)		CA509/K2B4WHT	100
Bolt Size		M6	
Jumpers		Type / Cat. No.	Imax
Jumpers	2 pole 3 pole	CA796/2 CA796/3	125 A 125 A
		Mounted on	
Long Protective Cover	Length 90 mm 210 mm 100 mm 190 mm	CTSPC3-2 CTSPC2-1 CTSPC2-2	EP4P CTSEP4 CTSEP4
			10 10 10

CTS35L / CTS35LS



Width (Thickness) x Length		28 x 75 mm	
Height with DIN 32 x 15 mm Rail		55.2 mm	
Connection Possibility as per		IEC	UL - CSA
With 1 Conductor per clamp	Stranded / Flexible with Ferrule / Lug	16.0 - 50.0 mm ²	8 - 2 AWG
With 2 same size Conductors per clamp	Stranded / Flexible with Ferrule / Lug	16.0 - 50.0 mm ²	8 - 2 AWG
Wire Stripping Length		12 mm	
Ratings As Per		IEC60947-7-1 CSA22.2-158	
Voltage		1000 V	600 V
Current		150 A	145 A
Torque		3.0 Nm	27 lb-in
Approvals			
Insulation Material / Comparative Tracking Index		Melamine / 1	
Rated Impulse Voltage / Pollution Degree		8 KV / 3	

Type / Cat. No.	Standard Pack
CTS35L	10
CTS35LS	10
EP4P	10
CTSEP4	10
CTSEP4LO	10
CA501-1M / CA501-1M-S	25 m
CA502 / CA702 / CA102	50
CA509/K2B4WHT	100
M6	

Type / Cat. No.	Imax	Standard Pack
CA796/2	125 A	10
CA796/3	125 A	10
Mounted on		
CTSPC3-2	EP4P	10
CTSPC2-1	CTSEP4	10
CTSPC2-2	CTSEP4	10

CTS70L / CTS70LS

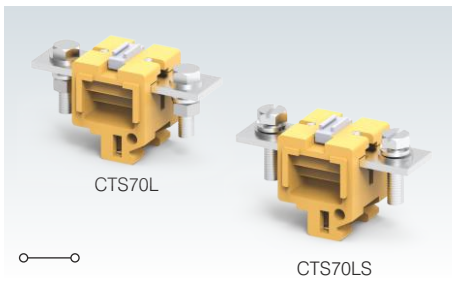

40 x 92 mm

55.2 mm

IEC	UL - CSA
-----	----------

35.0 - 70.0 mm ²	8 - 2/0 AWG
-----------------------------	-------------

35.0 - 70.0 mm ²	8 - 2/0 AWG
-----------------------------	-------------

18 mm

IEC60947-7-1 CSA22.2-158

1000 V	600 V		
--------	-------	--	--

192 A	250 A		
-------	-------	--	--

10.0 Nm	87 lb-in		
---------	----------	--	--



Melamine / 1

8 KV / 3

Type / Cat. No.	Standard Pack
CTS70L	10
CTS70LS	10
EP4P	10
CTSEP4	10
CTSEP4LO	10
CA501-1M / CA501-1M-S	25 m
CA502 / CA702 / CA102	50
CA509/K2B4WHT	100
M8	

Type / Cat. No.	I _{max}	Standard Pack
CA797/2	185 A	10
CA797/3	185 A	10
Mounted on		
CTSPC3-2	EP4P	10
CTSPC2-1	CTSEP4	10
CTSPC2-2	CTSEP4	10

CTS95L / CTS95LS



40 x 92 mm

55.2 mm

IEC	UL - CSA
-----	----------

35.0 - 95.0 mm ²	8 - 4/0 AWG
-----------------------------	-------------

35.0 - 95.0 mm ²	8 - 4/0 AWG
-----------------------------	-------------

20 mm

IEC60947-7-1 CSA22.2-158

1000 V	600 V		
--------	-------	--	--

232 A	300 A		
-------	-------	--	--

10.0 Nm	87 lb-in		
---------	----------	--	--



Melamine / 1

8 KV / 3

Type / Cat. No.	Standard Pack
CTS95L	10
CTS95LS	10
EP4P	10
CA501-1M / CA501-1M-S	25 m
CA502 / CA702 / CA102	50
CA509/K2B4WHT	100
M10	

Type / Cat. No.	I _{max}	Standard Pack
CA798/2	220 A	10
CA798/3	220 A	10
Mounted on		
CTSPC3-1	EP4P	10
CTSPC2-3	CTSEP4	10

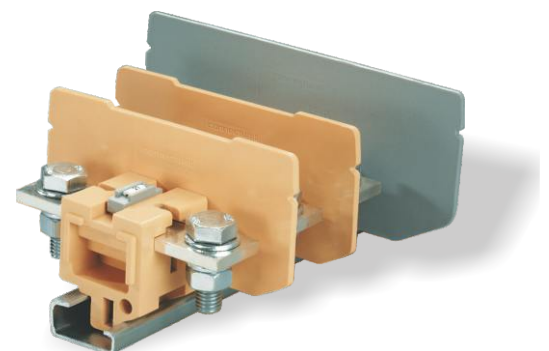

SPRING LOADED TERMINAL BLOCKS

These modified version of feed through Terminal Blocks come with safety springs. These Terminal Blocks are preferred for connections that involve safety requirements of the Electric Supply Industry (ESI) standards, British CEBG regulations and NTPC applications. In addition to the high torque screws, these blocks have a built-in spring loading feature. It is recommended to use hook type lugs for terminating wires in such connections. These Terminal Blocks have a specially designed current bar for the right location/ placement of wires with hook type lugs, thus preventing loosening of the wires even when the screw clamps are not tightened.

The housing of these Terminal Blocks is made of High Grade Melamine which has insulation properties in accordance with the CEBG regulations.

CTS4SC



Width (Thickness) x Length	6.7 x 40 mm		
Height with DIN 32 x 15 mm Rail	52.0 mm		
Connection Possibility as per	IEC	UL - CSA	
With 1 Conductor per clamp	Stranded / Flexible	0.2 - 4.0 mm ²	22 - 10 AWG
	Solid	0.2 - 6.0 mm ²	
With 2 same size Conductors per clamp	with Ferrule / Lug	0.2 - 4.0 mm ²	22 - 10 AWG
	Stranded / Flexible with TWIN Ferrule / Lug	0.2 - 2.5 mm ²	22 - 12 AWG
Wire Stripping Length	12 mm		
Ratings As Per	IEC60947-7-1 CSA22.2-158		
Voltage	600 V	300 V	
Current	32 A	35 A	
Torque	0.5 Nm	7 lb-in	
Approvals			
Insulation Material / Comparative Tracking Index	Melamine / 1		
Rated Impulse Voltage / Pollution Degree	8 KV / 3		
	Type / Cat. No.	Standard Pack	
Terminal Block	CTS4SC	200	
End Plate	CTSEP1	50	
Partition Plate	CTSPP1L CTSPP1B	50 50	
Mounting Rail (Refer Pg. 263 for details)	CA501-1M / CA501-1M-S	25 m	
End Clamp (Refer Pg. 264 for details)	CA502 / CA702	50	
Marking Tags (Refer Pg. 268 for details)	CA509/K2WHT	100	
Screw Driver	SCS0.6/3.5	Blade size: 0.6 x 3.5 mm 10	
	Type / Cat. No.	Imax	Standard Pack
Hook Type Lugs	1.5 sq.mm	CA604/1	100
	2.5 sq.mm	CA604/2	100
	6 sq.mm		
	10 sq.mm		
Screw Type Jumpers	2 pole	CA522/2	32 A 100
	3 pole	CA522/3	32 A 100
	4 pole	CA522/4	32 A 100
	10 pole	CA522/10	32 A 10
Insulated Screw Type Jumpers	2 pole	CA622/2	32 A 100
	3 pole	CA622/3	32 A 100
	4 pole	CA622/4	32 A 100
	10 pole	CA622/10	32 A 10
Jumper Bar	2 pole	CA503/1	32 A 100
	3 pole	CA504/1	32 A 100
	4 pole	CA505/1	32 A 100
	10 pole	CA510/1	32 A 100
Short Sleeve & Screw for configurable jumper bar	CA507/S/Q/1	100	
Switchable Jumpers	CA506/1	32 A	100
Long Sleeve & Screw for Switchable Jumpers	CA707/L/Q/1	100	

CTS6SC



8 x 40 mm

52.0 mm

IEC	UL - CSA
1.5 - 6.0 mm ²	22 - 8 AWG
1.5 - 6.0 mm ²	22 - 8 AWG
1.5 - 4.0 mm ²	22 - 10 AWG
1.5 - 4.0 mm ²	22 - 10 AWG

12 mm

IEC60947-7-1 CSA22.2-158

600 V	300 V		
41 A	50 A		
0.8 Nm	14 lb-in		



Melamine / 1

8 KV / 3

Type / Cat. No.	Standard Pack
CTS6SC	200
CTSEP1	50
CTSP1L	50
CTSP1B	50
CA501-1M / CA501-1M-S	25 m
CA502 / CA702	50
CA509/K2WHT	100
SCS0.8/4 Blade size: 0.8 x 4 mm	10

Type / Cat. No.	Imax	Standard Pack
CA604/1		100
CA604/2		100
CA604/3		100
CA723/2	41 A	100
CA723/3	41 A	50
CA723/4	41 A	50
CA723/10	41 A	10
CA743/2	41 A	100
CA743/3	41 A	50
CA743/4	41 A	50
CA743/10	41 A	10
CA703/2	41 A	100
CA704/2	41 A	100
CA705/2	41 A	100
CA733/10	41 A	100

CA707/S/Q/1		100
CA706/2	41 A	100
CA707/L/Q/1		100

CTS10SC



11 x 50 mm

59.5 mm

IEC	UL - CSA
1.5 - 10.0 mm ²	22 - 8 AWG
1.5 - 10.0 mm ²	22 - 8 AWG
1.5 - 6.0 mm ²	22 - 8 AWG
1.5 - 6.0 mm ²	22 - 10 AWG

12 mm

IEC60947-7-1 CSA22.2-158

800 V	300 V		
57 A	50 A		
1.2 Nm	14 lb-in		



Melamine / 1

8 KV / 3

Type / Cat. No.	Standard Pack
CTS10SC	100
CTSEP1SC	50
CTSP1SC	50
CA501-1M / CA501-1M-S	25 m
CA502 / CA702	50
CA509/K2WHT	100
SCS0.8/4 Blade size: 0.8 x 4 mm	10

Type / Cat. No.	Imax	Standard Pack
CA604/1		100
CA604/2		100
CA604/3		100
CA604/4		100
CA526/2	57 A	100
CA526/3	57 A	50
CA526/4	57 A	50
CA526/10	57 A	10
CA626/2	57 A	100
CA626/3	57 A	50
CA626/4	57 A	50
CA626/10	57 A	10
CA503/6	57 A	100
CA504/6	57 A	100
CA505/6	57 A	100
CA510/6	57 A	100

CA707/S/Q/3		100
CA506/6	57 A	100
CA707/L/Q/3		100

MULTIPOLE STRIP TERMINAL BLOCKS

The CMST series Terminal Blocks can be directly mounted on panel surfaces with the help of fixing screws. They are available from a 2 upto 12 pole configuration.

CMST2 series Terminal Blocks are an ideal choice for transformers. It has a special current bar design, enabling direct soldering of transformer wires.

The CMST terminal strip can also be fixed on the edge of transformer plates / panels with the help of FPCMST fixing plates.

Cross connection can be achieved with the aid of insulated jumpers.

FPCMST Partition plate for terminal strip

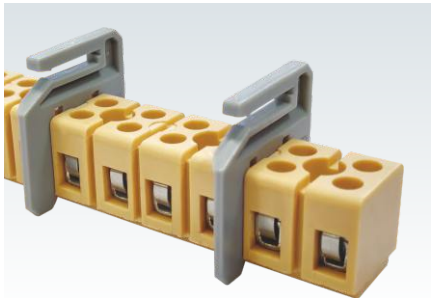

Mounting of terminal strip with panel fixing plate FPCMST

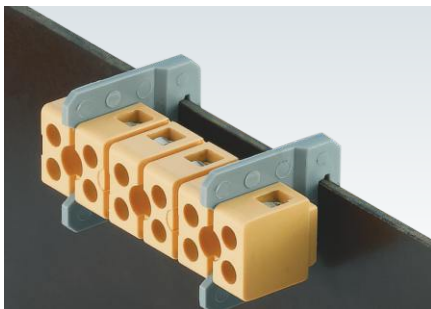

Connection Possibility as per		IEC	UL - CSA	
With 1 Conductor per clamp	Stranded / Flexible	0.2 - 2.5 mm ²	22 - 14 AWG	
	Solid with Ferrule / Lug	0.2 - 4.0 mm ²	22 - 10 AWG	
With 2 same size Conductors per clamp	Stranded / Flexible	0.2 - 2.5 mm ²	22 - 14 AWG	
	with TWIN Ferrule / Lug	0.2 - 1.5 mm ²	22 - 18 AWG	
Wire Stripping Length		9 mm		
Ratings As Per		IEC60947-7-1 CSA22.2-158		
Voltage		400 V	300 V	
Current		24 A	20 A	
Torque		0.4 Nm	4.5 lb-in	
Approvals				
Insulation Material / Comparative Tracking Index		Melamine / 1		
Rated Impulse Voltage / Pollution Degree		6 KV / 3		
		Type / Cat. No.	Length (L) mm	Standard Pack
Terminal Block	12 pole	CMST1	110	20
	2 pole	CMST12W	20	120
	3 pole	CMST13W	29	80
	4 pole	CMST14W	38	60
	5 pole	CMST15W	47	45
	6 pole	CMST16W	56	40
	7 pole	CMST17W	65	30
	8 pole	CMST18W	74	30
	9 pole	CMST19W	83	25
	10 pole	CMST110W	92	20
Panel Fixing / Partition Plate		FPCMST		50
Two pole External Jumper		CA513	Imax.: 24 A	50
Marking Strip		CA509/7		10
Markers Fixing Screw with fibre washer size M3 x 18		CA502/F		20

CMST1

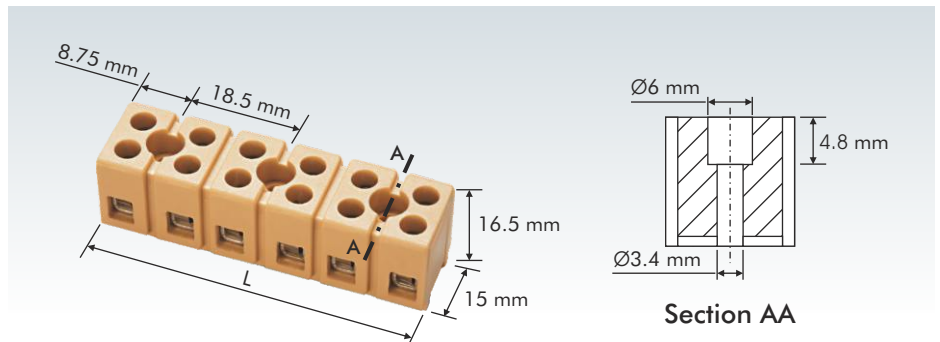
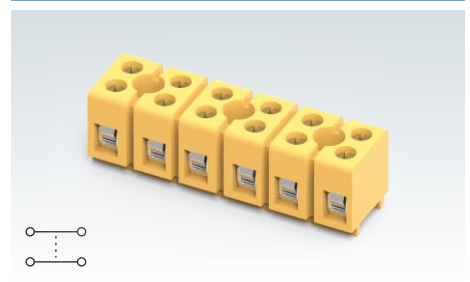

CMST2

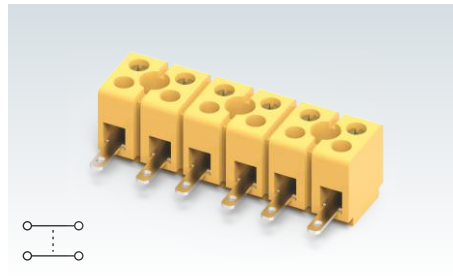

Connection Possibility as per		IEC	UL - CSA	
With 1 Conductor per clamp	Stranded / Flexible	0.2 - 2.5 mm ²	22 - 14 AWG	
	Solid with Ferrule / Lug	0.2 - 4.0 mm ² 0.2 - 2.5 mm ²	22 - 10 AWG 22 - 14 AWG	
With 2 same size Conductors per clamp	Stranded / Flexible	0.2 - 1.5 mm ²	22 - 18 AWG	
	with TWIN Ferrule / Lug	0.2 - 1.5 mm ²	22 - 18 AWG	
Wire Stripping Length		9 mm		
Ratings As Per		IEC60947-7-1 CSA22.2-158		
Voltage		400 V	300 V	
Current		24 A	20 A	
Torque		0.4 Nm	4.5 lb-in	
Approvals				
Insulation Material / Comparative Tracking Index		Melamine / 1		
Rated Impulse Voltage / Pollution Degree		6 KV / 3		
		Type / Cat. No.	Length (L) mm	Standard Pack
Terminal Block	12 pole	CMST2	110	20
	2 pole	CMST22W	20	120
	3 pole	CMST23W	29	80
	4 pole	CMST24W	38	60
	5 pole	CMST25W	47	45
	6 pole	CMST26W	56	40
	7 pole	CMST27W	65	30
	8 pole	CMST28W	74	30
	9 pole	CMST29W	83	25
	10 pole	CMST210W	92	20
Panel Fixing / Partition Plate		FPCMST		50
Two pole External Jumper		CA513	I _{max} : 24 A	50
Marking Strip		CA509/7		10
Markers Fixing Screw with fibre washer size M3 x 18		CA502/F		20

CERAMIC TERMINAL BLOCKS

These Terminal Blocks are used in extremely high temperature applications such as hot melt glue guns, furnaces, heaters, process equipment and machinery. These Ceramic Terminal Blocks have an operating temperature range of -40° to 650°C.

CB4

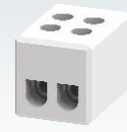

Height x Width (Thickness)	25 x 19 mm			
Connection Possibility as per	IEC	UL - CSA		
	With 1 Conductor per clamp	Stranded / Flexible	0.5 - 2.5 mm ²	24 - 12 AWG
		Solid	0.5 - 4.0 mm ²	24 - 10 AWG
		with Ferrule / Lug	0.5 - 2.5 mm ²	24 - 12 AWG
With 2 same size Conductors per clamp	Stranded / Flexible	0.5 - 1.5 mm ²	24 - 12 AWG	
	with TWIN Ferrule / Lug	0.5 - 1.5 mm ²	24 - 12 AWG	
Wire Stripping Length	8 mm			
Ratings As Per	IEC60947-7-1	UL-1059	CSA22.2-158	
Voltage	800 V	300 V	300 V	
Current	24 A	20 A	30 A	
Torque	0.4 Nm	6 lb-in	7 lb-in	
Approvals				
Insulation Material / Comparative Tracking Index	Ceramic / 1			
Rated Impulse Voltage / Pollution Degree	4 KV / 3			
No. of Poles	Type	Type / Cat. No.	Standard Pack	
1	Free Floating	CB4/1	50	
2	Free Floating	CB4/2	100	
2	With Mounting Hole	CB4/2H	50	
3	Free Floating	CB4/3	50	
3	With Mounting Hole	CB4/3H	50	
Screw Driver		SCS0.5/3 Blade size: 0.5 x 3 mm	10	

Design A

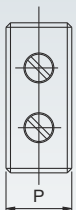

Design B

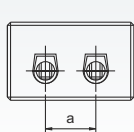
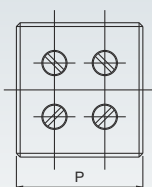

Design C

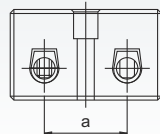
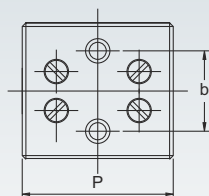

Design D

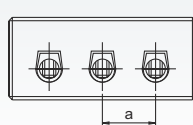
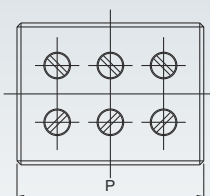

Design E

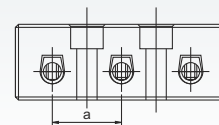
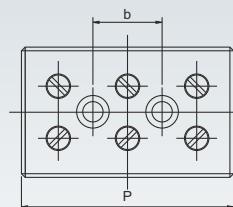

Design F

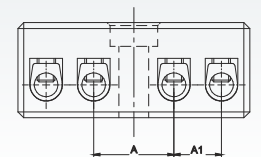
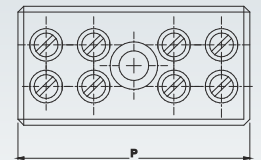

CB6



25 x 19 mm

CB16

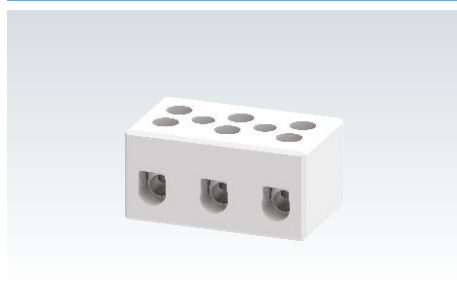

29 x 24 mm

IEC	UL - CSA
0.5 - 4.0 mm ²	22 - 10 AWG
0.5 - 6.0 mm ²	
0.5 - 4.0 mm ²	22 - 10 AWG
0.5 - 2.5 mm ²	22 - 12 AWG
0.5 - 2.5 mm ²	22 - 12 AWG

8 mm

IEC60947-7-1 UL-1059 CSA22.2-158

800 V	300 V	300 V
32 A	30 A	40 A
0.5 Nm	6 lb-in	7 lb-in



Ceramic / 1

4 KV / 3

Type / Cat. No.	Standard Pack
CB6/1	50
CB6/2H	50
CB6/3H	50
CB6/4H	50
SCS0.8/4 Blade size: 0.8 x 4 mm	10

IEC	UL - CSA
1.5 - 10.0 mm ²	18 - 6 AWG
1.5 - 10.0 mm ²	18 - 6 AWG
1.5 - 6.0 mm ²	18 - 8 AWG
1.5 - 6.0 mm ²	18 - 8 AWG

8 mm

IEC60947-7-1 UL-1059 CSA22.2-158

800 V	300 V	300 V
57 A	65 A	76 A
1.2 Nm	12 lb-in	14 lb-in

















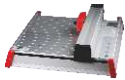

Ceramic / 1

4 KV / 3

Type / Cat. No.	Standard Pack
CB16/2H	50
CB16/3H	50
SCS0.8/4 Blade size: 0.8 x 4 mm	10

Type Cat. No.	Design Type	No. of Poles	Stripping Length	P	a	b	Fixing Screw
CB4/1	A	1	6	11	-	-	-
CB4/2	B	2	6	18	7.2	-	-
CB4/2H	C	2	6	23	13.6	14.5	M3 x 16
CB4/3	D	3	6	25	7.2	-	-
CB4/3H	E	3	6	36	13	13	M3 x 16
CB6/1	A	1	6	12	-	-	-
CB6/2H	C	2	6	26	15	12.6	M3 x 16
CB6/3H	E	3	6	41	15	15	M3 x 16
CB6/4H	F	4	8	40	13.5	-	M8 x 16
CB16/2H	C	2	8	31	17	16.5	M3 x 20
CB16/3H	E	3	8	48	17	17	M3 x 20

ACCESSORIES

	Mounting Rail	263
	End Clamp	264
	Group Marker Holder	265
	Mounting Brackets / Spacer	266
	Mounting Handle / Mounting Base	267
	Marking Tags	268 - 269
	Warning Labels / Test Plugs	270
	Marker Plotter System	271 - 272
	Screw Clamp Terminal Block Jumpers	273 - 276
	Melamine Terminal Block Jumpers	277 - 278
	Stud Type Terminal Block Jumpers	277 - 278
	CX, CSC, CY, AS Series Terminal Jumpers	279
	End Plates	280 - 281
	Partition & Separator Plates	281
	Protective Covers & Support Plate	282
	Professional Tools	283 - 285
	Sockets & Switches	287 - 288

MOUNTING RAILS

Most of Connectwell's Terminal Blocks and Interface Modules are designed to be mounted on DIN Rails (Channels) that can be fixed easily on panel boards and other equipment.

Connectwell offers three types of steel mounting rails: Din 32, Din 35 and Din 15 that comply with European standards **EN 50 0035**, **EN 50 022** and **EN 50 045** respectively. The rails are zinc plated and chromate passivated. According to the **DIN VDE 0611** part 3, steel mounting rails are permissible as grounding bus bars (**PE** function) but do not have the **PEN** function.

All mounting rails are available in standard 1m and 2 m lengths. Cut to length mounting rails with holes / slots as per customer requirement are also available on request.

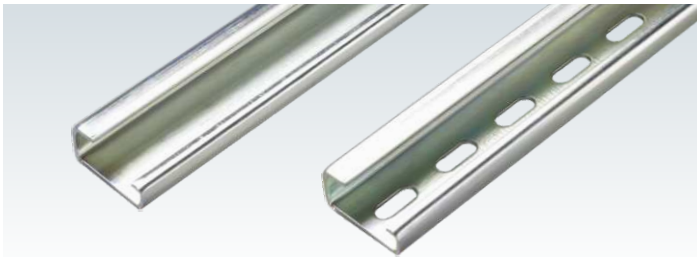

Din 32 Rail [Din 1] (32 x 15 x 1.5 mm)

Part No.	Length/Type	Standard Pack
CA501-1M	1 m, unslotted	25 m
CA501-1M-S	1 m, slotted	25 m
CA501-2M	2 m, unslotted	25 m
CA501-2M-S	2 m, slotted	25 m

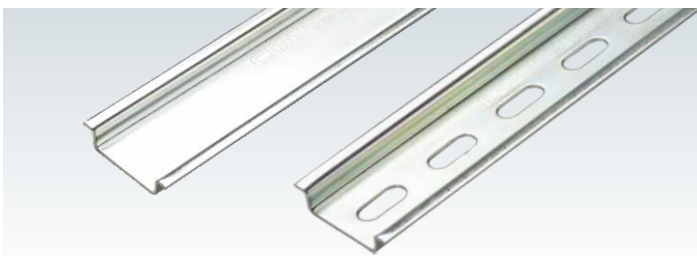

Din 35 Rail [Din 3] (35 x 7.5 x 1.0 mm)

Part No.	Length/Type	Standard Pack
CA701-1M	1 m, unslotted	50 m
CA701-1M-S	1 m, slotted	50 m
CA701-2M	2 m, unslotted	50 m
CA701-2M-S	2 m, slotted	50 m

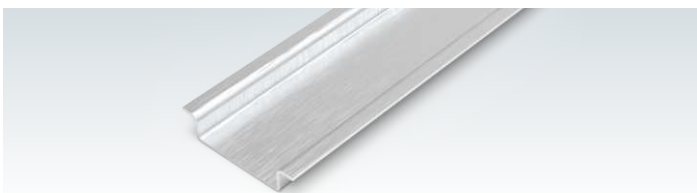

Aluminium Mounting Rails (35 x 7.5 x 1.0 mm)

Part No.	Length/Type	Standard Pack
CA701-AL-1M	1 m, unslotted	50 m

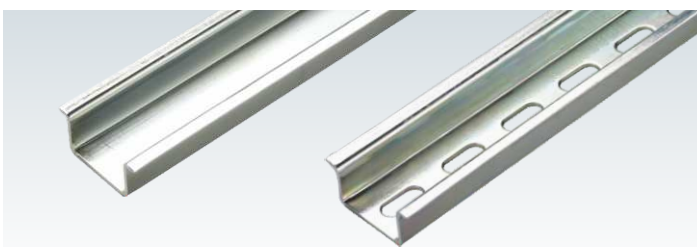

Din 35-15 Rail [Din 1] (35 x 15 x 1.5 mm)

Part No.	Length/Type	Standard Pack
CA701-15-1M	1 m, unslotted	25 m
CA701-15-1M-S	1 m, slotted	25 m
CA701-15-2M	2 m, unslotted	25 m
CA701-15-2M-S	2 m, slotted	25 m

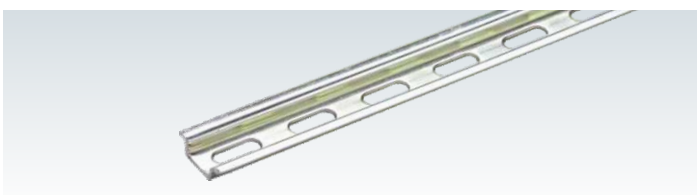

Din 15 Rail [Din 2] (15 x 5 x 1.0 mm)

Part No.	Length/Type	Standard Pack
CA601-1M	1 m, slotted	100 m







End Cap for Mounting Rails

Part No.	Length/Type	Standard Pack
ECAP35/7.5	For Din Rail 35	100
ECAP35/15	For Din Rail 35-15	100

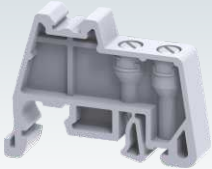
END CLAMPS

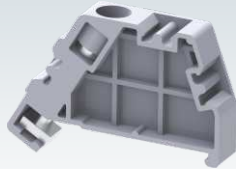
End Clamps help to secure the entire Terminal Block assembly on the DIN Rail. End Clamps should be fixed on both sides of the Terminal Block assemblies. These End Clamps are designed to fix on DIN 32, DIN 35 and DIN 15 rails. The Polyamide series End Clamps have suitable recesses to accommodate a group marker holder and marking tags for group identification. The steel parts are Zinc plated and Chromate passivated. The CA102 and CA202 are large End Clamps for heavy duty applications. CA103 is a screwless End Clamp which can be snapped on to the Din Rail.

CA702			CA102			CA802		
								
Width (Thickness) x Length	9 x 45 mm		Width (Thickness) x Length	9 x 46 mm		Width (Thickness) x Length	8 x 45 mm	
Height with DIN 35 x 7.5 mm Rail	35.75 mm		Height with DIN 35 x 7.5 mm Rail	51.40 mm		Height with DIN 35 x 7.5 mm Rail	31.30 mm	
Height with DIN 35 x 15 mm Rail	43.30 mm		Height with DIN 35 x 15 mm Rail	58.90 mm		Height with DIN 35 x 15 mm Rail	38.80 mm	
Height with DIN 32 mm Rail	36.85 mm		Height with DIN 32 mm Rail	52.50 mm				
Material	Polyamide		Material	Polyamide		Material	Polyamide	
Part No.	Suitable For	Std. Pack	Part No.	Suitable For	Std. Pack	Part No.	Suitable For	Std. Pack
CA702	DIN 32 / DIN 35 / DIN 35-15 Rail	50	CA102	DIN 32 / DIN 35 / DIN 35-15 Rail	50	CA802	DIN 35 / DIN 35-15 Rail	50

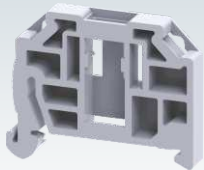
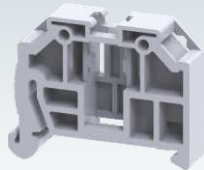
CA202			CA103			CA104		
								
Width (Thickness) x Length	9.5 x 50 mm		Width (Thickness) x Length	6 x 41 mm		Width (Thickness) x Length	10 x 41 mm	
Height with DIN 35 x 7.5 mm Rail	48.50 mm		Height with DIN 35 x 7.5 mm Rail	36.10 mm		Height with DIN 35 x 7.5 mm Rail	36.10 mm	
Height with DIN 35 x 15 mm Rail	55.80 mm		Height with DIN 35 x 15 mm Rail	43.25 mm		Height with DIN 35 x 15 mm Rail	43.25 mm	
Material	Polyamide		Material	Polyamide		Material	Polyamide	
Part No.	Suitable For	Std. Pack	Part No.	Suitable For	Std. Pack	Part No.	Suitable For	Std. Pack
CA202	DIN 35 / DIN 35-15 Rail	25	CA103	DIN 35 / DIN 35-15 Rail	50	CA104	DIN 35 / DIN 35-15 Rail	50

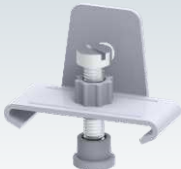
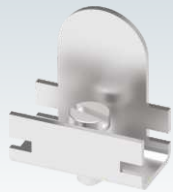
CA602			CA302 / CA402			CA502		
								
Width (Thickness) x Length	8 x 28 mm		Width (Thickness) x Length	16 x 27 mm		Width (Thickness) x Length	11.5 x 22.5 mm	
Height with DIN 15 mm Rail	21.60 mm		Height with DIN 35 x 7.5 mm Rail	29.00 mm		Height with DIN 32 mm Rail	29.20 mm	
Height with DIN 35 x 15 mm Rail			Height with DIN 35 x 15 mm Rail	37.50 mm				
Material	Polyamide		Material	Steel		Material	Steel	
Part No.	Suitable For	Std. Pack	Part No.	Suitable For	Std. Pack	Part No.	Suitable For	Std. Pack
CA602	DIN 15 Rail	50	CA302	DIN 35 Rail	50	CA502	DIN 32 Rail	50
			CA402	DIN 35-15 Rail	50			

GROUP MARKER HOLDER

Two variants of Group Marker Holders are available for identification of Terminal Block assemblies:

GMH1, GMH2, GMH3, GMH4, GMH5 and **GMH8** are to be mounted in the grooves of End Clamps.

CA509/G1 marking tag can be used with these marker holders or can be directly mounted on the end clamp.

GMH6 & GMH7 can be mounted directly on Din Rails. A sticker / paper needs to be inserted in the slot which is covered by a transparent plastic sheet.



GMH6				GMH7				GMH8 / GMH8N / GMH9			
Height x Length x Thickness (mm)		46.5 x 44.5 x 9.5		Height x Length x Thickness (mm)		46.5 x 44.5 x 19.5		Height x Length x Thickness (mm) GMH8 / GMH8N		44.65 x 31.10 x 10 / 6 mm	
Material		Polyamide 66		Material		Polyamide 66		Height x Length x Thickness (mm) GMH9		45.65 x 31.10 x 12 mm	
Material		Polyamide 66		Material		Polyamide 66		Material		Polyamide 66	
Part No.	Suitable For	Std. Pack		Part No.	Suitable For	Std. Pack		Part No.	Suitable For	Std. Pack	
GMH6	DIN 32 / DIN 35 / DIN 35-15 Rail	50		GMH7	DIN 32 / DIN 35 / DIN 35-15 Rail	50		GMH8 / GMH8N	CA103 / CA104	100	
								GMH9	CA103 / CA104	100	

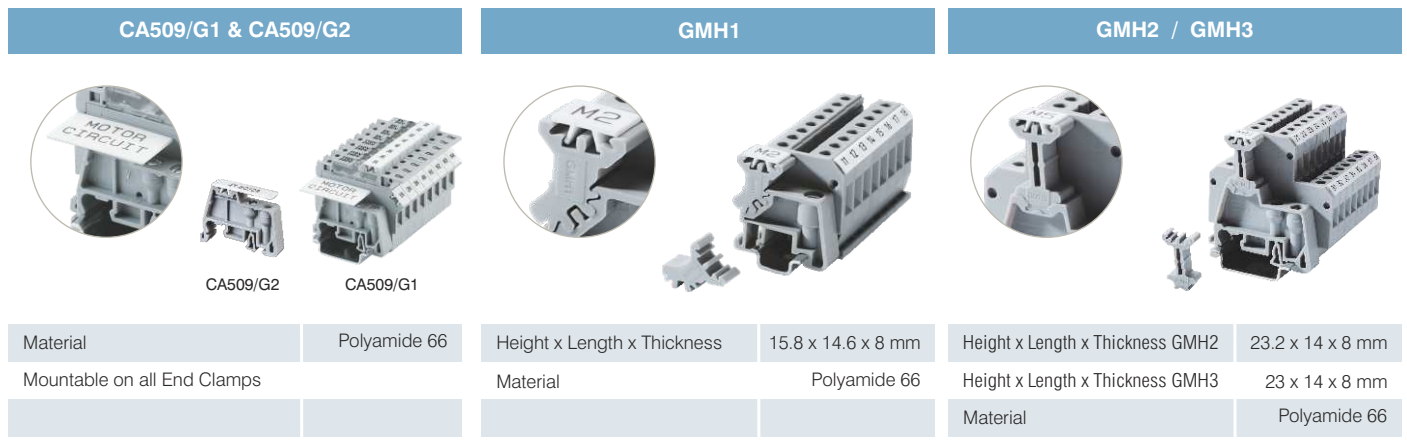

CA509/G1 & CA509/G2				GMH1				GMH2 / GMH3			
Material		Polyamide 66		Height x Length x Thickness		15.8 x 14.6 x 8 mm		Height x Length x Thickness GMH2		23.2 x 14 x 8 mm	
Mountable on all End Clamps				Material		Polyamide 66		Height x Length x Thickness GMH3		23 x 14 x 8 mm	
Material		Polyamide 66		Material		Polyamide 66		Material		Polyamide 66	
Part No.	Dimension (H x L x T)	Std. Pack	Tags	Part No.	Suitable For	Std. Pack		Part No.	Suitable For	Std. Pack	
CA509/G1	4.3 x 34 x 17.8 mm	1 Pkt	100	GMH1	CA602	100		GMH2	CA702	100	
CA509/G2	4.3 x 34 x 8 mm	1 Pkt	100					GMH3	CA802	100	



TM3.5 / TM5				GMH4				GMH5			
TM3.5 (Height x Length x Thickness)		34 x 17.8 x 3.5 mm		Height x Length x Thickness		16.2 x 14 x 8 mm		Height x Length x Thickness		13.7 x 14 x 8 mm	
TM5 (Height x Length x Thickness)		38 x 17 x 5 mm		Material		Polyamide 66		Material		Polyamide 66	
Material		Polyamide 66		Material		Polyamide 66		Material		Polyamide 66	
Part No.	Suitable For	Std. Pack		Part No.	Suitable For	Std. Pack		Part No.	Suitable For	Std. Pack	
TM3.5	CPDL Series Terminals	50		GMH4	CA802	100		GMH5	CA702	100	
TM5	CXDL Series Terminals	50									

MOUNTING BRACKETS

These are used for better access and increased clearance from the surface of the panel. These brackets are made of mild steel with zinc plating & chromate passivation.

CA603 - Can be used to install mounting rails at an angle of 45° to the panel surface.

CA703 / CA803 / CA903 - Are used for fixing mounting rails at different heights.

<table border="1"> <thead> <tr> <th>Part No.</th> <th>Std. Pack</th> </tr> </thead> <tbody> <tr> <td>CA603</td> <td>25</td> </tr> </tbody> </table>	Part No.	Std. Pack	CA603	25	<table border="1"> <thead> <tr> <th>Part No.</th> <th>Std. Pack</th> </tr> </thead> <tbody> <tr> <td>CA703</td> <td>25</td> </tr> </tbody> </table>	Part No.	Std. Pack	CA703	25	<table border="1"> <thead> <tr> <th>Part No.</th> <th>Std. Pack</th> </tr> </thead> <tbody> <tr> <td>CA803</td> <td>25</td> </tr> </tbody> </table>	Part No.	Std. Pack	CA803	25	<table border="1"> <thead> <tr> <th>Part No.</th> <th>Std. Pack</th> </tr> </thead> <tbody> <tr> <td>CA903</td> <td>25</td> </tr> </tbody> </table>	Part No.	Std. Pack	CA903	25
Part No.	Std. Pack																		
CA603	25																		
Part No.	Std. Pack																		
CA703	25																		
Part No.	Std. Pack																		
CA803	25																		
Part No.	Std. Pack																		
CA903	25																		

SPACER

CASP can be used to increase the creepage and clearance distance between the Terminal Blocks and to segregate the different groups of Terminal Blocks.

CDL4USP can be stacked with the **CDL4U(O)** Terminal Block to create a housing for discrete components or small electronic circuits.

Similarly CDL4UNSP fits the CDL4UN Terminal Block. The stacked housing can be fitted with an end plate to create a 'touch-proof' housing.

Width (Thickness) x Length	8 x 45 mm
Height with DIN 35 x 7.5 mm Rail	30.50 mm
Height with DIN 35 x 15 mm Rail	38.10 mm
Height with DIN 32 mm Rail	35.45 mm
Material	Polyamide 66

Part No.	Suitable For	Std. Pack
CASP	DIN 32 / DIN 35 / DIN 35-15 Rail	50

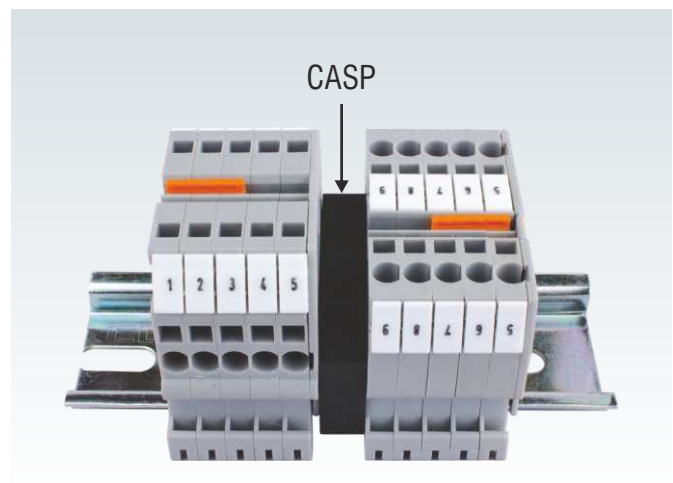

Material	Polyamide 66
----------	--------------

Part No.	Suitable For	Dimension (T x L x H)	Std. Pack
CDL4USP	CDL4U	54 x 55.5 x 6 mm	50
CDL4UNSP	CDL4UN	57 x 58 x 6 mm	50

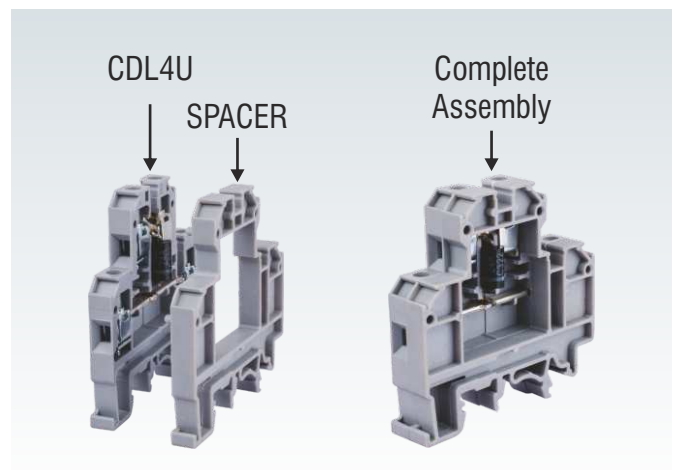

MOUNTING HANDLE

The Mounting Handle is used for easy and quick mounting of 10 Terminal Blocks on a Din Rail. The Terminal Blocks can be lifted from the packaging box with the help of this tool.



Part No.	Suitable for	Standard Pack
MH2.5	CTS2.5UN	1
MH4	CTS2.5UE / CTS4UN	1

MOUNTING BASE

CMTB35 is used to assemble components on a Din Rail. The mounting base has 4 holes of $\text{Ø} 4.3 \text{ mm}$ and 2 holes of $\text{Ø} 5.5 \text{ mm}$. CA902 can be used to fasten Din 15 Rail on to the Din 32 Rail.

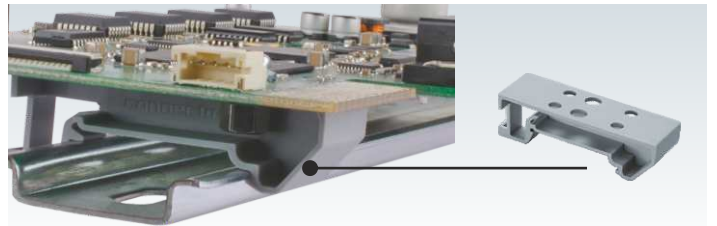
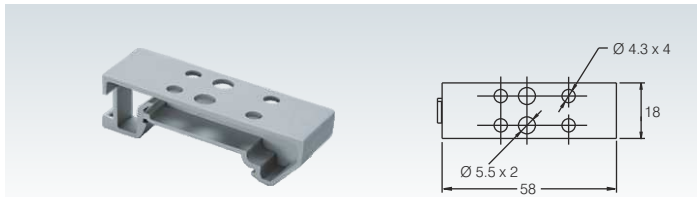

Part No.	Suitable for	Standard Pack
CMTB35	Din 35 rail mounting	50

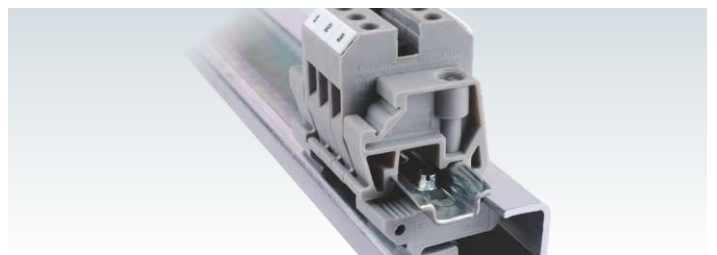
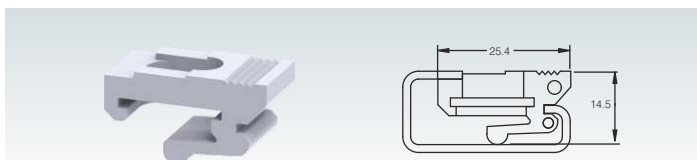

Part No.	Suitable for	Standard Pack
CA902	Din 32 rail mounting	50

SPRING CLAMP ACTUATOR TOOL

The spring clamp actuator tool can actuate two adjacent springs thereby facilitating rapid wiring.

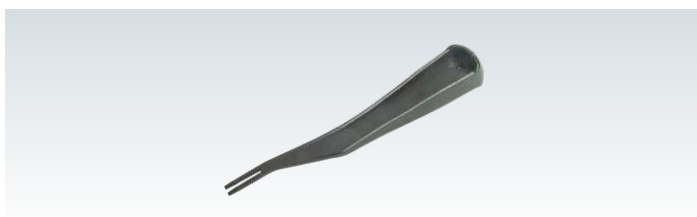

Part No.	Suitable for	Standard Pack
SCA2.5	CX2.5, CXDL2.5, CM2.5S, CXM2.5, CSCP2.5 Series Terminals	1

MARKING TAGS

'K' Series Marking Tags

The quick to fix 'K' series Marking Tags facilitate identification of Electrical circuits in a Terminal Block assembly. This in turn makes the maintenance of individual components quicker and hassle free. The tags come with a large surface area providing better visibility. All 'K' series tags are available as strips in which an individual marker can be easily separated. CA509/K6F and CA509/K9F marking tags are continuous strips of 60 mm and 90 mm length respectively. The Marking Tags are available in both printed and blank versions. The printing can be horizontal or vertical in 2 or 3 digits, alphabets or symbols or a combination of these depending on user's requirement.

For ordering pre-printed marking tags, the following pattern should be followed:

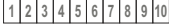
For a strip of marking tags for CTS2.5UN Terminal Blocks marked horizontally from 1 to 10: CA509/K5/H/1-10 

For a strip of marking tags for CTS4UN Terminal Blocks marked vertically with alphabet A: CA509/K6/V/A 

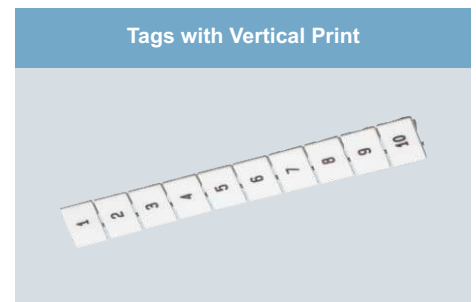
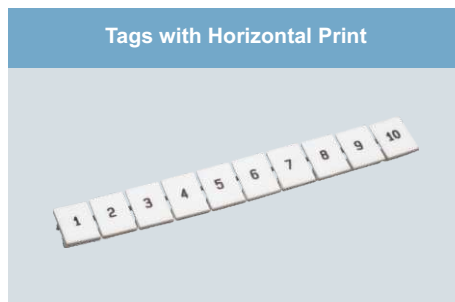
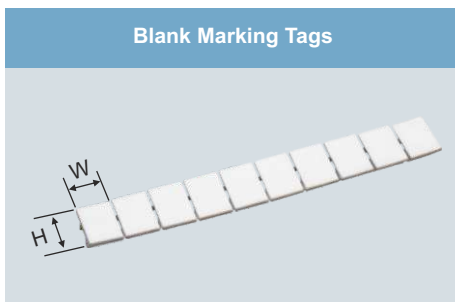

Part No.	Std. Pack		Dimensions	
	Packet	Strips	H	W
CA509/K2WHT	1	10	4.9	5.8
CA509/K3WHT	1	20	5.0	10.0
CA509/K4WHT	1	10	5.0	4.8
CA509/K5WHT	1	10	9.5	4.5
CA509/K6WHT	1	10	9.5	5.6
CA509/K6FWHT	1	10	9.5	60
CA509/K7.5WHT	1	10	5.3	7.5
CA509/K8WHT	1	10	10.5	7.5
CA509/K9WHT	1	10	10.3	8.7
CA509/K9FWHT	1	10	10.3	90.0
CA509/K10WHT	1	20	10.4	9.5
CA509/K12WHT	1	20	10.4	11.4
CA509/K16WHT	1	20	10.5	15.4
CA509/K2GWHT	1	10	5.0	5.0
CA509/K2B4WHT	1	10	5.8	9.1
CA509/K3.5WHT	1	8	9.2	3.5
MS3.5WHT	1	8	8	3.5
MS5WHT	1	10	5.0	8.0

Part No.	Std. Pack		Dimensions	
	Packet	Strips	H	W
CA509/K2/H	1	10	4.9	5.8
CA509/K3/H	1	20	5.0	10.0
CA509/K4/H	1	10	5.0	4.8
CA509/K5/H	1	10	9.5	4.5
CA509/K6/H	1	10	9.5	5.6
CA509/K6F/H	1	10	9.5	60
CA509/K7.5/H	1	10	5.3	7.5
CA509/K8/H	1	10	10.5	7.5
CA509/K9/H	1	10	10.3	8.7
CA509/K9F/H	1	10	10.3	90.0
CA509/K10/H	1	20	10.4	9.5
CA509/K12/H	1	20	10.4	11.4
CA509/K16/H	1	20	10.5	15.4
CA509/K2G/H	1	10	5.0	5.0
CA509/K2B4/H	1	10	5.8	9.1
CA509/K3.5WHT	1	8	9.2	3.5
MS3.5WHT	1	8	8	3.5
MS5WHT	1	10	5.0	8.0

Part No.	Std. Pack		Dimensions	
	Packet	Strips	H	W
CA509/K2/V	1	10	4.9	5.8
CA509/K3/V	1	20	5.0	10.0
CA509/K4/V	1	10	5.0	4.8
CA509/K5/V	1	10	9.5	4.5
CA509/K6/V	1	10	9.5	5.6
CA509/K6F/V	1	10	9.5	60
CA509/K7.5/V	1	10	5.3	7.5
CA509/K8/V	1	10	10.5	7.5
CA509/K9/V	1	10	10.3	8.7
CA509/K9F/V	1	10	10.3	90.0
CA509/K10/V	1	20	10.4	9.5
CA509/K12/V	1	20	10.4	11.4
CA509/K16/V	1	20	10.5	15.4
CA509/K2G/V	1	10	5.0	5.0
CA509/K2B4/V	1	10	5.8	9.1
CA509/K3.5WHT	1	8	9.2	3.5
MS3.5WHT	1	8	8	3.5
MS5WHT	1	10	5.0	8.0

MARKER CARDS

'MC' Series Marking Tags

The 'MC' series Markers come in card format which are easy for handling and storage. These Marker Cards are in Polycarbonate material which offers better fitment on Terminal Blocks, Markers are bright and clear white in colour. The Marker Cards are UV stabilised and are free from environmental effect which increases its shelf life. Marker Cards are printed on Laser Marker Printer which offers smudge free, non-erasable permanent marking. Printing is done by Laser etching which offers sharp, legible and life-long permanent marking.

For a strip of marker card for CTS2.5UN Terminal Blocks marked horizontally from 1 to 10: MC5/H/1-10

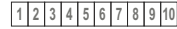

For a strip of marker card for CTS4UN Terminal Blocks marked vertically with alphabet A: MC6/V/A

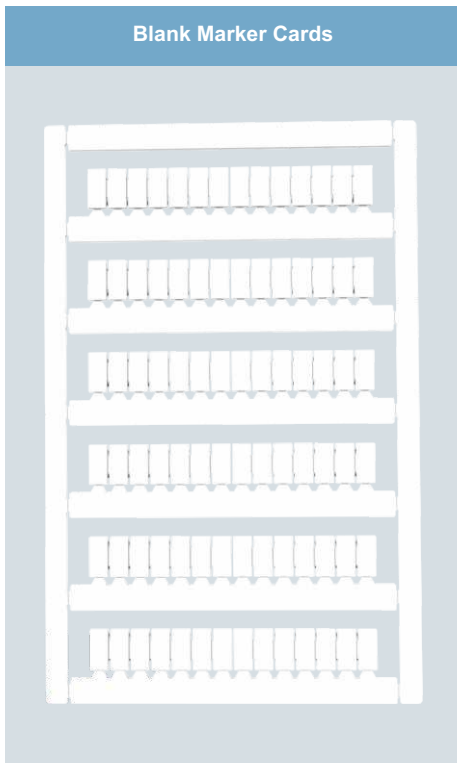

Blank Marker Cards

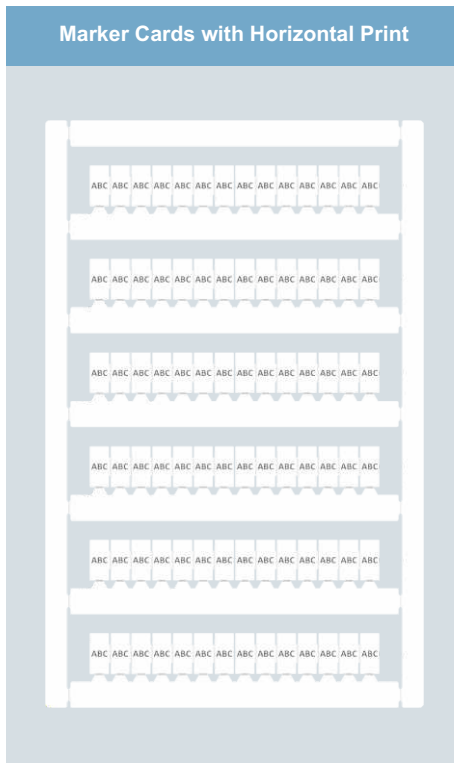

Marker Cards with Horizontal Print

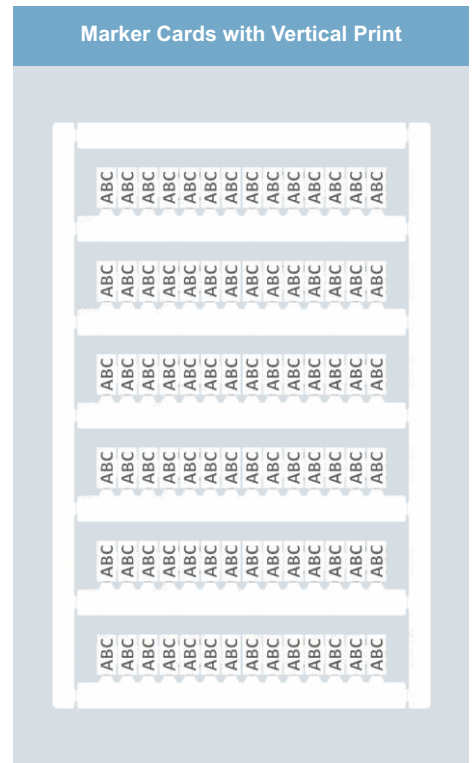

Marker Cards with Vertical Print

Part No.	Std. Pack			Dimensions	
	Packet	Rows	Tags	H	W
MC5	10	6	84	1.2	4.45
MC6	10	6	72	1.2	5.45
MC8	10	6	48	1.2	7.45
MC10	10	6	42	1.2	9.45
MC12	10	6	36	1.2	11.45
MC16	10	6	24	1.2	15.45
MC2	10	6	72	1.2	5.75
MC2B4	10	6	72	1.2	5.45
MC3.5	10	6	90	1.2	3.25

Part No.	Std. Pack			Dimensions	
	Packet	Rows	Tags	H	W
MC5/H/1-10	10	6	84	1.2	4.45
MC6/H/1-10	10	6	72	1.2	5.45
MC8/H/1-10	10	6	48	1.2	7.45
MC10/H/1-10	10	6	42	1.2	9.45
MC12/H/1-10	10	6	36	1.2	11.45
MC16/H/1-10	10	6	24	1.2	15.45
MC2/H/1-10	10	6	72	1.2	5.75
MC2B4/H/1-10	10	6	72	1.2	5.45
MC3.5/H/1-10	10	6	90	1.2	3.25

Part No.	Std. Pack			Dimensions	
	Packet	Rows	Tags	H	W
MC5/V/1-10	10	6	84	1.2	4.45
MC6/V/1-10	10	6	72	1.2	5.45
MC8/V/1-10	10	6	48	1.2	7.45
MC10/V/1-10	10	6	42	1.2	9.45
MC12/V/1-10	10	6	36	1.2	11.45
MC16/V/1-10	10	6	24	1.2	15.45
MC2/V/1-10	10	6	72	1.2	5.75
MC2B4/V/1-10	10	6	72	1.2	5.45
MC3.5/V/1-10	10	6	90	1.2	3.25

One packet consist of 10 Marker Cards

WARNING LABELS

Warning label that can be mounted on top of the Terminal Block for giving visual identification, it also makes an entire DIN Rail Terminal Block assembly completely shock proof.

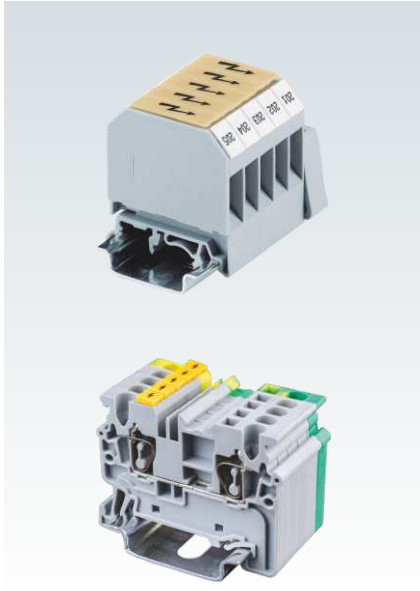
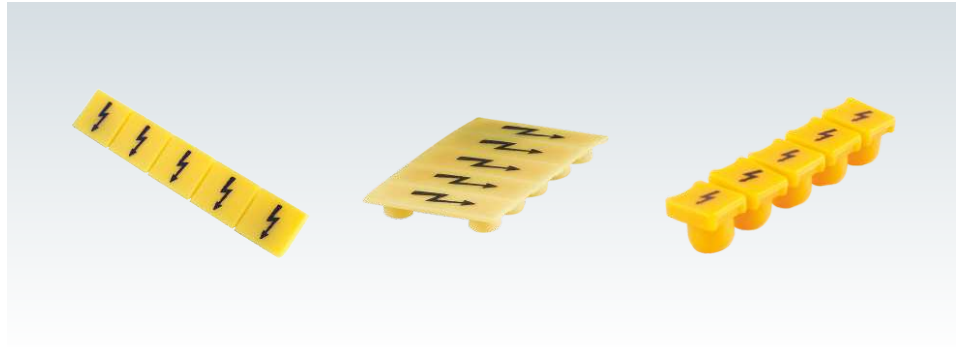

Terminal Block	Part No.	Standard Pack		
		Packet	Strips	Labels
CX2.5, CXG2.5 Series CXDL, CXDLG2.5 Series CXK2.5 Series CXM2.5, CXMG2.5	WLX2.5 WLX2.5/V (Vertical Imprint)	1	20	100
CX4, CXG4 Series CXF, CXVF Series CXK4 Series CYF, CYK, CYDLK Series	WLX4	1	20	100
CX6, CXG6 Series CXDB Series	WLX6	1	20	100
CX10, CXG10 Series	WLX10	1	20	100
CSC16T, CSCG16T	SWL16	1	20	100
CTS4UN, CTS2.5UE CDB4, CMDB4 Series	SWL4	1	20	100
CTS6U CDB6, CMDB6 Series	SWL6	1	20	100

TEST PLUGS

The Test Plugs make contact with the Jumper shaft of Terminal Block. Test adapters can be assembled with spacer to create space between two plugs & making alternate arrangement.

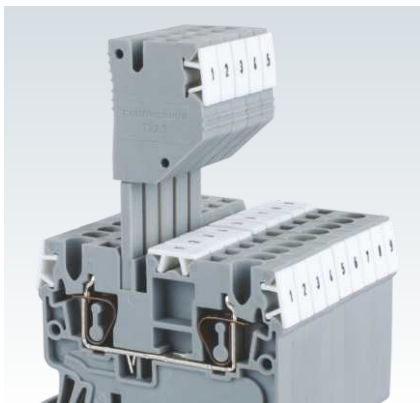

Terminal Block	Part No.	Standard Pack
CX2.5, CXG2.5 Series CXDL, CXDLG2.5 Series CXK2.5 Series CXM2.5, CXMG2.5	TX2.5	20

MARKER PLOTTER SYSTEM

CMPS600 BASIC & CMPS600

The CMPS600 BASIC and CMPS600 units are auxiliary plotters and has to be connected to a computer via a USB connection. It is a high speed plotting device and enables plotting of different markers in one setting. The marker fixture and the plotter pen have to be inserted before commencing the plotting operation. The base unit is primarily controlled through a computer with the help of CMPS software.

Dimensions for CMPS600 BASIC are 470 x 480 x 155 mm.

Dimensions for CMPS600 are 690 x 480 x 155 mm.

CMPS600 BASIC



Description	Part No.
CMPS600 BASIC, A4 Size Plotter Unit (includes cable, power adapter & software)	PL-34130098

MARKER PLOTTER & ENGRAVER ACCESSORIES

DISPOSABLE PENS

These tubular nib pens are suitable for the CMPS600BASIC and CMPS600 plotters. The disposable pens use a special ink to deliver outstanding durability and print quality with the convenience of a use and throw system. This eliminates the need for messy ink refilling and pen cleaning operation. The ink is fast drying, smudge proof, fade resistant and resistant to chemicals when used on the 'K' series Connectwell marking tags. They are available in 6 sizes differentiated by their body colour.



Tip Width	Part No.
0.18 mm	PL-35003118
0.25 mm	PL-35003125
0.35 mm	PL-35003135
0.50 mm	PL-35003150
0.70 mm	PL-35003170
1.00 mm	PL-35003200

FIXTURES

Fixtures are required for alignment of markers with respect to the plotter pen. Different marker fixtures can be mounted on the plotter bed of the CMPS600 BASIC and CMPS600 plotters at the same time thereby reducing its set up time.

The CMPS600BASIC plotter bed can accept:
 2 of the K5 fixtures or
 2 of the K2 fixtures or
 1 each of the above fixtures or
 1 of the K5 triple fixture.

The CMPS600 plotter bed can accept:
 4 of the K5 fixtures or
 4 of the K2 fixtures or
 a combination of the above two fixtures.

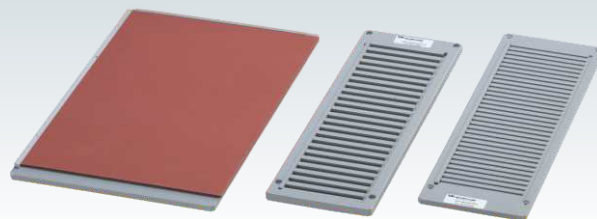

Description	For Marking Tag	Holding Capacity	Part No.
K5 Fixture	CA509/K5, K6, K8, K10, K12, K16	24 Strips	PL-34902001
K2 Fixture	CA509/K2, K3, K4, K20, K25, K2B4	24 Strips	PL-34902081
K5 Triple Fixture	CA509/K5, K6, K8, K10, K12, K16	72 Strips	PL-34130015
K9 Fixture	CA509/K9	24 Strips	PL-34902057
K2G Fixture	CA509/K2G	25 Strips	PL-34130010
Engraving Support Plate			PL-34902106

LIGHTETCH LASER MARKING SYSTEM

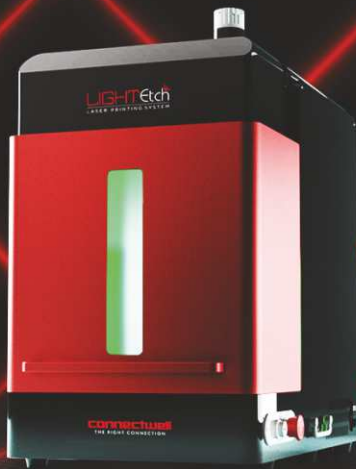

LIGHTEtch
LASER MARKING SYSTEM

THE SPEED
YOU DESIRE

THE DURABILITY
YOU DESERVE

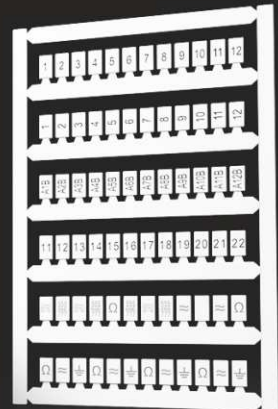

With the ever-growing and ever-changing needs of customers, the last thing on your mind should be markers for your Terminal Blocks. Connectwell's Light Etch Laser Printing System is the ultimate solution that answers all your needs. It not only prints extremely durable markers, but it also does that at the speed of light.

This Laser Marking System can become your production system's workhorse with zero consumables and no maintenance costs delivering a guaranteed life span of 10K hours of superior performance. It prints markers that are precise, consistent, and resistant to mechanical, chemical, and environmental factors.

All this, so that you may rest easy and focus on things that matter to your business.



Can print 50 characters every second



Equal to having 16 traditional plotters

Δ WORKHORSE LIKE NO OTHER



Lowest Production Cost



No Moving Parts



Zero Consumables



10K Operating Hours Guaranteed

Description	Part No.
LightEtch laser marker printer set (Includes cable, power adapter, vacuum unit, stabilizer)	CLM011

SCREW CLAMP TERMINAL BLOCK JUMPERS



Shorting / Bridging System for Polyamide Screw Clamp Terminal Blocks

The shorting systems bridge potentials between terminal blocks, reducing wiring time. Adjacent blocks or selective terminal blocks within an assembly can be easily interconnected, leaving terminal clamps free for wiring. Preassembled Jumpers, which are ready for installation, are used for quick shorting or individual components can be selected to create custom or extra long Jumpers. The current carrying capacity of shorting systems is lower than the rated current of the respective Terminal Blocks, therefore applied current must not exceed the maximum current value (IEC/EN) of the Terminal Block.

Preassembled Internal Jumpers assemblies

Internal Jumpers Assemblies consist of a Current Bar, Shorting Sleeves and screws. They install easily into the center of the terminal block and connect to the current bar. They are available as standard 2, 3, 4, 10 or 100 pole assemblies and are ready for immediate installation. Insulated preassembled internal Jumpers assemblies provide shock protection when installed on Terminal Blocks.

Insulated External Jumpers

External Jumpers bridge potentials between terminal blocks, reducing wiring time. Adjacent or selected blocks within an assembly can be easily interconnected. Individual links may be removed for selective shorting. These are insulated and available in 2, 3, 4 and 10 pole versions. They are made of tin plated brass/copper. Insulated External Link must be tightened to the recommended torque specified to get a reliable connection.

Permanent Jumpers

Jumpers are used to create custom shorting assemblies for increased number of poles. The current bar with the required number of poles can be selected, or can be cut in the field to the required length. They are made of tin or nickel plated copper or brass.

Shorting Sleeves & Screws

Shorting Sleeves & Screws ensure reliable and mechanically safe electrical connections between Jumpers and the Terminal Block current bars. One shorting sleeve is required for each shorted Terminal Block. They are made of nickel plated brass. Shorting Sleeve and Screws are supplied with spring washer. The shorting screws must be tightened to the recommended torque specified to get a reliable connection.

1 Internal shorting system not available.
2 100 pole strip can be broken down to any number of poles desired.

Terminal Series	Poles	Part No.	Torque	Std. Pack	Part No.	Torque	Std. Pack
CTS2.5UN	2	CA721/2	0.4 Nm	100	CA741/2	0.4 Nm	100
	3	CA721/3		100	CA741/3		100
	4	CA721/4		100	CA741/4		100
	10	CA721/10		10	CA741/10		10
	100 ²	CA721/100		10	CA741/100		10
CTS2.5UE CTS4UN CMC1-2 CMC2-2 CDL4UN(I.S)	2	CA722/2	0.4 Nm	100	CA742/2	0.4 Nm	100
	3	CA722/3		100	CA742/3		100
	4	CA722/4		100	CA742/4		100
	10	CA722/10		10	CA742/10		10
	100 ² 10(breakable)	CA722/100		10	CA742/100		10
CTS6U CDTTU ¹ CDTTU-SH ¹ CSDL6U ¹ CSFL6U ¹	2	CA723/2	0.5 Nm	100	CA743/2	0.5 Nm	100
	3	CA723/3		50	CA743/3		50
	4	CA723/4		50	CA743/4		50
	10	CA723/10		10	CA743/10		10
CTS10U	2	CA724/2	0.5 Nm	100	CA744/2	0.5 Nm	100
	3	CA724/3		50	CA744/3		50
	4	CA724/4		50	CA744/4		50
	10	CA724/10		10	CA744/10		10
CTS16U	2	CA751/2	0.8 Nm	50	CA761/2	0.8 Nm	50
	3	CA751/3		50	CA761/3		50
	4	CA751/4		50	CA761/4		50
	10	CA751/10		10	CA761/10		10
CTS25UN	2	CA725/2	0.8 Nm	50	CA745/2	0.8 Nm	50
	3	CA725/3		20	CA745/3		20
	4	CA725/4		20	CA745/4		20
	10	CA725/10		10	CA745/10		10
CTS35UN	2	CA771/2	0.8 Nm	50	CA781/2	0.8 Nm	50
	3	CA771/3		20	CA781/3		20
	4	CA771/4		20	CA781/4		20
	10	CA771/10		10	CA781/10		10
CMT4 CMB4 CDL4U / CDL4UN CDL4U(I.S) ODL4U CKT4U / CKT4U/4	2	CA727/2	0.4 Nm	100	CA747/2	0.4 Nm	100
	3	CA727/3		100	CA747/3		100
	4	CA727/4		100	CA747/4		100
	10	CA727/10		10	CA747/10		10
	100 ² 10(breakable)						
CSDL4U ¹ DDFL4U / 4U(E) DDDL4U	2	CA729/2	0.5 Nm	100	CA749/2	0.5 Nm	100
	3	CA729/3		50	CA749/3		50
	4	CA729/4		50	CA749/4		50
	10	CA729/10		10	CA749/10		10
CSFL4U ¹ CSFL4U(L) ¹ CF4U ¹ / CF4U(L) ¹	2						
	3						
	4						
	10						
CAFL4U ¹ CAFL4U(L) ¹	2						
	3						
	4						
	10						
CTL2.5U CTL2.5UH CTL2.5UL CTL2.5UHL CTL2.5U(I.S)	2	CA722/2	0.4 Nm	100			
	3	CA722/3		50			
	4	CA722/4		50			
	10	CA722/10		10			
	100 ² 10(breakable)	CA722/100		10			

Insulated External Jumpers



Permanent Jumpers



Shorting Sleeves & Screws



Part No.	Torque	Std. Pack
CA717/2	0.4 Nm	100
CA717/3		100
CA717/4		100
CA717/10		20
CA713/2	0.5 Nm	100
CA713/3		100
CA713/4		100
CA713/10		20
CA710/2	0.8 Nm	100
CA710/3		50
CA710/4		50
CA710/10		20
CA718/2	0.8 Nm	100
CA718/3		50
CA718/4		50
CA718/10		20
CA714/2	0.5 Nm	100
CA714/3		100
CA714/4		100
CA714/10		20
CA711/2	0.8 Nm	100
CA711/3		50
CA711/4		50
CA711/10		20
CA716/2	0.8 Nm	50
CA716/3		50
CA716/4		50
CA716/10		20
CA715/2	0.4 Nm	100
CA715/3		100
CA715/4		100
CA715/10		20

Part No.	Std. Pack
CA703/01	100
CA704/01	100
CA705/01	100
CA731/10	100
CA731/100	10
CA703/1	100
CA704/1	100
CA705/1	100
CA732/10	100
CA732/100	10
CA732/10-A	100
CA703/2	100
CA704/2	100
CA705/2	100
CA733/10	100
CA703/3	100
CA704/3	100
CA705/3	100
CA734/10	100
CA703/8	100
CA704/8	100
CA705/8	100
CA739/10	100
CA703/4	100
CA704/4	100
CA705/4	100
CA735/10	100
CA703/10	100
CA704/10	100
CA705/10	100
CA770/10	100
CA703/1	100
CA704/1	100
CA705/1	100
CA732/10	100
CA732/100	10
CA731/10-A	100
CA703/6	100
CA704/6	100
CA705/6	100
CA737/10	100
CA703/1	100
CA704/1	100
CA705/1	100
CA732/10	100
CA732/100	10
CA732/10-A	100

Part No.	Torque	Std. Pack
CA707/S/Q/01	0.4 Nm	100
CA707/S/Q/01	0.4 Nm	100
CA707/S/Q/1	0.5 Nm	100
CA707/S/Q/1	0.5 Nm	100
CA707/S/Q/1	0.5 Nm	100
CA707/S/Q/1	0.8 Nm	100
CA707/S/Q/2	0.8 Nm	100
CA707/S/Q/2	0.8 Nm	100
CA607/S/Q	0.4 Nm	100
CA707/S/Q/3	0.5 Nm	100
CA707/S/Q/01	0.4 Nm	100

SCREW CLAMP TERMINAL BLOCK JUMPERS

Pre Assembled Jumpers



Insulated Pre Assembled Jumpers



Shorting / Bridging System for Polyamide Screw Clamp Terminal Blocks

The shorting systems bridge potentials between terminal blocks, reducing wiring time. Adjacent blocks or selective terminal blocks within an assembly can be easily interconnected, leaving terminal clamps free for wiring. Preassembled Jumpers, which are ready for installation, are used for quick shorting or individual components can be selected to create custom or extra long Jumpers. The current carrying capacity of shorting systems is lower than the rated current of the respective Terminal Blocks, therefore applied current must not exceed the maximum current value (IEC/EN) of the Terminal Block.

Preassembled Internal Jumpers assemblies

Internal Jumpers Assemblies consist of a Current Bar, Shorting Sleeves and screws. They install easily into the center of the terminal block and connect to the current bar. They are available as standard 2, 3, 4, 10 or 100 pole assemblies and are ready for immediate installation. Insulated preassembled internal Jumpers assemblies provide shock protection when installed on Terminal Blocks.

Insulated External Jumpers

External Jumpers bridge potentials between terminal blocks, reducing wiring time. Adjacent or selected blocks within an assembly can be easily interconnected. Individual links may be removed for selective shorting. These are insulated and available in 2, 3, 4 and 10 pole versions. They are made of tin plated brass/copper. Insulated External Link must be tightened to the recommended torque specified to get a reliable connection.

Permanent Jumpers

Jumpers are used to create custom shorting assemblies for increased number of poles. The current bar with the required number of poles can be selected, or can be cut in the field to the required length. They are made of tin or nickel plated copper or brass.

Shorting Sleeves & Screws

Shorting Sleeves & Screws ensure reliable and mechanically safe electrical connections between Jumpers and the Terminal Block current bars. One shorting sleeve is required for each shorted Terminal Block. They are made of nickel plated brass. Shorting Sleeve and Screws are supplied with spring washer. The shorting screws must be tightened to the recommended torque specified to get a reliable connection.

Terminal Series	Poles	Part No.	Torque	Std. Pack	Part No.	Torque	Std. Pack
CTS4USC CHV4U	2	CA623/2	0.4 Nm	100	CA643/2	0.4 Nm	100
	3	CA623/3		100	CA643/3		100
	4	CA623/4		100	CA643/4		100
	10	CA623/10		10	CA643/10		10
CTS6USC CHV6U	2	CA624/2	0.5 Nm	100	CA644/2	0.5 Nm	100
	3	CA624/3		50	CA644/3		50
	4	CA624/4		50	CA644/4		50
	10	CA624/10		10	CA644/10		10
CTS10USC CHV10U	2	CA625/2	0.5 Nm	100	CA645/2	0.5 Nm	100
	3	CA625/3		50	CA645/3		50
	4	CA625/4		50	CA645/4		50
	10	CA625/10		10	CA645/10		10
CDGL2.5 CTGL2.5	2	CA627/2	0.4 Nm	100			
	3	CA627/3		100			
	4	CA627/4		100			
	10	CA627/10		10			
PTB35/50 PTB35/50SH (Bolt type Shorting System)	2	CA703/9	3.0 Nm	10			
	3	CA704/9		10			
	4	CA705/9		10			
PTB70/95 PTB70/95SH (Bolt type Shorting System)	2	CA703/11	6.0 Nm	10			
	3	CA704/11		10			
	4	CA705/11		10			
CTS50/70N CTS50/70NA	2	CA628/2	3.0 Nm	10			
	3	CA628/3		10			
CTS95/120N	2	CA629/2	6.0 Nm	10			
	3	CA629/3		10			
CSB3U/N3U CSB3/N3UL CSB3U	2	CA728/2	0.4 Nm	100			
	3	CA728/3		100			
	4	CA728/4		100			
	10	CA728/10		10			
CBS4U CSB4/N4U CBS5U CSB5/N5U	2	CA772/2	0.4 Nm	100			
	3	CA772/3		100			
	4	CA772/4		100			
	10	CA772/10		10			
STH3	2	CA773/2	0.4 Nm	100			
	3	CA773/3		100			
	4	CA773/4		100			
	10	CA773/10		10			
STH6	2	CA774/2	0.4 Nm	100			
	3	CA774/3		100			
	4	CA774/4		100			



Part No.	Torque	Std. Pack
----------	--------	-----------

Part No.	Torque	Std. Pack
----------	--------	-----------

Part No.	Torque	Std. Pack
----------	--------	-----------

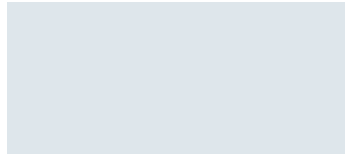
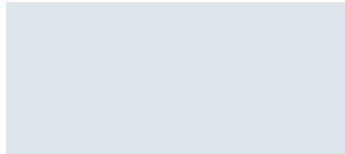
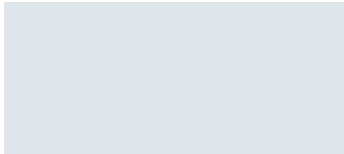

CA715/2	0.4 Nm	100
CA715/3		100
CA715/4		100
CA715/10		20

CA703/1		100
CA704/1		100
CA705/1		100
CA732/10		100

CA611/S/Q	0.4 Nm	100
-----------	--------	-----

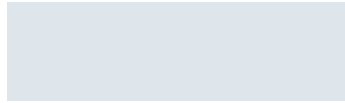
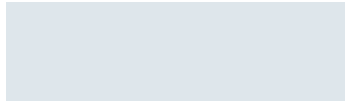
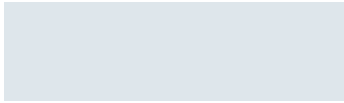
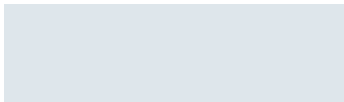
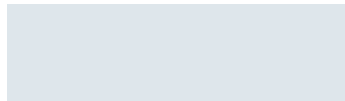
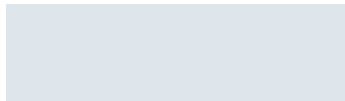
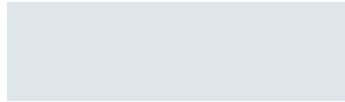
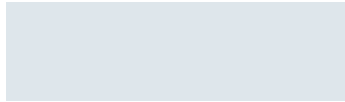
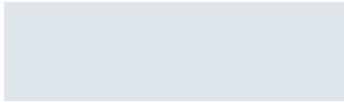

MELAMINE TERMINAL BLOCK JUMPERS

Preassembled Internal Jumpers assemblies

Internal Jumpers Assemblies consist of a Current Bar, Shorting Sleeves and screws. They install easily into the center of the Terminal Block and connect to the current bar. They are available as standard 2, 3, 4, 10 or 100 pole assemblies and are ready for immediate installation. Preassembled Insulated internal Jumpers assemblies provide shock protection when installed on Terminal Blocks.

Permanent Jumpers

These are used to create custom shorting assemblies for increased number of poles. The current bar with the required number of poles can be selected, or can be cut in the field to the required length. They are made of tin or nickel plated copper or brass.

Shorting Sleeves & Screws

Shorting Sleeves & Screws ensure reliable and mechanically safe electrical connections between Jumpers and the Terminal Block current bars. One shorting sleeve is required for each shorted Terminal Block. They are made of nickel plated brass.

Switchable Jumpers and Long Shorting Sleeves for temporary shorting

These links are used for switchable cross connection of adjacent Terminal Blocks of the same size. They can be used only in conjunction with the Long Shorting Sleeves and Screws.

STUD TYPE TERMINAL BLOCK JUMPERS

Shorting / Bridging System for Stud type Terminal Blocks

Fork Type Jumpers

These links have a possibility of quick insertion and removal. The entire nut assembly of the Terminal Block need not be removed for the insertion or removal of these links. They are available in standard 2, 3 or 4 pole configurations. They are also available in an insulated version which provides shock protection when installed on Terminal Blocks.

Ring Type Jumpers

These links provide a secure, permanent shorting possibility for stud type Terminal Blocks. They are available in standard 2, 3 or 4 pole configurations. They are also available in an insulated version which provides shock protection when installed on Terminal Blocks.

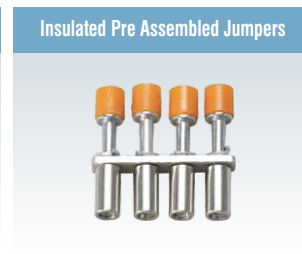

Terminal Series	Poles	Part No.	Torque	Std. Pack	Part No.	Torque	Std. Pack
CTS2.5(M)	2	CA521/2	0.4 Nm	100	CA621/2	0.4 Nm	100
	3	CA521/3		100	CA621/3		100
	4	CA521/4		100	CA621/4		100
	10	CA521/10		10	CA621/10		10
CTS2.5 CTS4SC	2	CA522/2	0.4 Nm	100	CA622/2	0.4 Nm	100
	3	CA522/3		100	CA622/3		100
	4	CA522/4		100	CA622/4		100
	10	CA522/10		10	CA622/10		10
CTS6 CTS6SC	2	CA723/2	0.5 Nm	100	CA743/2	0.5 Nm	100
	3	CA723/3		50	CA743/3		50
	4	CA723/4		50	CA743/4		50
	10	CA723/10		10	CA743/10		10
CTS10	2	CA724/2	0.5 Nm	100	CA744/2	0.5 Nm	100
	3	CA724/3		50	CA744/3		50
	4	CA724/4		50	CA744/4		50
	10	CA724/10		10	CA744/10		10
CTS16	2	CA751/2	0.8 Nm	50	CA761/2	0.8 Nm	50
	3	CA751/3		50	CA761/3		50
	4	CA751/4		50	CA761/4		50
	10	CA751/10		10	CA761/10		10
CTS35	2						
	3						
	4						
	10						

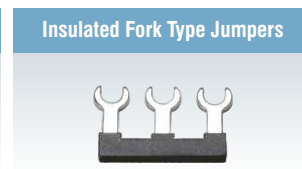
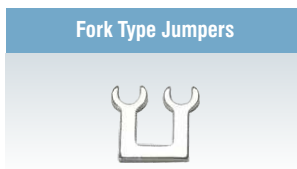

Terminal Series	Poles	Part No.	Torque	Std. Pack	Part No.	Torque	Std. Pack
CSTSB3	2	CA512/5-2	0.5 Nm	100	CA514/5-2	0.5 Nm	100
	3	CA512/5-3		50	CA514/5-3		50
	4	CA512/5-4		50	CA514/5-4		50
CSTSB4 / CSTSB5 CSTSB4/N4 CMDT4 / CMDT4SH	2	CA512/2-2	1.2 Nm	100	CA514/2-2	1.2 Nm	100
	3	CA512/2-3		50	CA514/2-3		50
	4	CA512/2-4		50	CA514/2-4		50
CSTSN4/N5 CSTSN4U/N5U CSTSB4U/B5U CBS4U/CSB4/N4U CBS5U/CSB5/N5U	2	CA512/1-2	1.2 Nm	100	CA514/1-2	1.2 Nm	100
	3	CA512/1-3		50	CA514/1-3		50
	4	CA512/1-4		50	CA514/1-4		50
	2	CA512/7-2	1.2 Nm	100	CA514/7-2	1.2 Nm	100
CSTSN6 CSTSN6U	3	CA512/7-3		50	CA514/7-3		50
	4	CA512/7-4		50	CA514/7-4		50
	2	CA512/9-2	1.2 Nm	100	CA514/9-2	1.2 Nm	100
CSTSN4(15) CSTSN5(15)	3	CA512/9-3		50	CA514/9-3		50
	4	CA512/9-4		50	CA514/9-4		50
CSTSRN5/RN6	2	CA512/11-2	1.2 Nm	50	CA514/11-2	1.2 Nm	50
STH4 STH4DT STH4DTSH	2	CA512/13-2	1.2 Nm	100	CA514/13-2	1.2 Nm	100
	3	CA512/13-3		50	CA514/13-3		50
	4	CA512/13-4		50	CA514/13-4		50
	10						
STH3/CSB3/ N3U CSB3U	2	CA512/15-2	0.5 Nm	100	CA514/15-2	0.5 Nm	100
	3	CA512/15-3		50	CA514/15-3		50
	4	CA512/15-4		50	CA514/15-4		50



Part No.	Std. Pack.
CA503/01	100
CA504/01	100
CA505/01	100
CA510/01	100

Part No.	Torque	Std. Pack.
CA507/S/Q/01	0.4 Nm	100

Part No.	Std. Pack.
CA506/01	100

Part No.	Torque	Std. Pack.
CA507/L/Q/01	0.4 Nm	100

CA503/1	100
CA504/1	100
CA505/1	100
CA510/1	100

CA707/S/Q/1	0.4 Nm	100
-------------	--------	-----

CA506/1	100
---------	-----

CA707/L/Q/1	0.4 Nm	100
-------------	--------	-----

CA703/2	100
CA704/2	100
CA705/2	100
CA733/10	100

CA707/S/Q/1	0.5 Nm	100
-------------	--------	-----

CA706/2	100
---------	-----

CA707/L/Q/1	0.5 Nm	100
-------------	--------	-----

CA703/3	100
CA704/3	100
CA705/3	100
CA734/10	100

CA707/S/Q/1	0.5 Nm	100
-------------	--------	-----

CA706/3	100
---------	-----

CA707/L/Q/1	0.5 Nm	100
-------------	--------	-----

CA703/8	100
CA704/8	100
CA705/8	100
CA739/10	100

CA707/S/Q/1	0.8 Nm	100
-------------	--------	-----

CA706/8	100
---------	-----

CA707/L/Q/1	0.8 Nm	100
-------------	--------	-----

CA503/5	100
CA504/5	100
CA505/5	100
CA510/5	100

CA508/S/Q	0.8 Nm	100
-----------	--------	-----

CA506/5	100
---------	-----

CA508/L/Q	0.8 Nm	100
-----------	--------	-----

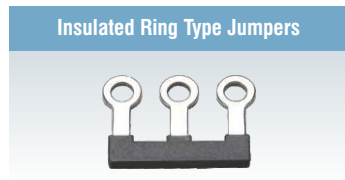

Part No.	Torque	Std. Pack.
CA512/6-2	0.5 Nm	100
CA512/6-3		50
CA512/6-4		50

Part No.	Torque	Std. Pack.
CA514/6-2	0.5 Nm	100
CA514/6-3		50
CA514/6-4		50

Part No.	Torque	Std. Pack.

CA512/4-2	1.2 Nm	100
CA512/4-3		50
CA512/4-4		50

CA514/4-2	1.2 Nm	100
CA514/4-3		50
CA514/4-4		50

--	--	--

CA512/3-2	1.2 Nm	100
CA512/3-3		50
CA512/3-4		50

CA514/3-2	1.2 Nm	100
CA514/3-3		50
CA514/3-4		50

--	--	--

CA512/8-2	1.2 Nm	100
CA512/8-3		50
CA512/8-4		50

CA514/8-2	1.2 Nm	100
CA514/8-3		50
CA514/8-4		50

--	--	--

CA512/10-2	1.2 Nm	100
CA512/10-3		50
CA512/10-4		50

CA514/10-2	1.2 Nm	100
CA514/10-3		50
CA514/10-4		50

--	--	--

CA512/12-2	1.2 Nm	50
------------	--------	----

CA514/12-2	1.2 Nm	50
------------	--------	----

--	--	--

CA512/14-2	1.2 Nm	100
CA512/14-3		50
CA512/14-4		50

CA514/14-2	1.2 Nm	100
CA514/14-3		50
CA514/14-4		50
CA514/14-10		50

CA514/14-3A	1.2 Nm	10
CA514/14-4A		10

CA512/17-2	0.5 Nm	100
CA512/17-3		50
CA512/17-4		50

CA514/17-2	0.5 Nm	100
CA514/17-3		50
CA514/17-4		50

--	--	--

CP, CX, CY SERIES TERMINAL BLOCK JUMPERS



The possibility of using 2 independent rows for bridging enables the creation of various circuit combinations. Jumpers can be marked with a felt tip pen on the recess provided on top, to clearly indicate shorted positions.

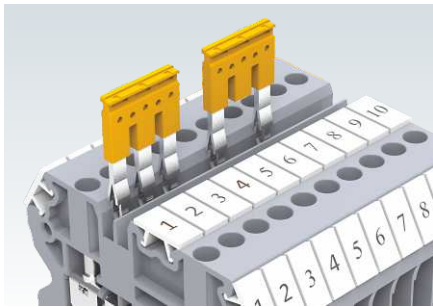

Individual Terminal Blocks in an assembly can be skipped from getting shorted with the adjacent terminal. This is achieved by breaking intermediate contacts from the standard jumpers.

STEP DOWN JUMPERS

These jumpers help in shorting Spring Clamp & Push-In Terminal Blocks of different sizes. CA801/8 and JXS Jumpers are used for shorting adjacent Terminal Blocks of different series.

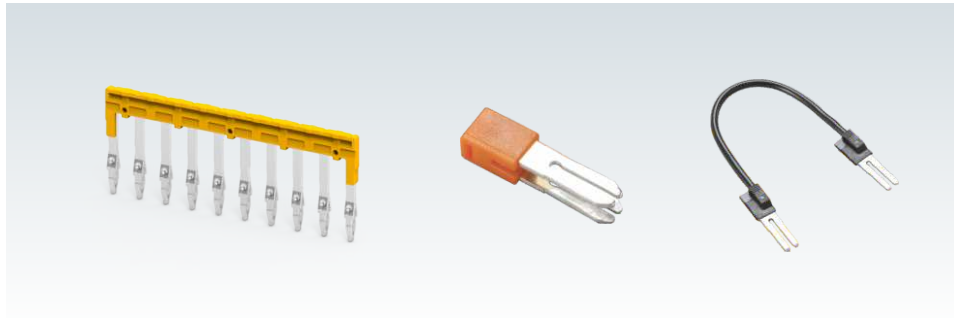

Terminal Block		Part No.	I _{max}	Std. Pack.	
CP1.5 Series CPST1.5 Series	2 pole	JX1.5/2	16 A	100	
	3 pole	JX1.5/3	16 A	50	
	4 pole	JX1.5/4	16 A	50	
	10 pole	JX1.5/10	16 A	10	
CP2.5 Series CX2.5 Series CY2.5 Series	2 pole	JX2.5/2	24 A	100	
	3 pole	JX2.5/3	24 A	50	
	4 pole	JX2.5/4	24 A	50	
	5 pole	JX2.5/5	24 A	50	
	6 pole	JX2.5/6	24 A	10	
	7 pole	JX2.5/7	24 A	10	
CP4 Series CX4 Series CY4 Series	8 pole	JX2.5/8	24 A	10	
	10 pole	JX2.5/10	24 A	10	
	2 pole	JX4/2	32 A	100	
	3 pole	JX4/3	32 A	50	
	4 pole	JX4/4	32 A	50	
	5 pole	JX4/5	32 A	50	
	6 pole	JX4/6	32 A	50	
	8 pole	JX4/8	32 A	10	
CP6/10 Series CX6 Series CXDB Series	10 pole	JX4/10	32 A	10	
	16 pole	JX4/16	32 A	10	
	2 pole	JX6/2	41 A	100	
	3 pole	JX6/3	41 A	50	
	4 pole	JX6/4	41 A	50	
	10 pole	JX6/10	41 A	10	
	CY6, CYG6 Series	2 pole	JY6/2	41 A	100
		3 pole	JY6/3	41 A	50
4 pole		JY6/4	41 A	50	
5 pole		JY6/5	41 A	50	
6 pole		JY6/6	41 A	50	
7 pole		JY6/7	41 A	10	
8 pole		JY6/8	41 A	10	
CX10, CXG10 Series	10 pole	JY6/10	41 A	10	
	2 Pole	JX10/2	57 A	20	
CY10, CYG10 Series	2 Pole	JY10/2	76 A	20	
	2 Pole	JY16/2	76 A	20	
CSC16T, CSC16/3T, CX35	2 Pole	CA801/5	76 A	100	
CSCP2.5T Series	2 Pole	CA803/1	24 A	100	
AS2.5 Series	2 Pole Adjacent	CA801/1	24 A	100	
	2 Pole Alternate	CA801/1-3	24 A	100	
	2 Pole Wire Type	CA901/1	17.5 A	100	
AS4 Series	2 Pole Adjacent	CA801/2	20 A	100	
	2 Pole Alternate	CA801/2-3	20 A	100	
	2 Pole Wire Type	CA901/2	17.5 A	100	
AS6 Series	2 Pole Adjacent	CA801/3	35 A	100	
	2 Pole Alternate	CA801/3-3	30 A	100	
	2 Pole Wire Type	CA901/3	30 A	100	

Terminal Block	Part No.	I _{max}	Std. Pack.
CX4/CP4 to CX2.5/CP2.5 Series Terminals	JXS4/2.5	24 A	50
CX6/CP6/10 to CX2.5/CP2.5 Series Terminals	JXS6/2.5	24 A	50
CX6/CP6/10 to CX4/CP4 Series Terminals	JXS6/4	32 A	50
CX10 to CX2.5 Series Terminals	JXS10/2.5	24 A	50
CSC16T to CX2.5 Series Terminals	JXS16/2.5	24 A	50
CX10 to CX6 Series Terminals	JXS10/6	24 A	50
AS6 Series to AS2.5 Series	CA801/8	24 A	100
AS6 Series to AS4 Series (Wire Type)	CA901/4	30 A	100
AS6 Series to AS2.5 Series (Wire Type)	CA901/5	24 A	100

END PLATES

End Plates are used to cover the live parts of the last Terminal Block. They should be used at the end of an assembly of identical Terminal Blocks and whenever is changed in physical size of the Terminal Block.

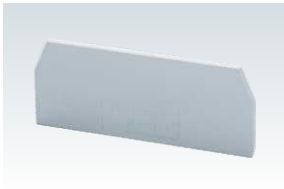

Part No.	Std. Pack	Dimension (H x W x T)	Suitable for
EP2.5/4UN	50	32 x 39 x 1.5	CTS2.5UN/2.5UE/4UN/CTT2.5UK/T/J/E
EP6/10U	50	31 x 42.5 x 1.5	CTS6U/CTS10U
EPCMC1-2	50	35.5 x 46.5 x 2.5	CMC1-2
EPCMC2-2	50	40.5 x 65 x 2.5	CMC2-2
EPCDL4UN	50	47.5 x 57 x 1.5	CDL4UN/CDL4UN(I.S)
EPODL4U	50	49 x 68 x 5.5	ODL4U/ODL4UA(Front Side)
EP1ODL4U	50	24 x 68 x 3	ODL4U/ODL4UA(Back Side)
EPODL2.5	50	55 x 59 x 4.6	ODL2.5 Series
EP1ODL2.5	50	24 x 59 x 2.5	ODL2.5 Series
EPCDGL2.5	50	48 x 71.4 x 1.2	CDGL2.5
EPCTL2.5U	50	55.5 x 84 x 1.5	CTL2.5U/2.5UL/2.5U(I.S)
EPCTL2.5UH	50	55.5 x 61 x 1.5	CTL2.5UH/2.5UH(L)/2.5UH(I.S)D2
EPCTLG2.5	50	62.5 x 87.5 x 1.2	CTGL2.5/CTGL2.5(E)MOV
EPCMT4	50	23 x 27 x 1.5	CMT4
EPCMT10	50	26.9 x 33.5 x 2.5	CMT10
EPCMB4	50	27 x 27 x 7	CMB4
EPCBS3U	50	26.2 x 49 x 1.5	CBS & CSB Series
EPCAFL4U	25	32 x 72 x 1.5	CAFL4U/4UL/4UN
EPDDL4U	25	49 x 87.6 x 3	DDFL4U/4ULR/4U(E)/4U(E)LR
EPCDTTU	50	41 x 63 x 3	CDTTU/CDTTUSH
EPCKT4U	50	30.5 x 46.5 x 2.5	CKT4U
EPCKT4U/4	50	65 x 38.3 x 1.5	CKT4U/4
EPCDS6U	50	37.2 x 82 x 1.5	CDS6U/6UTS/6UFT/6USC
EPCGT4U	50	40.5 x 43 x 1	CGT4U
EPUSC	50	52 x 48.5 x 1.5	CTS4USC/6USC/10USC/CHV4U/6U/10U
EPCTC4U	50	34.5 x 47 x 2.5	CTC4U
EPCSTSU	50	31 x 50 x 1.5	CSTSN4U/N5U/N6U/B4U/B5U
EPSTH3	50	34.4 x 47 x 1.5	STH3
EPSTH4	50	39.5 x 46 x 1.5	STH4
EPSTH6	50	51 x 63.5 x 2	STH6
EPSTH4DT	50	37.5 x 86 x 1.5	STH4DT / STH4DTS
EPCSC16T	50	82 x 38 x 1.5	CSC16T/CSCG16T
EPCSCP2.5T(L&R)	50	27.3 x 35 x 5	CSCP2.5T/CSCP2.5T2
EPAS2.5	50	35 x 54 x 1.5	AS2.5, 2.5/3, 2.5/4, AGT2.5, 2.5/3, 2.5/4
EPAS4	50	27.5 x 61 x 1.5	AS4, 4/3, 4/4, AGT4, 4/3, 4/4
EPAS6	50	33.5 x 74 x 1.5	AS6, 6/3, AGT6, 6/3
CTSEP1	50	49 x 40 x 2.7	CTS2.5/6/10/4SC/6SC
CTSEP2	50	54 x 49.5 x 3	CTS16
CTSEP3	25	52 x 58 x 2.7	CTS35
CTSEP1SC	50	43.5 x 50 x 2.5	CTS10SC
CSTSEP2	50	44.5 x 50 x 3	CSTSB3/B4/B5/N4/N5/N4(15)/N5(15)/N6
CSTSRP	50	48.5 x 43 x 3	CSTSRN5/CSTSRN6
EPCMDT4	50	48.7 x 68 x 2.4	CMDT4/CMDT4SH
EPCX2.5	50	30.5 x 49.7 x 1.5	CX2.5 / CXG2.5
EPCX2.5/3	50	30.5 x 62.2 x 1.5	CX2.5/3 / CXG2.5/3 / CXK2.5 / CPK2.5
EPCX2.5/4	50	30.5 x 74.7 x 1.5	CX2.5/4 / CXG2.5/4 CXK2.5/4 / CX2.5/4P
EPCX4	50	30.5 x 54.8 x 1.5	CX 4 / CXG4
EPCX4/3	50	30.5 x 70.5 x 1.5	CX4/3 / CXG4/3 / CXK4
EPCX4/4	50	30.5 x 86.2 x 1.5	CX4/4 / CXG4/4 / CXK4/4
EPCX6	50	35.3 x 62.1 x 1.5	CX6 / CXG6
EPCX6/3	50	35.3 x 82.2 x 1.5	CX6/3 / CXG6/3
EPCX10	50	41.6 x 70 x 1.5	CX10 / CXG10
EPCX10/3	50	41.6 x 95.3 x 1.5	CX10/3 / CXG10/3
EPCXDL2.5	50	41.8 x 72.7 x 1.5	CXDL2.5 Series
EPCXDL2.5/3	50		CXDL2.5/3 Series
EPCXS2.5	50	35.6 x 43 x 1.5	CXS2.5 / CXSG2.5 / CXS4 / CXSG4
EPCXS6	50		CXS6 Series
EPCXS10	50		CXS10 Series
EPCM1.5S	50	18 x 26.5 x 12	CM1.5S / CM1.5S2
EPCM2.5S	50	20 x 30 x 12.45	CM2.5S / CM2.5S2
EPCM4S	50	23 x 33.7 x 14.5	CM4S / CM4S2
EPCMS2.5	50	25 x 31 x 1.5	CMS2.5
EPCX2.5SN	50	36.8 x 15.9 x 0.5	CX2.5SN

END PLATES

End Plates are used to cover the live parts of the last Terminal Block. They should be used at the end of an assembly of identical Terminal Blocks and whenever is changed in physical size of the Terminal Block.

Part No.	Std. Pack	Dimension (H x W x T)	Suitable for
EPCXM2.5	50	29.5 x 37 x 1.5	CXM2.5 / CXMG2.5
EPCXCP2.5	50	27.3 x 35 x 3	CXCP2.5/4
EPCPTL2.5	30	49.5 x 101.9 x 1.5	CPTL2.5 Series
EPCP4LG2.5	30	118.6 x 93 x 1.5	CP4LG2.5
EPCP1.5	50	26.35 x 45.3 x 1.5	CP1.5 / CPG1.5
EPCP1.5/3	50	26.35 x 54.4 x 1.5	CP1.5/3 / CPG1.5/3
EPCP1.5/4	50	26.35 x 63.5 x 1.5	CP1.5/4 / CPG1.5/4
EPCPDL1.5	50	37.55 x 67.2 x 1.5	CPDL1.5 Series
EPCPDLK2.5	50	107 x 38.1 x 1.5	CPDLK2.5 Series
EPCPPT2.5/3	50	79.8 x 40.3 x 1.5	CPPT & CPST Series
EPCPPT2.5/3	50	96.5 x 40.3 x 1.5	CPPT & CPST Series
EPCYDL2.5/4	50	58.1 x 69.5 x 1.5	CYDL Series
EPCY2.5/10	50	41.35 x 50 x 1.5	CY2.5 to CY10 Series

PARTITION PLATES

Partition Plates are used to segregate different groups of Terminal Blocks and provide the required creepage and clearance values in an assembly. Partition Plates electrically isolate adjacent Jumpers. They also provide a separation between Terminal Blocks of different potentials.

For visual separation of different circuits, a choice of coloured End Plates and Partition Plates are also available.

Part No.	Std. Pack	Dimension (H x W x T)	Suitable for
PP2.5/4UN	50	37 x 44 x 1.6	CTS2.5UN/2.5UE/4UN/CTT2.5UK/T/J/E
PP6/10U	50	37.5 x 56 x 1.5	CTS6U/CTS10U
PP25UN	50	42.5 x 62 x 1	CTS25UN
PP35UN	50	50 x 64.5 x 1	CTS35UN
PPCMT4	50	32 x 37 x 1.6	CMT4
PPCSFL4U	50	42.5 x 62 x 1.5	CSFL4U/4U(L)/CSDL4U
CTSPPO1	50	43.5 x 49 x 2.3	CTS2.5(M)
CTSPPL1L	50	63 x 40 x 2.8	CTS2.5/6/10/4SC/6SC
CTSPPB1B	50	60 x 55 x 3	CTS2.5/6/10/4SC/6SC
CTSPPP2	50	66.5 x 66 x 3	CTS16
CTSPPP3	25	59 x 67.5 x 3	CTS35
CTSPPP1SC	50	48 x 60 x 3	CTS10SC
CMSTPP	50	23 x 27 x 1.5	CMST1/CMST2
CSTSP	20	53 x 60 x 3	CSTSB3/B4/B5/N4/N5/N4(15)/N5(15)/N6
EP4P	10	70 x 160 x 2	CTS35L/70L/95L/35LS/70LS/95LS
CTSEP4	50	5 x 120 x 2.5	CTS35L/70L/35LS/70LS
PPCBB	10	45 x 120 x 2	CBB35/50 / CBB70 / CBB95
PPCBB1	10	65 x 180 x 2	CBB120 / CBB150 / CBB185
PPCX4	50	42.4 x 59 x 2	CX2.5 / CXG2.5 / CX4 / CXG4
PPCX4/3	50	42.4 x 74.7 x 2	CX2.5/3 / CXG2.5/3 / CXK2.5 / CXK4/3 / CXK4
PPCX4/4	50	42.4 x 95 x 2	CX2.5/4 / CXG2.5/4 / CX4/4 / CXK4/4
PPCX10	20	53.5 x 76 x 2	CX6 / CX10
PPCYDL2.5/4	20	70.1 x 79.5 x 2	CYDL Series
PPCY2.5/10	50	52.35 x 60 x 2	CY2.5 to CY10 Series

SEPARATOR PLATES

Separator Plates are used for electrical separation of adjacent Jumpers without the use of additional space. They can be inserted after the Terminal Blocks have been assembled on the DIN rail.

Part No.	Std. Pack	Dimension (H x W x T)	Suitable for
SP2.5/4UN	100	17.5 x 17.4 x 1.4	CTS2.5UN/2.5UE/4UN/CTT2.5UK/T/J/E
SP6/10U	100	15.4 x 16.2 x 1.5	CTS6U/CTS10U/CTS16U
SPCDL4U	100	15.4 x 16.2 x 1.6	CDL4U/4UN/CDL4U(I.S)/4UN(I.S)
SPCMB4	100	14.5 x 12 x 1.5	CMB4
SPCDLG2.5	100	11 x 10.5 x 1	CDGL2.5
SPCP8L32	10	83.2 x 120 x 3.5	CP8L32 & CP8L32(I.S)

PROTECTIVE COVERS

For protection against dust and shock, transparent protective covers can be installed above the Terminal Block assembly. The protective cover is held in place with the help of a fixing nut on the support plate.

CSP1 Support Plate is suitable for mounting CTSPC protective cover.

CSP2 Support Plate is suitable for mounting CTSPC1 protective cover.

CSP1 & CSP2 can be mounted on all DIN rails. It is advised to use standard end clamps / stops to hold the CSP1, CSP2 in place.



Part No.	Length	Std. Pack	Suitable For
CTSPC(40mm)	40 mm	10	CSP1
CTSPC(90mm)	90 mm	10	CSP1
CTSPC(100mm)	100 mm	10	CSP1
CTSPC(130mm)	130 mm	10	CSP1
CTSPC(150mm)	150 mm	10	CSP1
CTSPC(200mm)	200 mm	10	CSP1
CTSPC(240mm)	240 mm	10	CSP1
CTSPC(300mm)	300 mm	10	CSP1
CTSPC(330mm)	330 mm	10	CSP1
CTSPC(430mm)	430 mm	10	CSP1
CTSPC(460mm)	460 mm	10	CSP1
CTSPC(760mm)	760 mm	10	CSP1
CTSPC1(100mm)	100 mm	10	CSP2

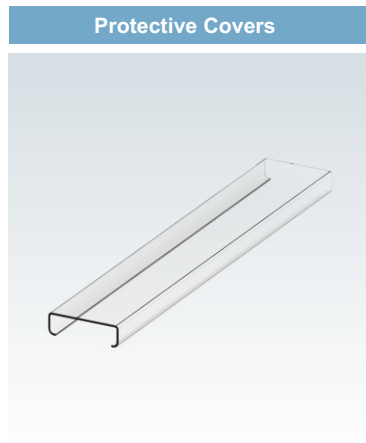

Part No.	Length	Std. Pack	Suitable For
CTSPC1(70mm)	70 mm	10	CSP1
CTSPC1(760mm)	760 mm	25	CSP2

SUPPORT PLATES

Support Plate	
Part No.	Std. Pack
CSP1	100
CSP2	25
GMH9	100

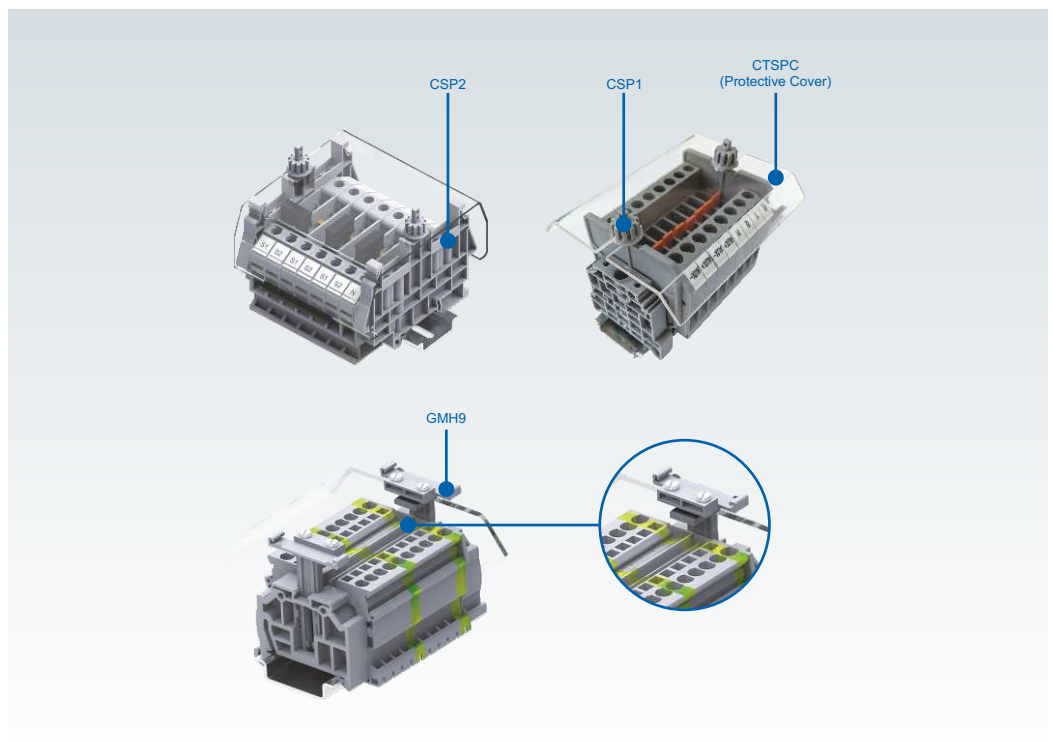

PROFESSIONAL TOOLS

In order to have secure connections, not only it is important to use good quality terminal blocks but also correct tools for securing these connections. Connectwell has a range of ergonomically designed professional tools for all your wiring needs. The tri-moulded handles of these screwdrivers allow the users to exert 50% additional torque over conventional screwdrivers. All this and more to ensure that you have The Right Connection.

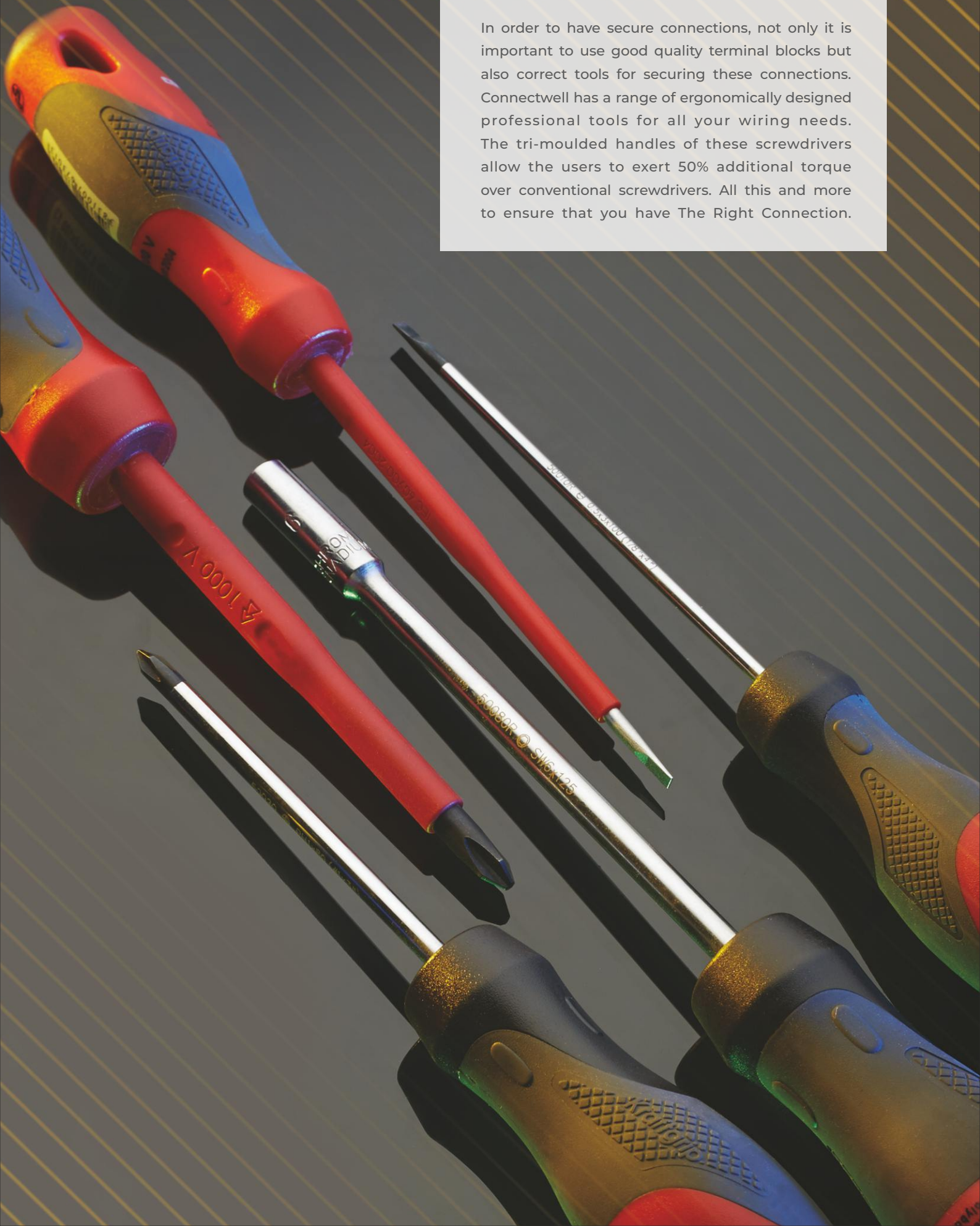

Tri-Molded PROFESSIONAL Screwdrivers

Material 1

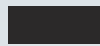

Specially formulated hard material prevents blades from turning. Handles are injection moulded around blades for maximum strength and durability.

Material 2

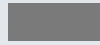

Soft TPE material, specially formulated for best torque transmission. It has an integrated diamond pattern area for better hand grip and air ventilation between the hand and the handle.

Material 3



Specially formulated reinforced material, impact resistant even at lower temperatures to prevent handle damage.

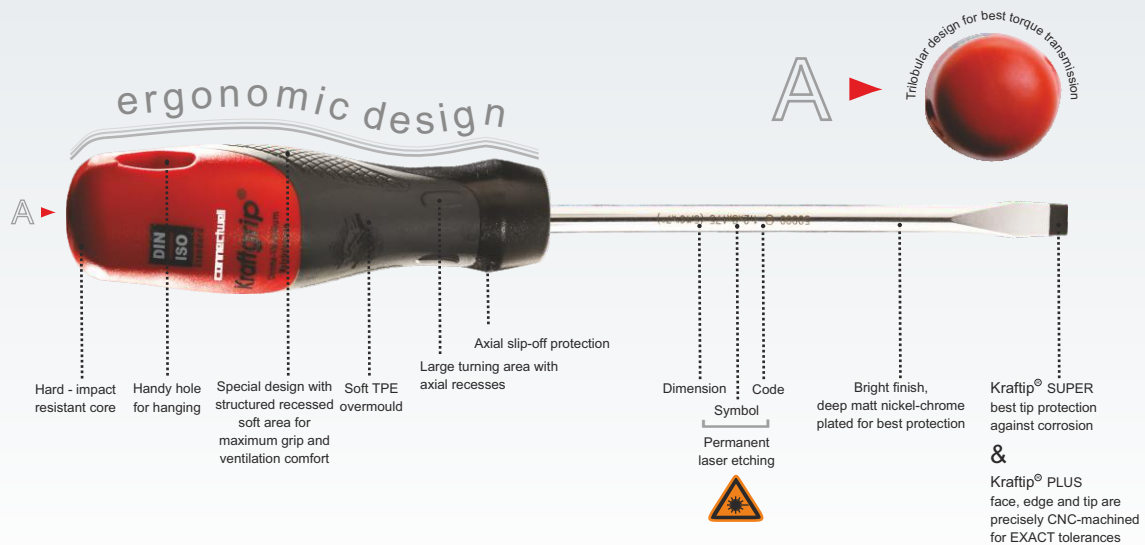

Electrician's Screwdrivers

Application: for slotted screws ISO 2380
Blade type: round blade, high-grade chrome-vanadium-molybdenum steel, chrome plated
Tip: Kraftip Plus black tip, ISO 2380-1
Handle: Three component handle, Kraftgrip 50000R

Electrician's Screwdrivers Insulated

Application: for slotted screws EN 60900:2004
Blade type: round blade, insulated high-grade chrome-vanadium-molybdenum steel, black finish
Tip: Kraftip Plus black tip, ISO 2380-1
Handle: Three component handle, Kraftgrip 50000R

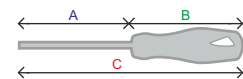
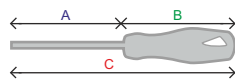

Cat. No.	EAN	⌀	↕	A	B	C	↔	Pack Pcs.
SCS0.5/3	6	0.5	3.0	100	85	185	3.0	10
SCS0.6/3.5	3	0.6	3.5	100	85	185	3.5	10
SCS0.8/4	0	0.8	4.0	125	85	210	4.0	10
SCS1/5.5	7	1.0	5.5	150	100	250	5.5	10

Cat. No.	EAN	⌀	↕	A	B	C	↔	Pack Pcs.
SCS0.5/3I	3	0.5	3.0	100	85	185	3.0	10
SCS0.6/3.5I	0	0.6	3.5	100	85	185	3.0	10
SCS0.8/4I	7	0.8	4.0	100	85	185	3.5	10
SCS1/5.5I	4	1.0	5.5	125	100	225	5.0	10



Application:

Phillips Screwdrivers

Application: for Phillips Recess screws ISO 8764

Blade type: round blade, high-grade chrome-vanadium-molybdenum steel, chrome plated

Tip: Kraftip Plus black tip, ISO 8764-1

Handle: Three component handle, Kraftgrip 50000R

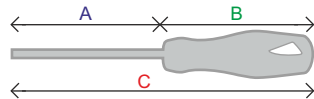

Cat. No.	EAN	+	A	B	C	→●←	Pack Pcs.	
SCPH1	5	PH	1	80	100	180	4.5	10
SCPH2	2	PH	2	100	110	210	6.0	10

AC 1000V



Phillips Screwdrivers Insulated

Application: for Phillips Recess screws EN 60900:2004

Blade type: round blade insulated, high-grade chrome-vanadium-molybdenum steel, black finish

Tip: Kraftip Plus black tip, ISO 8764-1

Handle: Three component handle, Kraftgrip 50000R

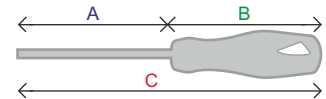

Cat. No.	EAN	+	A	B	C	→●←	Pack Pcs.	
SCPH2I	2	PH	2	100	110	210	6.0	10



Socket wrench-NUT DRIVER

Application: for hexagon headed screws, bolts and nuts DIN 3125

Blade type: round blade, with deep hexagonal socket, high-grade chrome-vanadium-molybdenum steel, chrome plated

Handle: Three component handle, Kraftgrip 50000

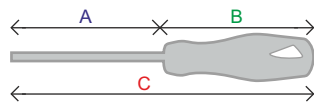

Cat. No.	EAN	⊙	Nut Size	A	B	C	→●←	Pack Pcs.
SCNT4	0	SW 4	M2	125	100	225	6	10
SCNT5	7	SW 5	M2.5	125	100	225	6	10
SCNT6	1	SW 6	M3	125	110	235	6	10

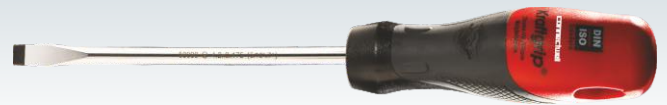

Mechanic's Screwdrivers

Application: for slotted screws ISO 2380

Blade type: round blade, high-grade chrome-vanadium-molybdenum steel, chrome plated

Tip: Kraftip Plus black tip, ISO 2380-1

Handle: Three component handle, Kraftgrip 50000R

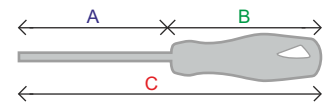

Cat. No.	EAN	⊖	⊕	A	B	C	→●←	Pack Pcs.
SCM0.4/2.5	5	0.4	2.5	75	85	160	2.5	10
SCM0.5/3	2	0.5	3.0	100	85	185	3.0	10
SCM0.8/4	6	0.8	4.0	100	85	185	4.0	10
SCM1/5.5	3	1.0	5.5	125	100	225	5.0	10

RoHS COMPLIANCE

The RoHS (Restriction of Hazardous Substances) Directive 2011/65/EU dated 8th June 2011 addresses the restriction of the use of certain hazardous substances in electrical and electronic equipment.

Producers of certain categories of electrical and electronic equipment cannot use high levels of the following six banned substances:

Lead (Pb)

Mercury (Hg)

Polybrominated biphenyls (PBB) [flame retardant]

Hexavalent chromium (Cr-VI)

Cadmium (Cd)

Polybrominated diphenyl ether (PBDE) [flame retardant]

On 4 June 2015, the EU commission has published a new Directive (EU) 2015/863 to amend Annex II to EU RoHS 2 (Directive 2011/65/EU) to add the following 4 phthalates onto the list of restricted substances

Bis(2-Ethylhexyl) phthalate (DEHP)

Dibutyl phthalate (DBP)

Benzyl butyl phthalate (BBP)

Diisobutyl phthalate (DIBP)

REACH COMPLIANCE

REACH is the regulation (EC) No 1907/2006 of the European Parliament and of the Council of 18, concerning the **R**egistration, **E**valuation, **A**uthorization and **R**estriction of **C**hemicals.

Implemented on 1st June 2007, **REACH** requires the registration of some 30000 chemical substances (over a period of 11 years) in use today, a process which will allow to fill information gaps on the hazards of substances and to identify appropriate risk management measures to ensure their safe use.

European chemical agency (ECHA) has listed various **S**ubstances of **V**ery **H**igh **C**oncern (**SVHC**). Less than 0.1% or less than 1000 ppm of **SVHC** will be allowed in REACH compliant products.



All Connectwell Terminal Blocks are
RoHS & REACH Compliant.

DIN RAIL MOUNTED SOCKETS & SWITCHES

Connectwell DIN Rail mounted socket and switches offer a unique possibility of mounting an Industrial Socket and Switch on a standard DIN rail.

Sockets are available for various country standard plugs. These need to be wired and snapped inside the Din rail mounting frame as shown in the assembly diagram below.

This assembly then easily snaps on to a standard DIN rail.

Switches CDINSW1 & CDINSW2 are available in single and double pole configuration respectively.

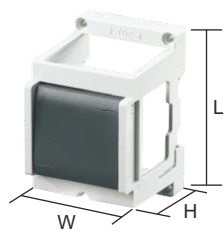

Dimension W x L x H	53 x 82 x 60 mm																			
Socket Housing Material	Polycarbonate																			
DIN Rail Frame Material	ABS																			
Wire Clamp & Contact Material	Brass																			
Electrical Data																				
Rated Connecting Capability	0.5 - 2.5 sq.mm																			
Voltage Rating	250 V																			
Current Rating	5 A																			
Suitable for Plugs	Type C, Type D (Indian Standard BS546)																			
Approvals																				
<table border="1"> <thead> <tr> <th>Type / Cat. No.</th> <th>Std. Pack</th> </tr> </thead> <tbody> <tr> <td>DIN Rail Socket</td> <td>CDINS6</td> <td>5</td> </tr> <tr> <td rowspan="2">Mounting Rail (Refer Pg. 216 for details)</td> <td>CA701-1M / CA701-1M-S</td> <td>50 m</td> </tr> <tr> <td>CA701-15-1M / CA701-15-1M-S</td> <td>50 m</td> </tr> <tr> <td rowspan="2">End Clamp (Refer Pg. 217 for details)</td> <td>CA102</td> <td>50</td> </tr> <tr> <td>CA202</td> <td>50</td> </tr> <tr> <td>Applicable Countries *</td> <td colspan="2">Afghanistan, Bangladesh, India, Nepal, Nigeria, Pakistan, Qatar, Sri Lanka</td> </tr> </tbody> </table>			Type / Cat. No.	Std. Pack	DIN Rail Socket	CDINS6	5	Mounting Rail (Refer Pg. 216 for details)	CA701-1M / CA701-1M-S	50 m	CA701-15-1M / CA701-15-1M-S	50 m	End Clamp (Refer Pg. 217 for details)	CA102	50	CA202	50	Applicable Countries *	Afghanistan, Bangladesh, India, Nepal, Nigeria, Pakistan, Qatar, Sri Lanka	
Type / Cat. No.	Std. Pack																			
DIN Rail Socket	CDINS6	5																		
Mounting Rail (Refer Pg. 216 for details)	CA701-1M / CA701-1M-S	50 m																		
	CA701-15-1M / CA701-15-1M-S	50 m																		
End Clamp (Refer Pg. 217 for details)	CA102	50																		
	CA202	50																		
Applicable Countries *	Afghanistan, Bangladesh, India, Nepal, Nigeria, Pakistan, Qatar, Sri Lanka																			

* Country data may vary. Please check the country socket configuration before ordering.

ASSEMBLY INSTRUCTIONS

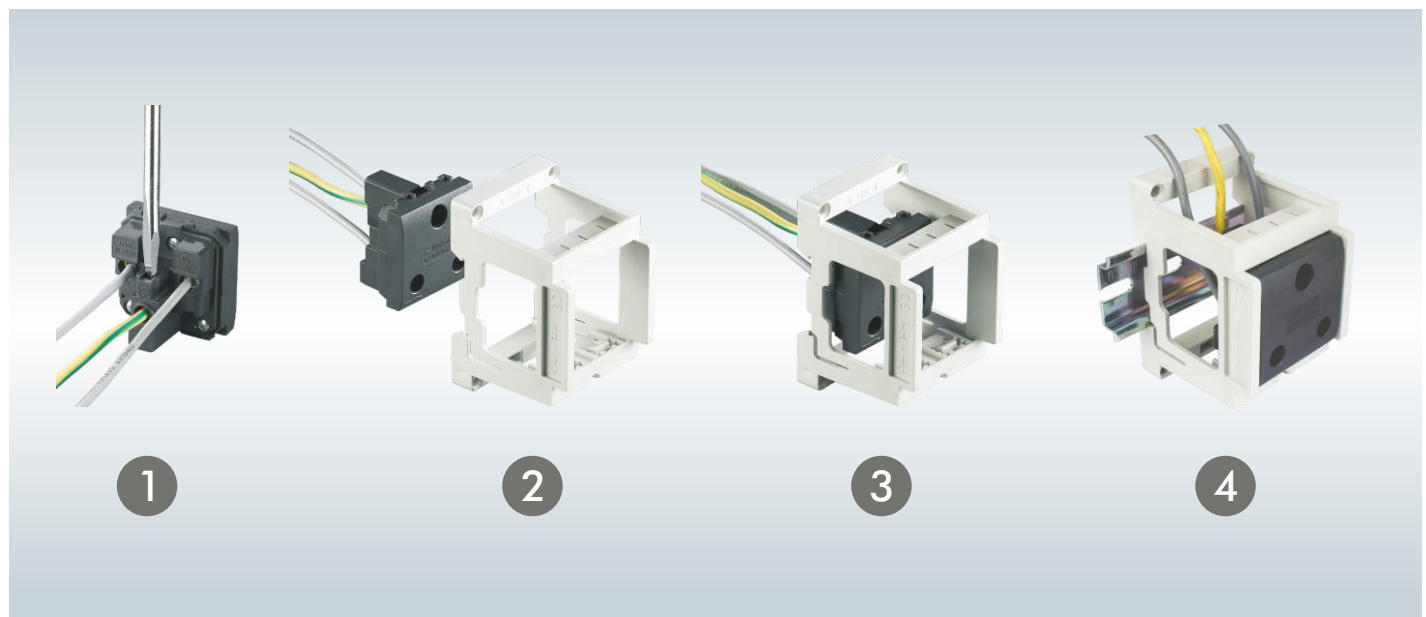

CDINS16



53 x 82 x 60 mm

Polycarbonate

ABS

Brass

0.5 - 2.5 sq.mm

250 V

15 A

Type M (South African Standard)



Type / Cat. No.	Std. Pack
CDINS16	5
CA701-1M / CA701-1M-S	50 m
CA701-15-1M / CA701-15-1M-S	50 m
CA102	50
CA202	50

Bangladesh, India, Nepal, Pakistan, Qatar, Sri Lanka, South Africa

CDINSUK



53 x 82 x 60 mm

Polycarbonate

ABS

Brass

0.5 - 2.5 sq.mm

250 V

13 A

Type G (UK Standard BS1363)



Type / Cat. No.	Std. Pack
CDINSUK	5
CA701-1M / CA701-1M-S	50 m
CA701-15-1M / CA701-15-1M-S	50 m
CA102	50
CA202	50

Bahrain, Hongkong, Iraq, Ireland, Jordan, Kenya, Kuwait, Lebanon, Macau, Malaysia, Mauritius, Myanmar, Nigeria, Oman, Qatar, Saudi Arabia, Singapore, United Arab Emirates, United Kingdom, Yemen, Zimbabwe

CDINSD



53 x 82 x 60 mm

Polycarbonate

ABS

Brass

0.5 - 2.5 sq.mm

250 V

16 A

Type F (Schuko)



Type / Cat. No.	Std. Pack
CDINSD	5
CA701-1M / CA701-1M-S	50 m
CA701-15-1M / CA701-15-1M-S	50 m
CA102	50
CA202	50

Algeria, Austria, Bosnia, Bulgaria, Finland, France, Germany, Greece, Hungary, Iceland, Indonesia, Italy, Jordan, Luxembourg, Monaco, Myanmar, Netherlands, Norway, Portugal, Romania, Serbia, Spain, Turkey

CDINSW1



Dimension W x L x H

Switch Housing Material

DIN Rail Frame Material

Wire Clamp & Contact Material

Electrical Data

Rated Connecting Capability

Voltage Rating

Current Rating

Number of Poles

Approvals

DIN Rail Socket

Mounting Rail (Refer Pg. 216 for details)



End Clamp (Refer Pg. 217 for details)



53 x 82 x 60 mm

Polycarbonate

ABS

Brass

0.5 - 2.5 sq.mm

250 V

16 A

1



Type / Cat. No.	Std. Pack
CDINSW1	5
CA701-1M / CA701-1M-S	50 m
CA701-15-1M / CA701-15-1M-S	50 m
CA102	50
CA202	50

CDINSW2



53 x 82 x 60 mm

Polycarbonate

ABS

Brass

0.5 - 2.5 sq.mm

250 V

16 A

2



Type / Cat. No.	Std. Pack
CDINSW2	5
CA701-1M / CA701-1M-S	50 m
CA701-15-1M / CA701-15-1M-S	50 m
CA102	50
CA202	50



ATEX-IECEX Approved Terminal Blocks

The ATEX - IECEX Directive besides taking into account the electrical sources of explosion, also considers potentially explosive concentrations of gas, vapor or mist along with dust in the air.

Note: When specific ATEX - IECEX / AEX / In Metro approved Terminal Blocks are required, please specifically mentioned this in your purchase orders. Such orders will be processed with due consideration.

Connectwell Terminal Blocks having ATEX - IECEX approval will be marked as follows:

ATEX-IECE_x APPROVED TERMINAL BLOCKS

Condition of Safe Use – increased safety "e"

The Terminal Blocks are suitable to mount on DIN35/ DIN32/ DIN15 as applicable. The Terminal blocks are suitable for use in ATEX / IECEx certified enclosure with minimum IP rating of IP 54.

The Terminal Block has to be built into the enclosure with the type of protection "t" (complying with IEC/EN60079-31)" standard when placed in dust atmosphere. The terminal blocks are suitable for maximum service temperature 110°C, considering the self-heating when used at rated current with specified maximum conductor size & at ambient temperature range of -60°C to +66°C at mounting position. When the Terminal Blocks are used in electrical apparatus, the highest temperature of the insulating material shall not exceed the max value of the temperature 110 °C.

When these Terminal Blocks are mounted, the minimum Creepage and Clearance distances shall be maintained for respective voltage rating, with neighboring Terminal Blocks. Proper care should be taken for stranded wire type of connection in Terminal Blocks, so that conductors do not get damaged while installation.

Installation instruction - Intrinsic Safety "i"

IEC/EN 60079-14:2013 Ed.5 Clause 12 states Modular Terminal Blocks as simple apparatus when used in intrinsically safe circuits. Testing by a notified body and marking is not required. If Terminal Blocks are identified as part of an intrinsically circuit are marked by a color, the color used shall be light blue. Testing for compliance to intrinsically safe requirements including clearance, Creepage, and solid insulation distances specified in EN IEC 60079-0:2018 and IEC 60079-0:2017 and EN 60079-11:2012 and IEC 60079-11 (2011) Ed.6 (2011) Ed.6 have been performed for circuits up to 60 V. Compliance with distance requirements of IEC/EN 60079-14:2013 Ed.5 Clause 12.2.3 for the connection of separated intrinsically safe circuit accessories is met. A minimum distance of 50 mm to separate clamping units of intrinsically safe and non-intrinsically safe circuits is required by using a partition plate or spacer or similar device.

Schedule of Limitations:

- 1) The Terminal Blocks are suitable to mount on DIN35/ DIN32/ DIN15 as applicable.
- 2) The Terminal blocks are suitable for use in ATEX / IECEx certified enclosure with minimum IP rating of IP 54.
- 3) The terminals have a maximum temperature rise of 40K for the current bars & 42 k for the thermoplastic housing & are suitable for installation in an ambient temperature of -60°C to +66°C. The terminal blocks are suitable for maximum service temperature 110°C, considering the self-heating when used at rated current with specified maximum conductor size & at ambient temperature range of -60°C to +66°C at mounting position. When the Terminal Blocks are used in electrical apparatus, the highest temperature of the insulating material shall not exceed the max value of the temperature 110 °C.
- 4) When these terminal blocks are mounted, the minimum Creepage and Clearance distances with neighboring terminal blocks and between the current bar & DIN-Rail shall be maintained as per the table given below:-

VOLTAGE (V)	CREEPAGE(mm)	CLEARANCE(mm)
630	12	10
500	10	8
400	8	6
320	6.3	6

- 5) To avoid the risk of short-circuits between adjacent conductors in terminal blocks; the insulation of each conductor shall be maintained up to the metal of the terminal.
- 6) All terminal screws and nuts used shall be tightened down wherever applicable as per the torque values specified in the table on page 2.
- 7) The housing material of the terminal blocks is not rated for UV protection. The terminal blocks are not to be installed in an enclosure with a glass or transparent plastic window or cover unless suitable protected against direct sunlight.
- 8) When used in intrinsically safe circuits, the terminals shall not be used for voltages above 60 V peak.
- 9) Where the terminals of intrinsically safe and non-intrinsically safe circuits are in the same enclosure, measures shall be taken to maintain at least 50 mm separation, using a spacer or similar device. Alternatively, a partition meeting the requirements of the relevant code of practice (e.g. IEC 60079-14) shall be used.
- 10) When used as part of an intrinsically safe circuit, terminal blocks shall meet the requirements for a T4 temperature class.
- 11) Proper care should be taken for stranded wire type of connection in terminal blocks, so that conductors do not get damaged while installation.
- 12) When the device is mounted in a hazardous area, connection and disconnection of the device from the rail while live is only permitted if the potentially explosive atmosphere is shown to be absent. This restriction does not apply if the circuit is intrinsically safe.

For Fuse & Disconnecting Terminal Block

- 13) For Fuse terminals the supply must be switched off before lifting the fuse carrier from the base terminal.
(Do not actuate the disconnecting knife or fuse carrier when energized). Do not replace or remove the fuse when energized.
- 14) Fuse terminals: The replacement fuses shall be, either FSF series manufactured by Schurter, or PSF series manufactured by Protectron or equivalent UL approved. The size of the fuse is Ø 5 X 20mm. The fuse shall be selected so that it is of non-renewable type & it is used within the manufacturers' ratings: breaking capacity, rated current and voltage rating. The rated current shall not exceed 6.3A. The equipment manufacturer / End user shall include the correct type & value of the fuse details adjacent to the fuse holders.
- 15) For fuse terminal blocks Ex ic fuse terminals shall only be mounted inside a suitably-certified flameproof enclosure.
- 16) For Screw & Spring disconnecting terminal blocks with hinge operated disconnecting knife - Disconnecting Terminals shall only be operated when the circuit is electrically isolated this restriction does not apply if the circuit is intrinsically safe circuit

ATEX-IECE_x APPROVED TERMINAL BLOCKS

Marking :

For increased safety 'e'
IECE_x SIR 20.0046U
Ex eb IIC Gb

For intrinsic safety 'i'
IECE_x SIR 20.0046U
Ex ib IIC Gb

Ambient Temperature range : -60°C to +66°C
Service Temperature range : -60°C to +110°C

Insulation Material: Polyamide 66, CTI 600 / Material Group I.

Terminal Block	Increased Safety 'e' Voltage (V)	Current (A)	Wire Size (sq.mm)	Intrinsic Safety 'i' Voltage (V)	Stripping Length (mm)	Torque (Nm)
CTS2.5UN	690 V	21	0.5-2.5	60	9	0.4
CTS2.5UE	690 V	28	0.5-4	60	9	0.5
CTS4UN	690 V	28	0.5-4	60	9	0.5
CTS6U	690 V	36	1.5-6	60	12	0.8
CTS10U	690 V	50	1.5-10	60	12	1.2
CTS16U	690 V	66	2.5-16	60	12	1.2
CTS25UN	690 V	88	6 - 25	60	14	2
CTS35UN	800 V	109	10 - 35	60	16	2.5
CTS50 / 70N	800 V	172	10 - 70	60	22	3
CTS50 / 70NA	800 V	172	10 - 70	60	22	3
CTS95 / 120N	800 V	242	25 - 120	60	24	6
CMC1-2	690 V	28	0.5-4	60	9	0.5
CMC2-2	690 V	28	0.5-4	60	9	0.5
CDL4UN	440 V	28	0.5-4	60	8	0.5
CDL4UN(I.S.)	440 V	28	0.5-4	60	8	0.5
ODL4U	550 V	28	0.5-4	60	9	0.5
CTL2.5U	440 V	21	0.5-2.5	60	8	0.4
CTL2.5U(I.S)	440 V	21	0.5-2.5	60	8	0.4
CGT4U	500 V	NA	0.5-4	60	9	0.5
CGT4N	440 V	NA	0.5-4	60	9	0.5
CGT6N	630 V	NA	0.5-6	60	12	0.8
CGT10N	630 V	NA	1.5-10	60	12	1.2
CGT10U	630 V	NA	1.5-10	60	12	1.2
CGT16N	630 V	NA	2.5-16	60	14	1.2
CGT35U	630 V	NA	10 - 35	60	18	2.5
CGT50/70N	800 V	NA	10 - 70	60	22	3
CGT50/70NA	800 V	NA	10 - 70	60	22	3
CMCG4	630 V	NA	0.2-4	60	9	0.5
CDLG4	400 V	28A (Only Top CB)	0.2-4	60	8	0.5
CDLG4(I.S.)	400 V	NA	0.2 - 4	60	8	0.5
CMT4	350 V	28	0.5-4	60	8	0.5
CGMT4	350 V	NA	0.5-4	60	9	0.5
CMB4	350 V	28	0.5-4	60	8	0.5
ODL2.5	500 V	21	0.2 - 2.5	60	8	0.4
ODL2.5(I.S)	500 V	21	0.2 - 2.5	60	8	0.4
ODL2.5A	500 V	21	0.2 - 2.5	60	8	0.4
ODL2.5A(I.S)	500 V	21	0.2 - 2.5	60	8	0.4
ODLG2.5(I.S)	500 V	NA	0.2 - 2.5	60	8	0.4
ODLG2.5A(I.S)	500 V	NA	0.2 - 2.5	60	8	0.4
CX2.5	630 V	21	0.2-2.5	60	10	NA
CX2.5/3	630 V	21	0.2-2.5	60	10	NA
CX2.5/4	630 V	21	0.2-2.5	60	10	NA
CX4	630 V	28	0.2-4	60	10	NA
CX4/3	630 V	28	0.2-4	60	10	NA
CX4/4	630 V	28	0.2-4	60	10	NA
CX6	630 V	36	0.2 -6	60	14	NA
CX6/3	630 V	36	0.2 -6	60	14	NA
CX10	630 V	51	0.2-10	60	18	NA
CX10/3	630 V	51	0.2-10	60	18	NA
CSC16T	630 V	66	1.5 - 16	60	20	NA

Terminal Block	Increased Safety 'e' Voltage (V)	Current (A)	Wire Size (sq.mm)	Intrinsic Safety 'i' Voltage (V)	Stripping Length (mm)	Torque (Nm)
CXDB35/10	630 V	I/P - 113 O/P - 36	I/P - 1.5 -35 O/P - 0.2 -10	60	I/P - 17 O/P -15	I/p: 2.5 O/p: N.A.
CXDB35/10A	630 V	I/P - 113 O/P - 36	I/P - 1.5 -35 O/P - 0.2 -10	60	I/P - 17 O/P -15	I/p: 2.5 O/p: N.A.
CXDL2.5	630 V	21	0.2-2.5	60	10	NA
CXDL2.5(I.S.)	630 V	21	0.2-2.5	60	10	NA
CSCP2.5T	440 V	21	0.2 - 2.5	60	11	NA
CSCP2.5T	440 V	21	0.2 - 2.5	60	11	NA
CXM2.5	630 V	21	0.2 - 2.5	60	10	NA
CXS2.5	630 V	21	0.2-2.5	60	9	NA
CXS4	630 V	28	0.2 - 4	60	10	NA
CM1.5S	320 V	15	0.2-1.5	60	8	NA
CM1.5S2	320 V	15	0.2-1.5	60	8	NA
CM2.5S	320 V	21	0.2-2.5	60	9	NA
CM2.5S2	320 V	21	0.2-2.5	60	9	NA
CM4S	500 V	28	0.2 - 4	60	10	NA
CM4S2	500 V	28	0.2 - 4	60	10	NA
CXG2.5	630 V	NA	0.2-2.5	60	10	NA
CXG2.5/3	630 V	NA	0.2-2.5	60	10	NA
CXG2.5/4	630 V	NA	0.2-2.5	60	10	NA
CXG4	630 V	NA	0.2-4	60	10	NA
CXG4/3	630 V	NA	0.2-4	60	10	NA
CXG4/4	630 V	NA	0.2-4	60	10	NA
CXG6	630 V	NA	0.2 - 6	60	14	NA
CXG6/3	630 V	NA	0.2 - 6	60	14	NA
CXG10	630 V	NA	0.2-10	60	18	NA
CXG10/3	630 V	NA	0.2-10	60	18	NA
CSCG16T	630 V	NA	1.5 - 16	60	20	NA
CXDLG2.5(I.S.)	630 V	NA	0.2-2.5	60	10	NA
CXMG2.5	630 V	NA	0.2 - 2.5	60	10	NA
CXSG2.5	630 V	NA	0.2-2.5	60	9	NA
CXSG4	630 V	NA	0.2 - 4	60	10	NA
CY2.5	800 V	21	0.2 - 2.5	60	8	0.4
CY4	800 V	28	0.2 - 4	60	9	0.5
CY4/3	400 V	28	0.2 - 4	60	9	0.5
CY4/4	400 V	28	0.2 - 4	60	9	0.5
CY6	630 V	36	0.2 - 6	60	10	0.8
CY10	630 V	51	0.2 - 10	60	11	1.2
CYDL2.5	630 V	21	0.2 - 2.5	60	8	0.4
CYDL4	500 V	28	0.2 - 4	60	9	0.5
CYDL4(I.S.)	500 V	28	0.2 - 4	60	9	0.5
CYG2.5	800 V	NA	0.2 - 2.5	60	8	0.4
CYG4	800 V	NA	0.2 - 4	60	9	0.5
CYG4/3	400 V	NA	0.2 - 4	60	9	0.5
CYG4/4	400 V	NA	0.2 - 4	60	9	0.5
CYG6	630 V	NA	0.2 - 6	60	10	0.8
CYG10	630 V	NA	0.2 - 10	60	11	1.2
CYDLG2.5(I.S.)	630 V	NA	0.2 - 2.5	60	8	0.4
CYDLG4(I.S.)	500 V	NA	0.2 - 4	60	9	0.5
CP1.5	630 V	13	0.2 -1.5	60	8	N.A
CP2.5	630 V	21	0.2-2.5	60	10	N.A
CP2.5/4	630 V	21	0.2-2.5	60	10	N.A
CP4	630 V	28	0.2-4	60	10	N.A
CP6/10	630 V	51	0.5 -10	60	13	N.A
CP6/10/3	630 V	51	0.5 -10	60	13	N.A
CPDL1.5	630 V	13	0.2-1.5	60	8	N.A
CPDL1.5(I.S.)	630 V	13	0.2-1.5	60	8	N.A
CPG1.5	630 V	NA	0.2-1.5	60	8	N.A
CPG2.5	630 V	NA	0.2-2.5	60	10	N.A
CPG2.5/4	630 V	NA	0.2-2.5	60	10	N.A
CPG4	630 V	NA	0.2-4	60	10	N.A
CPG6/10	630 V	NA	0.5 -10	60	13	N.A
CPG6/10/3	630 V	NA	0.5 -10	60	13	N.A
CPDLG1.5(I.S.)	630 V	NA	0.2-1.5	60	8	N.A
CXF4	630	6.3	0.2 - 4	60	10	N.A.
CXF4L	630	6.3	0.2 - 4	60	10	N.A.

ATEX-IECE_x APPROVED TERMINAL BLOCKS

Marking :

For increased safety 'e'
IECE_x SIR 20.0046U
Ex eb IIC Gb

For intrinsic safety 'i'
IECE_x SIR 20.0046U
Ex ib IIC Gb

Ambient Temperature range : -60°C to +66°C
Service Temperature range : -60° C to +110°C

Insulation Material: Polyamide 66,
CTI 600 / Material Group I.

Terminal Block	Increased Safety 'e' Voltage (V)	Current (A)	Wire Size (sq.mm)	Intrinsic Safety 'i' Voltage (V)	Stripping Length (mm)	Torque (Nm)
CF4U	500	6.3	0.2 - 4	60	8	0.5
CF4UL	500	6.3	0.2 - 4	60	8	0.5
CKT4U	630	24	0.2 - 4	60	8	0.5
CKT4U/4	630	24	0.2 - 4	60	8	0.5
CXK2.5	630	17	0.2 - 2.5	60	10	N.A.
CXK2.5/4	630	17	0.2 - 2.5	60	10	N.A.

Marking :

For increased safety 'e'
2813  CSANe 21ATEX3017U
II 2G Ex eb IIC Gb

For increased safety 'i'
2813  CSANe 21ATEX3017U
II 2G Ex eb IIC Gb

Ambient Temperature range : -40°C to +40°C
Service Temperature range : -40° C to +85°C

Insulation Material: Polyamide 66,
CTI 600 / Material Group I.

Terminal Block	Increased Safety 'e' Voltage (V)	Current (A)	Wire Size (sq.mm)	Intrinsic Safety 'i' Voltage (V)	Stripping Length (mm)	Torque (Nm)
CTS2.5UN	690 V	21	0.5-2.5	60	9	0.4
CTS2.5UE	690 V	28	0.5-4	60	9	0.5
CTS4UN	690 V	28	0.5-4	60	9	0.5
CTS6U	690 V	36	1.5-6	60	12	0.8
CTS10U	690 V	50	1.5-10	60	12	1.2
CTS16U	690 V	66	2.5-16	60	12	1.2
CTS25UN	690 V	88	6 - 25	60	14	2
CTS35UN	800 V	109	10 - 35	60	16	2.5
CTS50 / 70N	800 V	172	10 - 70	60	22	3
CTS50 / 70NA	800 V	172	10 - 70	60	22	3
CTS95 / 120N	800 V	242	25 - 120	60	24	6
CMC1-2	690 V	28	0.5-4	60	9	0.5
CMC2-2	690 V	28	0.5-4	60	9	0.5
CDL4UN	440 V	28	0.5-4	60	8	0.5
CDL4UN(I.S.)	440 V	28	0.5-4	60	8	0.5
ODL4U	550 V	28	0.5-4	60	9	0.5
CTL2.5U	440 V	21	0.5-2.5	60	8	0.4
CTL2.5U(I.S)	440 V	21	0.5-2.5	60	8	0.4
CGT4U	500 V	NA	0.5-4	60	9	0.5
CGT4N	440 V	NA	0.5-4	60	9	0.5
CGT6N	630 V	NA	0.5-6	60	12	0.8
CGT10N	630 V	NA	1.5-10	60	12	1.2
CGT10U	630 V	NA	1.5-10	60	12	1.2
CGT16N	630 V	NA	2.5-16	60	14	1.2
CGT35U	630 V	NA	10 - 35	60	18	2.5
CGT50/70N	800 V	NA	10 - 70	60	22	3
CGT50/70NA	800 V	NA	10 - 70	60	22	3
CMCG4	630 V	NA	0.2-4	60	9	0.5
CDLG4	400 V	28A (Only Top CB)	0.2-4	60	8	0.5
CDLG4(I.S.)	400 V	NA	0.2 - 4	60	8	0.5
CMT4	350 V	28	0.5-4	60	8	0.5
CGMT4	350 V	NA	0.5-4	60	9	0.5
CMB4	350 V	28	0.5-4	60	8	0.5

Marking :

For increased safety 'e'

2813  CSANe 21ATEX3017U

II 2G Ex eb IIC Gb

For increased safety 'i'

2813  CSANe 21ATEX3017U

II 2G Ex eb IIC Gb

Ambient Temperature range : -40°C to +40°C

Service Temperature range : -40° C to +85°C

Insulation Material: Polyamide 66,
CTI 600 / Material Group I.

Terminal Block	Increased Safety 'e' Voltage (V)	Current (A)	Wire Size (sq.mm)	Intrinsic Safety 'i' Voltage (V)	Stripping Length (mm)	Torque (Nm)
ODL2.5	500 V	21	0.2 - 2.5	60	8	0.4
ODL2.5(I.S)	500 V	21	0.2 - 2.5	60	8	0.4
ODL2.5A	500 V	21	0.2 - 2.5	60	8	0.4
ODL2.5A(I.S)	500 V	21	0.2 - 2.5	60	8	0.4
ODLG2.5(I.S)	500 V	NA	0.2 - 2.5	60	8	0.4
ODLG2.5A(I.S)	500 V	NA	0.2 - 2.5	60	8	0.4
CX2.5	630 V	21	0.2-2.5	60	10	NA
CX2.5/3	630 V	21	0.2-2.5	60	10	NA
CX2.5/4	630 V	21	0.2-2.5	60	10	NA
CX4	630 V	28	0.2-4	60	10	NA
CX4/3	630 V	28	0.2-4	60	10	NA
CX4/4	630 V	28	0.2-4	60	10	NA
CX6	630 V	36	0.2 - 6	60	14	NA
CX6/3	630 V	36	0.2 - 6	60	14	NA
CX10	630 V	51	0.2-10	60	18	NA
CX10/3	630 V	51	0.2-10	60	18	NA
CSC16T	630 V	66	1.5 - 16	60	20	NA
CXDB35/10	630 V	I/P - 113 O/P - 36	I/P - 1.5 -35 O/P - 0.2 -10	60	I/P - 17 O/P -15	I/p: 2.5 O/p: N.A.
CXDB35/10A	630 V	I/P - 113 O/P - 36	I/P - 1.5 -35 O/P - 0.2 -10	60	I/P - 17 O/P -15	I/p: 2.5 O/p: N.A.
CXDL2.5	630 V	21	0.2-2.5	60	10	NA
CXDL2.5(I.S.)	630 V	21	0.2-2.5	60	10	NA
CSCP2.5T	440 V	21	0.2 - 2.5	60	11	NA
CSCP2.5T	440 V	21	0.2 - 2.5	60	11	NA
CXM2.5	630 V	21	0.2 - 2.5	60	10	NA
CXS2.5	630 V	21	0.2-2.5	60	9	NA
CXS4	630 V	28	0.2 - 4	60	10	NA
CM1.5S	320 V	15	0.2-1.5	60	8	NA
CM1.5S2	320 V	15	0.2-1.5	60	8	NA
CM2.5S	320 V	21	0.2-2.5	60	9	NA
CM2.5S2	320 V	21	0.2-2.5	60	9	NA
CM4S	500 V	28	0.2 - 4	60	10	NA
CM4S2	500 V	28	0.2 - 4	60	10	NA
CXG2.5	630 V	NA	0.2-2.5	60	10	NA
CXG2.5/3	630 V	NA	0.2-2.5	60	10	NA
CXG2.5/4	630 V	NA	0.2-2.5	60	10	NA
CXG4	630 V	NA	0.2-4	60	10	NA
CXG4/3	630 V	NA	0.2-4	60	10	NA
CXG4/4	630 V	NA	0.2-4	60	10	NA
CXG6	630 V	NA	0.2 - 6	60	14	NA
CXG6/3	630 V	NA	0.2 - 6	60	14	NA
CXG10	630 V	NA	0.2-10	60	18	NA
CXG10/3	630 V	NA	0.2-10	60	18	NA
CSCG16T	630 V	NA	1.5 - 16	60	20	NA
CXDLG2.5(I.S.)	630 V	NA	0.2-2.5	60	10	NA
CXMG2.5	630 V	NA	0.2 - 2.5	60	10	NA
CXSG2.5	630 V	NA	0.2-2.5	60	9	NA
CXSG4	630 V	NA	0.2 - 4	60	10	NA
CY2.5	800 V	21	0.2 - 2.5	60	8	0.4
CY4	800 V	28	0.2 - 4	60	9	0.5
CY4/3	400 V	28	0.2 - 4	60	9	0.5
CY4/4	400 V	28	0.2 - 4	60	9	0.5

ATEX-IECE_x APPROVED TERMINAL BLOCKS**Marking :**

For increased safety 'e'
2813 Ex CSANe 21ATEX3017U
II 2G Ex eb IIC Gb

For increased safety 'i'
2813 Ex CSANe 21ATEX3017U
II 2G Ex eb IIC Gb

Ambient Temperature range : -40°C to +40°C
Service Temperature range : -40°C to +85°C

Insulation Material: Polyamide 66,
CTI 600 / Material Group I.

Terminal Block	Increased Safety 'e' Voltage (V)	Current (A)	Wire Size (sq.mm)	Intrinsic Safety 'i' Voltage (V)	Stripping Length (mm)	Torque (Nm)
CY6	630 V	36	0.2 - 6	60	10	0.8
CY10	630 V	51	0.2 - 10	60	11	1.2
CYDL2.5	630 V	21	0.2 - 2.5	60	8	0.4
CYDL2.5(I.S)	630 V	21	0.2 - 2.5	60	8	0.4
CYDL4	500 V	28	0.2 - 4	60	9	0.5
CYDL4(I.S)	500 V	28	0.2 - 4	60	9	0.5
CYG2.5	800 V	NA	0.2 - 2.5	60	8	0.4
CYG4	800 V	NA	0.2 - 4	60	9	0.5
CYG4/3	400 V	NA	0.2 - 4	60	9	0.5
CYG4/4	400 V	NA	0.2 - 4	60	9	0.5
CYG6	630 V	NA	0.2 - 6	60	10	0.8
CYG10	630 V	NA	0.2 - 10	60	11	1.2
CYDLG2.5(I.S)	630 V	NA	0.2 - 2.5	60	8	0.4
CYDLG4(I.S)	500 V	NA	0.2 - 4	60	9	0.5
CP1.5	630 V	13	0.2 - 1.5	60	8	N.A
CP2.5	630 V	21	0.2-2.5	60	10	N.A
CP2.5/4	630 V	21	0.2-2.5	60	10	N.A
CP4	630 V	28	0.2-4	60	10	N.A
CP6/10	630 V	51	0.5 - 10	60	13	N.A
CP6/10/3	630 V	51	0.5 - 10	60	13	N.A
CPDL1.5	630 V	13	0.2-1.5	60	8	N.A
CPDL1.5(I.S)	630 V	13	0.2-1.5	60	8	N.A
CPG1.5	630 V	NA	0.2-1.5	60	8	N.A
CPG2.5	630 V	NA	0.2-2.5	60	10	N.A
CPG2.5/4	630 V	NA	0.2-2.5	60	10	N.A
CPG4	630 V	NA	0.2-4	60	10	N.A
CPG6/10	630 V	NA	0.5 - 10	60	13	N.A
CPG6/10/3	630 V	NA	0.5 - 10	60	13	N.A
CPDLG1.5(I.S)	630 V	NA	0.2-1.5	60	8	N.A

Marking :

For increased safety 'e'
 Ex CSANe 21ATEX3070U
II 3G Ex ec IIC Gc

For increased safety 'i'
 Ex CSANe 21ATEX3070U
II 3G Ex ec IIC Gc

Ambient Temperature range : -60°C to +40°C
Service Temperature range : -60°C to +110°C

Insulation Material: Polyamide 66, CTI 600 / Material Group I.

Terminal Block	Increased Safety 'e' Voltage (V)	Current (A)	Wire Size (sq.mm)	Intrinsic Safety 'i' Voltage (V)	Stripping Length (mm)	Torque (Nm)
CXF4	630	6.3	0.2 - 4	60	10	N.A.
CXF4L	630	6.3	0.2 - 4	60	10	N.A.
CF4U	500	6.3	0.2 - 4	60	8	0.5
CF4UL	500	6.3	0.2 - 4	60	8	0.5
CKT4U	630	24	0.2 - 4	60	8	0.5
CKT4U/4	630	24	0.2 - 4	60	8	0.5
CXK2.5	630	17	0.2 - 2.5	60	10	N.A.
CXK2.5/4	630	17	0.2 - 2.5	60	10	N.A.

Condition of Safe Use – increased safety "e"

The Terminal Blocks are suitable to mount on DIN35/ DIN32/ DIN15 as applicable.
The Terminal blocks are suitable for use in ATEX/ IECEx certified enclosure with minimum IP rating of IP 54.

The terminal block has to be built into the enclosure with the type of protection "4" (complying with IEC/EN60079-31)" standard when placed in dust atmosphere.

The terminal blocks are suitable for maximum service temperature 85°C, considering the self-heating when used at rated current with specified maximum conductor size & at ambient temperature range of -40°C to +40°C at mounting position.

When the Terminal Blocks are used in electrical apparatus, the highest temperature of the insulating material shall not exceed the max value of the temperature 85 °C.

When these terminal blocks are mounted, the minimum Creepage and clearance distances shall be maintained for respective voltage rating, with neighboring terminal blocks.

Proper care should be taken for stranded wire type of connection in terminal blocks, so that conductors do not get damaged while installation.

Installation instruction - Intrinsic Safety "i"

IEC/EN 60079-14 Clause 12 states Modular Terminal Blocks as simple apparatus when used in intrinsically safe circuits. Testing by a notified body and marking is not required. If Terminal Blocks are identified as part of an intrinsically circuit are marked by a colour, the colour used shall be light blue. Testing for compliance to intrinsically safe requirements including clearance, creepage, and solid insulation distances specified in IEC/EN 60079-0 and IEC/EN 60079-11 have been performed for circuits up to 60 V. Compliance with distance requirements of IEC/EN 60079-14 Clause 12.2.3 for the connection of separated intrinsically safe circuit accessories is met. A minimum distance of 50 mm to separate clamping units of intrinsically safe and non-intrinsically safe circuits is required by using a partition plate or spacer or similar device.

Schedule of Limitations:

- 1) When these terminal blocks are mounted, the minimum Creepage and clearance distances with neighbouring terminal blocks and between the current bar & DIN-Rail shall be maintained as per the table given below:-

VOLTAGE (V)	CREEPAGE(mm)	CLEARANCE(mm)
1250	22	18
1000	20	14
800	16	12
630	12	10
500	10	8
400	8	6
320	6.3	6
250	5	5

- 2) To avoid the risk of short-circuits between adjacent conductors in terminal blocks; the insulation of each conductor shall be maintained up to the metal of the terminal.
- 3) All terminal screws and nuts used shall be tightened down wherever applicable as per the torque values specified in the table on page 2.
- 4) When this product is intended to be used in a potentially explosive dust atmosphere, it shall be installed in an enclosure that is suitably certified for use in that environment.
- 5) The housing material of the terminal blocks is not rated for UV protection. The terminal blocks are not to be installed in an enclosure with a glass or transparent plastic window or cover unless suitably protected against direct sunlight.
- 6) When used in intrinsically safe circuits, the terminals shall not be used for voltages above 60 V peak.
- 7) Where the terminals of intrinsically safe and non-intrinsically safe circuits are in the same enclosure, measures shall be taken to maintain at least 50 mm separation, using a spacer or similar device. Alternatively, a partition meeting the requirements of the relevant code of practice (e.g. IEC 60079-14) shall be used.
- 8) When used as part of an intrinsically safe circuit, terminal blocks shall meet the requirements for a T4 temperature class at 85°C ambient.
- 9) When the device is mounted in a hazardous area, connection and disconnection of the device from the rail while live is only permitted if the potentially explosive atmosphere is shown to be absent. This restriction does not apply if the circuit is intrinsically safe.
- 10) When used as part of an intrinsically safe circuit, terminal blocks shall be marked with a light blue colour or otherwise indicated that the circuits are intrinsically safe.

For Fuse & Disconnecting Terminal Block

- 11) For Fuse terminals the supply must be switched off before lifting the fuse carrier from the base terminal.
(Do not actuate the disconnecting knife or fuse carrier when energized). Do not replace or remove the fuse when energized.
- 12) Fuse terminals: The replacement fuses shall be, either FSF series manufactured by Schurter, or PSF series manufactured by Protectron. The size of the fuse is Ø 5 X 20mm. The fuse shall be selected so that it is used within the manufacturers' ratings: breaking capacity, rated current and voltage rating. The rated current shall not exceed 6.3A.
- 13) Fuse terminals: The fuse shall not be removed or replaced when energized.
- 14) Ex ic fuse terminals shall only be mounted inside a suitably-certified flameproof enclosure.
- 15) Disconnect terminals shall only be operated when the circuit is electrically isolated. This restriction does not apply if the circuit is intrinsically safe.
- 16) Fuses shall be marked either as increased safety or intrinsically safe, but not both.
Terminals that are marked as intrinsically safe shall be light blue.

ATEX-IECE_x APPROVED TERMINAL BLOCKS

Marking :

For increased safety 'e'

Sira 16ATEX3028U
2813 Ex II 2G Ex eb IIC Gb

For increased safety 'i'

Sira 16ATEX3028U
2813 Ex II 2G Ex eb IIC Gb

Ambient Temperature range : -40°C to +40°C

Service Temperature range : -40°C to +85°C

IECE_x SIR 16.0016U
Ex eb IIC Gb

IECE_x SIR 16.0016U
Ex eb IIC Gb

Insulation Material: Polyamide 66, CTI 600 / Material Group I.

Terminal Block	Increased Safety	Current	Wire Size	Intrinsic Safety	Stripping Length	Torque
CMS2.5	400	21	0.2 - 2.5	60	9	N.A.
CXDLG2.5	630	21 A TOP CB	0.2 - 2.5	60	10	N.A.
CSB3/N3UL	500	36	0.5 - 6	60	9	0.5
CSB3/N3U	500	36	0.5 - 6	60	9	0.5
CBS3U	500	36	0.5 - 6	60	9	0.5
CSB4/N4U	500	51	1.5 - 10	60	9	1.2
CBS4U	500	51	1.5 - 10	60	9	1.2
CSB5/N5U	630	68	1.5 - 16	60	9	2
CBS5U	630	68	1.5 - 16	60	9	2
STH3	630	36	1.5 - 6	60	8	0.5
STH4	500	36	1.5 - 6	60	10	1.2
STH6	630	110	1.5 - 35	60	12	2.5

Marking :

For increased safety 'e'

Sira 16ATEX3029U
 Ex II 3G Ex ec IIC Gc

For intrinsic safety 'i'

Sira 16ATEX3029U
 Ex II 3G Ex ic IIC Gc

Ambient Temperature range : -40°C to +40°C

Service Temperature range : -40°C to +85°C

IECE_x SIR 16.0015U
Ex ec IIC Gc

IECE_x SIR 16.0015U
Ex ic IIC Gc

Insulation Material: Polyamide 66, CTI 600 / Material Group I.

Terminal Block	Increased Safety 'e' Voltage (V)	Current (A)	Wire Size (sq.mm)	Intrinsic Safety 'i' Voltage (V)	Stripping Length (mm)	Torque (Nm)
CXCC4-CPFL	630	6.3	0.2 - 4	60	10	N.A.
CXCC4-CPF	630	6.3	0.2 - 4	60	10	N.A.
DDFL4U	500	6.3	0.2 - 4	60	8	0.5
DDFL4UE	500	6.3	0.2 - 4	60	8	0.5

ATEX-IECE_x APPROVED TERMINAL BLOCKS

Marking :

For increased safety 'e'

Sira 16ATEX3170U
2813 Ex II 2G Ex eb IIC Gb

IECE_x SIR 16.0056U
Ex eb IIC Gb

For increased safety 'i'

Sira 16ATEX3170U
2813 Ex II 2G Ex eb IIC Gb

IECE_x SIR 16.0056U
Ex eb IIC Gb

Ambient Temperature range : -40°C to +40°C

Service Temperature range : -40° C to +85°C

Insulation Material: Polyamide 66, CTI 600 / Material Group I.

Terminal Block	Increased Safety	Current	Wire Size	Intrinsic Safety	Stripping Length	Torque
CTS25U	690	88	6 - 25	60	14	2
CDL4U	350	28	0.5-4	60	8	0.5
CTL2.5UH	440	21	0.5-2.5	60	8	0.4
PTB35/50SH / PTB35/50	1100	126	16 - 50	60	18	3
AS2.5	630	21	0.34-2.5	60	11	NA
AS2.5/3	630	21	0.34-2.5	60	11	NA
AS2.5/4	630	21	0.34-2.5	60	11	NA
AS4	630	28	0.34-4	60	12	NA
AS4/3	630	28	0.34-4	60	12	NA
AS4/4	630	28	0.34-4	60	12	NA
AS6	630	36	0.34-6	60	13	NA
AS6/3	630	36	0.34-6	60	13	NA
ADL2.5	630	18	0.34-2.5	60	10	NA
AGT2.5	630	NA	0.34-2.5	60	11	NA
AGT2.5/3	630	NA	0.34-2.5	60	11	NA
AGT2.5/4	630	NA	0.34-2.5	60	11	NA
AGT4	630	NA	0.34-4	60	12	NA
AGT4/3	630	NA	0.34-4	60	12	NA
AGT4/4	630	NA	0.34-4	60	12	NA
AGT6	630	NA	0.34-6	60	13	NA
AGT6/3	630	NA	0.34-6	60	13	NA

WIRE TERMINATION

Systematic wiring in a panel board requires a layout of properly selected Terminal Blocks. In the normal course, it would be appropriate to assign one wire per clamping unit of a Terminal Block thus, simplifying the task of identification of the circuit.

The Screw Clamp Terminal Blocks can accommodate wires one size higher than the rated cross section. It must be noted that they can also take two wires one size smaller than the rated cross section.

If, however, two wires are connected to one clamping unit of a screw clamp Terminal Block, care must be taken to ensure that the total current assigned to the two wires does not exceed the continuous rating of the Terminal Block.

For 'Screwless' Spring Clamp Terminal Blocks, special care must be taken that only one wire must be connected per clamping unit.

The relevant standard, IEC 60947-7-1, section 4.3.5 states that for Terminal Blocks with a rated cross section from 0.2 sq. mm to 35 sq. mm. (both inclusive), the manufacturer shall specify the range and number of the rated cross section. The conductor can be rigid (solid or multi strands) or flexible (fine strands), these values can be found in product related technical data.

Connectwell feed through Terminal Blocks are designed to allow copper wires to be connected without any special preparations such as soldering the individual strands of wire or using cable lugs / ferrules. However, wires requiring special preparation can also be used in Connectwell Terminal Blocks, as per IEC 60947-7-1.

For connecting aluminium wires, special care must be taken while stripping the insulation from the wires. It is strictly recommended to use ferrules and lugs while connecting flexible aluminium wires. Once the wire has been stripped of its insulation to the recommended length, it should be coated with acid and alkaline free Vaseline and screwed into the terminal immediately. This procedure must be followed each time that an aluminium wire is to be disconnected and reconnected.

In applications where connections have to be changed frequently, it is recommended to use lugs/ferrules/cable sockets to avoid fracturing of individual wires.

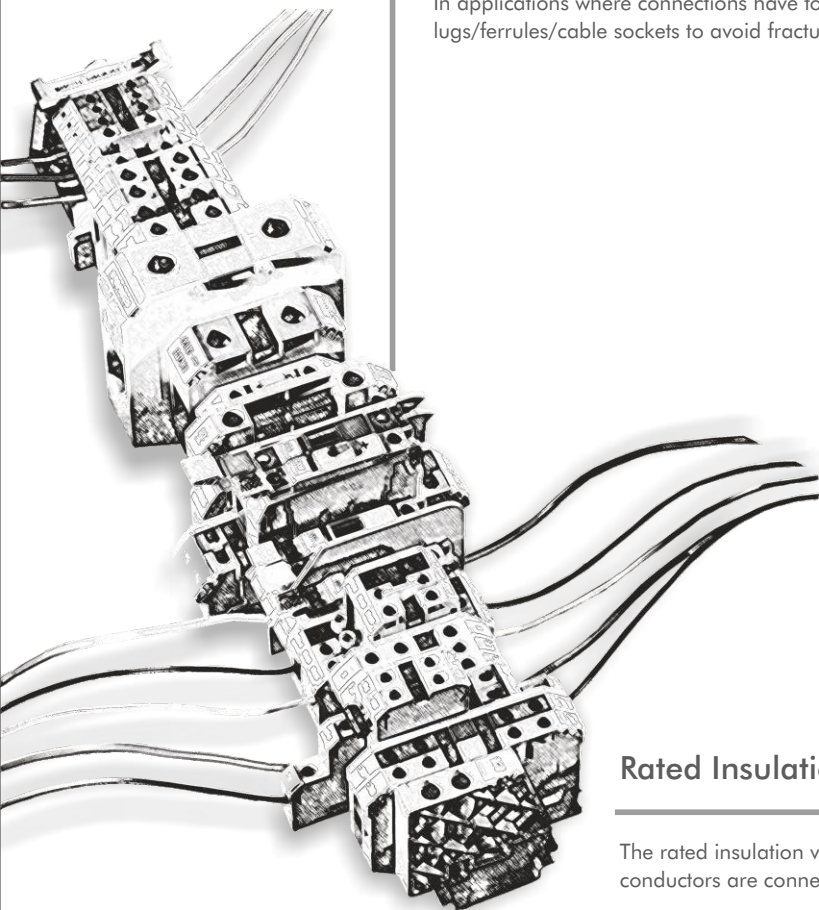

Rated Insulation Voltage with two wires/conductors

The rated insulation voltage of the Terminal Blocks does not change if the wires / conductors are connected correctly.

WIRE CONNECTION METHOD

Screw Clamp Connection

'The Screw Clamp Connection' is the most popular method of wire termination. It offers distinct advantages over the other wire termination methods:

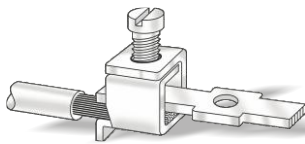

- Suitable for all cross-sections and types of wires
- Wires can be connected without any special preparation
- Provides vibration resistant connection
- Simple connection and disconnection of wires with the aid of an ordinary screw driver (Fig.1)
- The cold forged rolled threaded screws provide high tightening torque.

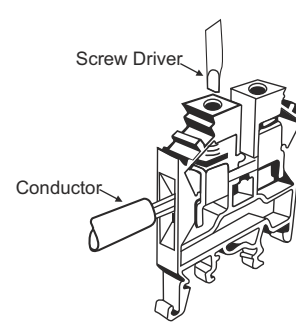

Fig. 1
Screw Clamp Operation

The steel clamping screw produces high contact force while the steel clamping yoke transmits this force by pressing the conductor against the current bar. The conducting medium within a Terminal Block is its current bar, which is made from electrolytic copper or 63 / 37 brass and tin plated. The tin plating on the current bar ensures excellent continuous contact and provides good protection against corrosion. Even the best electrical conductor materials are worthless without the required contact force to press the connected wire to the contact surface on the current bar. It is because of this that the clamping yokes and screws are made of steel. The steel parts are zinc plated and additionally chromate passivated in order to achieve the highest degree of corrosion resistance.

When the clamping screw is tightened, the clamping yoke gets pulled upwards, pressing the wire against the current bar. The clamping yoke and current bar are serrated. The serrations of the current bar cut through the oxide skin of the wire on tightening, thereby providing many contact lines. The serrations of the clamping yoke improve the gripping of the wire. When the wire is tightened, the clamping pressure pulls the top threaded surfaces of the yoke exerting extra high locking action on the clamping screw. (Fig. 2)

Changes caused by temperature variations, if any, are effectively equalised by the elasticity of steel, providing excellent vibration resistance.

Large pressure areas on the current bar and the clamping yoke prevent notching, which otherwise could lead to possible wire fracture. The clamping yokes come in different sizes and shapes to accommodate wires of different cross sections. A flat clamping area ensures safe gripping of wires of smaller cross sections. The flange / tail of the clamping yokes prevents false entry of the wires underneath the yokes.

The following characteristics make the Screw Clamp Connection user friendly, versatile and sturdy:

- Strong contact force which makes it absolutely gas tight
- Very low contact resistance
- Excellent vibration proof protection preventing loosening of screws
- Reliable electrical and mechanical connection
- Ease of handling

Cable Lug Connection

This method of wire termination is preferred for connections that are subject to very severe vibrations. The wire is crimped to a ring/fork type and is screwed on to the flat current bar in the Terminal Block.

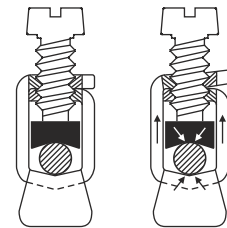
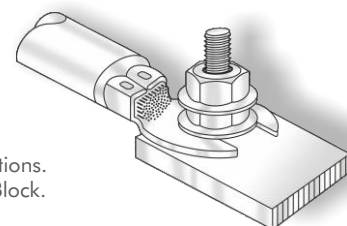
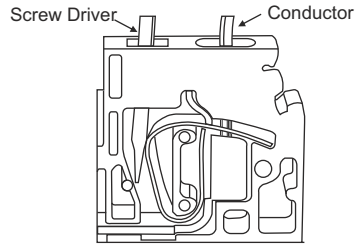
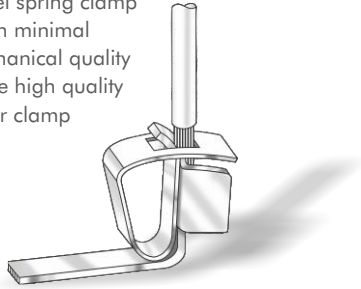

Fig. 2
Wire / Conductor Retention

Spring Clamp Technology

The more recently introduced Screwless Spring Clamp connection is as versatile as the screw clamp connection. In this type of a connection, the wire is held against the electrolytic copper current bar directly by a pre stressed spring clamp. The spring is operated by using a screw driver to provide an access to the wire through the opening in the spring clamp. The inserted wire gets clamped on to the current bar on the removal of the screw driver. The high quality stainless steel spring clamp ensures a good connection of the wire with minimal contact resistance. The electrical and mechanical quality of the wire connection is maintained by the high quality rust proof spring clamp. Only one wire per clamp must be terminated.



Screwless Spring Clamp Actuation

The following are the characteristics of Spring Clamp Connection:

- Easy to operate, versatile and vibration proof
- Minimal contact resistance because of a gas tight connection is made possible by the high quality stainless steel spring clamp
- Fail proof / safe, maintenance free connection
- The surface treated (tin plated) electrolytic copper current bar ensures oxidation free contact

Push-In Technology

Push-In Terminal Blocks have a specialized connection system that enables tool-less wire connection. Reliable, vibration resistant, gas-tight connections are made with an inbuilt high-quality stainless steel Push-In spring clamps. Lugged cable & solid wires can be directly pressed into the clamp to make connections.

The Push button on the top is pressed for using a flexible cable without lug/ferrule for connection. These Terminal Blocks can be cross connected by using pluggable jumpers available in various pole configurations.

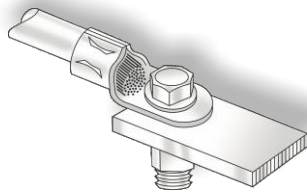
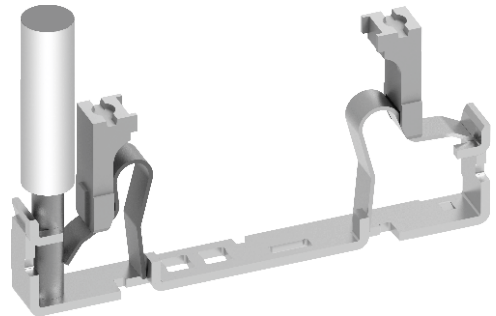

Cable Lug / Bus Bar Connection

This type of connection is preferred for wires of larger cross sections. The conductor is fit with a lug and bolted on to the flat current bar. This method is also ideal for connections subject to very severe vibrations.

Tab Connection

Tab connections are preferred in applications where the connected wire needs to be frequently connected and disconnected. A tab sleeve with a crimped wire is pushed on to the Terminal Block.

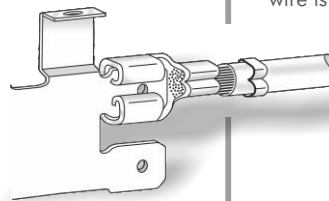

Solder Connection

Solder connections are suitable for wires having a cross section up to 2.5 sq. mm. In this type of connection, the wire is soldered to a solder lug. If done professionally, soldering can provide a good electrical connection.

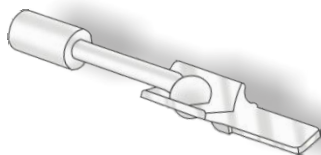

Wire Wrap Connection

This type of connection is suitable for connecting a thin solid wire. The wire is wrapped to a square pin provided in the Terminal Block. A special tool is required for wrapping the wire to the square pin.

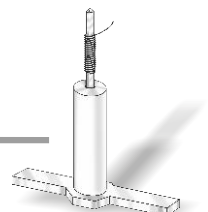

WIRE TIGHTENING

The design of the Connectwell Screw Clamps / Cable Lug system ensures vibration proof positive connection wires at the recommended torque values. However, Connectwell Terminal Blocks can withstand torque levels in excess of the recommended torque values. The Terminal Block clamping parts when tightened within the torque range ensure optimum performance as given below:

- The voltage drop (contact resistance) is well below the specified limits
- The wire gets clamped perfectly to form a gas tight connection
- The clamping yoke does not get damaged mechanically. The tightening torque according to IEC 60947-7-1 table 4, is the safe limit of the torque which guarantees the successful clamping of the connected wire.

Connectwell Terminal Blocks tightening torque data is given in the respective product pages.

All Connectwell Terminal Blocks are designed to function with rated wire sizes as per their respective AWG (American Wire Gauge) or Metric size/system. The Terminal Blocks are tested for Gauge Insertion as per VDE 0660.

Tightening Torque for Screw Clamp Terminal Blocks

Terminal Blocks	Thread Size of Fastener	Recommended Torque Value
CTS2.5UN/CPT(M)/CPT5	M 2.5	0.4 Nm
CTS2.5(M)/CMST1/CMST2	M 2.6	0.4 Nm
CTS2.5/CMT4/CMB4/CDL4U/ODL4U/ CGT4U/CTS4UN/CTS4SC/CSTSB3/CSFL4U/ CSDL4U/CKT4U/CPT7.5/DDFL4U/ DDFL4U(E)/DDFL4U(E)LR/CMC1-2/CMC2-2	M 3	0.5 Nm
CTS6/CTS6SC/CTS6U/CSFL6U/CENC4	M 3.5	0.8 Nm
CTS10/10U/CTS16/16U/CSTSN4/B4/CDTTS/ CTS10SC/CGT10U/DDPT/CDTTU/CSTSN4U/STH4	M 4	1.2 Nm
CTS25U/CSTSB5/N5/N5(15)/RN5/N5U/CENC16	M 5	2.0 Nm
CTS35/CTS35U/CENC35/CGT35U/CSTSN6U	M 6.0	2.0 Nm
CTS35L/35LS/CSTSRN6/CSTSN6	M 6.0	2.8 Nm
CTS70L/70LS	M8.0	6.0 Nm
CTS95L/95LS	M10.0	10.0 Nm

Conductor cross-sections and Gauges

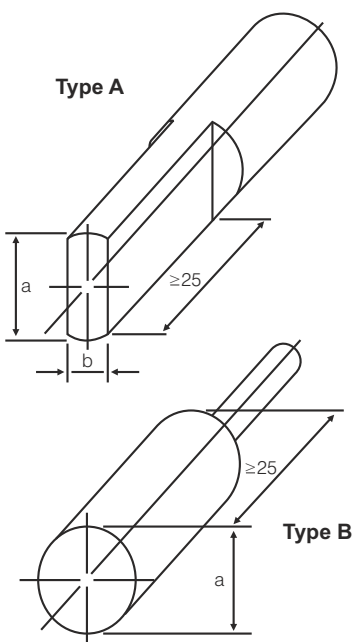

Representative Picture of Gauge Type A and Type B

Conductor Cross-section

Flexible (sq.mm)	Rigid (solid or stranded) (sq.mm)	Gauge Type A			Gauge Type B		Permissible deviation for a and b
		Marking	Diameter a (mm)	Width b (mm)	Marking	Diameter a (mm)	
1.5	1.5	A1	2.4	1.5	B1	1.9	0 / -0.05
2.5	2.5	A2	2.8	2.0	B2	2.4	0 / -0.05
2.5	4	A3	2.8	2.4	B3	2.7	0 / -0.05
4	6	A4	3.6	3.1	B4	3.5	0 / -0.06
6	10	A5	4.3	4.0	B5	4.4	0 / -0.06
10	16	A6	5.4	5.1	B6	5.3	0 / -0.06
16	25	A7	7.1	6.3	B7	6.9	0 / -0.07
25	35	A8	8.3	7.8	B8	8.2	0 / -0.07
35	50	A9	10.2	9.2	B9	10.0	0 / -0.07
50	70	A10	12.3	11.0	B10	12.0	0 / -0.08
70	95	A11	14.2	13.1	B11	14.0	0 / -0.08
95	120	A12	16.2	15.1	B12	16.0	0 / -0.08
120	150	A13	18.2	17.0	B13	18.0	0 / -0.08
150	185	A14	20.2	19.0	B14	20.0	0 / -0.08
185	240	A15	22.2	21.0	B15	22.0	0 / -0.09
240	300	A16	26.5	24.0	B16	26.0	0 / -0.09

ELECTRICAL DATA

Connectwell Terminal Blocks are standard blocks for industries such as Switchgear, Distribution, Machine Tools Control, Instrumentation Installations, Material Handling Equipments, Process Plants On and Offshore Installations and Panel Board Construction.

Rated Voltage

The voltage rating of the product is assigned in accordance with specifications related to Creepage & Clearance distance defined in respective EN, VDE, UL and CSA standards, for the environmental conditions and pollution degrees as given below.

Degree of Pollution

- Pollution degree 1** No pollution or only dry, non-conductive pollution occurs. The pollution has no influence.
- Pollution degree 2** Only non-conductive pollution occurs except that occasionally a temporary conductivity caused by condensation is to be expected.
- Pollution degree 3** Conductive pollution occurs or dry, non conductive pollution occurs which becomes conductive due to condensation is to be expected.
- Pollution degree 4** The pollution generates persistent conductivity caused by conductive dust or by rain or snow.

Rated Impulse Voltage

The rated impulse voltage of the product is the peak value of an impulse voltage with which the terminal block can be loaded and on which the creepage and clearances according to relevant standard are based.

CTI - Comparative Tracking Index of Insulation material

The insulation material is divided into four groups according to their CTI (Comparative Tracking Index)

Material Group I	600 ≤ CTI
Material Group II	400 ≤ CTI < 600
Material Group III a	175 ≤ CTI < 400
Material Group III b	100 ≤ CTI < 175

The Comparative Tracking Index must be defined according to DIN IEC 112/ VDE 0303 part 1 on specimens made specifically for this purpose with test solution A. The proof-tracking index (PTI) is also used to identify the tracking characteristics of materials. A material may be included in one of the four groups given above on the basis that its PTI, established by the method of IEC 112 using solution A, is equal to or greater than the lower value specified for the Insulation group.

Current carrying capacity of terminal block (DIN EN 60947-7-1/VDE 0611part1: 2000-05)

The data given below is for unprepared conductor ends without ferrules. The rated current for Terminal Blocks with specific functions such as Fuse type, Relays, Terminal Blocks incorporating electronic components is to be specified by manufacturer.

Rated Cross Section (sq.mm)	0.2	0.5	0.75	1	1.5	2.5	4	6	10	16	25	35	50	70	95	120	150	185	240	300
Test current (A)	4	6	9	13.5	17.5	24	32	41	57	76	101	125	150	192	232	269	309	353	415	520

Current Rating with two wire/conductors

The total current of the two wires / conductors should not exceed the continuous current rating of the Terminal Block. The continuous current rating is the maximum current the terminal block can conduct without a temperature rise of 45 K (as per EN standard) and 30°C (as per UL / CSA standard).

Note

For PE-Terminals only one conductor should be connected per clamping part, in accordance with installation requirement.

TERMINAL BLOCK MATERIAL

Connectwell Terminal Blocks are made of carefully selected materials, insulating materials, clamping and conducting metals which are subject to strict quality control as demanded by the most stringent international standards.

Clamping Screws

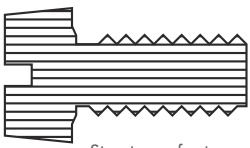

Structure of a turned Screw

One of the most important parts of the terminal block is its screw. The quality of the connection depends mainly on the quality of the screw. The screw must not get damaged, should withstand a higher torque than what is stipulated in its specification. The screw should not, even at the highest stress weld with the metal of the main thread.

Connectwell Terminal Blocks employ cold forged rolled threaded steel screws. In such screws the material is compressed and therefore strengthened. Whereas, when turned screws are cut, the material from between the threads is removed. Because of this and the stress concentration on the neck of the screw, the turned screw is considerably weaker on strength.

The screws are zinc plated and chromate passivated for a good galvanic surface.

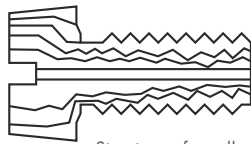

Structure of a rolled Screw

Clamping yoke

Clamping yokes in carefully selected grades of steel ensure high torque performance necessary for gas tight connections. The clamping components (both screws and clamping yokes) are electroplated with zinc and passivated by an additional coat of chromate. The Zinc provides a cathodic protection to the steel. Therefore the effect of protection against corrosion is still retained even when the plating is partially damaged by scratches or pores.

The clamping components of some of Connectwells Terminal Blocks are made of copper alloys. Such components are electroplated with either nickel or tin to ensure oxidation free performance.

Current carrying / Conducting components

The current carrying/conducting components / current bars are made of electrolytic grade copper or copper alloy to ensure very low contact resistance. The components are electroplated with tin / nickel to provide an oxidation free contact.

Insulating Material

All the live parts in Terminal Blocks are totally shrouded to minimize the risk of accidental contact in High Grade Melamine or in Engineering Thermoplastic Polyamide 6.6 Housing.

High Grade Melamine

Melamine is a thermosetting material of the amino group of plastics. Apart from its inherent dielectric properties, it retains its mechanical, electrical and dimensional stability under conditions of heat, cold, damp and dryness to a degree in excess of commercial thermoplastic and phenolic material. It has very good insulation properties and a high resistance to flash over. Since its material is of eroding type rather than carbonising type, its resistance to tracking is also high. The moulded housing is non-hygroscopic, not subject to mould growth, is completely reliable in tropical conditions and can be used in a temperature range of - 55°C to + 130°C.

TERMINAL BLOCK MATERIAL

Polyamide 6.6

Engineering Thermoplastic Polyamide 6.6 has excellent electrical, mechanical and chemical characteristics, even at temperature as high as 105°C. This insulating material has high mechanical strength - it is unbreakable. Its resistance to tracking is similar to Melamine. The Polyamide 6.6 moulded housing absorbs humidity from its surroundings. However, it does not crystallise water in the plastic itself as is the case in thermosetting plastic. The H₂O groups combine within the molecular structure.

Thus moulded plastic housing becomes fracture proof and unbreakable even in sub zero temperature conditions.

Polyamide 6.6 is difficult to ignite, self-extinguishing, burns only as long as there is a supporting flame and is rated V2 according to UL 94. It has excellent resistance to micro organisms, bacteria, enzymes and termites. Good ageing resistance and insensitivity to ultra violet light makes it suitable for tropical and open air applications. Polyamide 6.6 has excellent resistance to fuels, oils, fats and most common solvents like aliphatic and aromatic carbohydrates, ketons and alcohols.

Typical properties of insulation material

Property	Unit	Thermoset High Grade Melamine	Engineering Thermoplastic Polyamide 6.6
Specific Gravity	-	1.5	1.2 - 1.15
Upper Temperature Limit	°C	130	105
Lower Temperature Limit	°C	- 55	- 50
Volume Resistivity	Ohm cm	10 ¹¹	10 ¹²
Surface Resistivity	Ohm	10 ¹⁰	10 ¹⁰
Dielectric Strength	KV/cm	100	400
Tropical Resistance	-	Good	Good
Flammability	Grade	V0	V2 / V0 #
Flexibility	-	-	Excellent

V0 available on request

CE Marking

The CE marking is, in particular, an indication that the products comply with the essential requirements of applicable directives and that the products have been subject to a conformity assessment procedure provided for in the directives. CE marking ensures free trading within Europe. Connectwell terminal blocks are CE marked and the products comply to Low Voltage Directive, 73/23/EEC, Including amendments by the CE marking directive, 93/68/EEC

At Connectwell the Product Development cycle, production & assembly of components and supply are all controlled by an ISO 9001:2015 Quality Management System.

Connectwell Products not only fulfill Customers needs and requirements of standards and specifications but also surpass the same.

TECHNICAL INFORMATION









FUSE TERMINAL BLOCKS

Max. power dissipation with Reference IEC 60947-7-3

When selecting Cartridge fuse inserts, please ensure that the maximum power dissipation specified below is not exceeded. Details can be obtained from the fuse manufacturers.

Cartridge fuse inserts 5 X 20 mm

Terminal Block	Rated Voltage (V)	Rated Current (I _{max})	Exclusive short circuit protection	
			Separate Arrangement	Compound Arrangement
CXF4	1000	10	2W	2W
CXF4L	1000	10	2W	2W
CXCC4-CPF	1000	10	2W	2W
CXCC4-CPFL	1000	10	2W	2W
CYDLGF4LRL	500	10	2W	2W
CYDLGF4LRL	500	10	2W	2W
CYDLGF4LRL	500	10	2W	2W
CYDLF4LR	500	10	2W	2W
CYDLGF4L	500	10	2W	2W
CYDLF4L	500	10	2W	2W
CYDLGF4	500	10	2W	2W
CYDLF4	500	10	2W	2W
CXF4/3	1000	10	2W	2W
CXF4/3L	1000	10	2W	2W
CXAF4/3	1000	10	2W	2W
CXCC4/3-CPF	1000	10	2W	2W
CXCC4/3-CPFL	1000	10	2W	2W
CXVFA	800	10	2W	2W
CXVF2.5A	800	10	2W	2W

Index	Cat. No.	Pg. No.	Cat. No.	Pg. No.	Cat. No.	Pg. No.
The Index gives ready reference of Cat. No. / Type and cross reference of page number.	AGT2.5	85	CA501-2M-S	263	CA509/K9FWHT	268
Abbreviation used:	AGT2.5/3	86	CA502	264	CA509/K9WHT	268
Colour	AGT2.5/4	87	CA502/F	257	CA510/01	278
Ordering Suffix	AGT4	86	CA503/01	278	CA510/1	278
Blue 	AGT4/3	87	CA503/1	278	CA510/5	278
Black 	AGT4/4	88	CA503/5	278	CA512/10-2	278
Orange 	AGT6	86	CA504/01	278	CA512/10-3	278
Red 	AGT6/3	88	CA504/1	278	CA512/10-4	278
Green 	AS2.5	81	CA504/5	278	CA512/11-2	277
Yellow 	AS2.5/3	82	CA505/01	278	CA512/1-2	277
White 	AS2.5/3BK	82	CA505/1	278	CA512/12-2	278
Beige 	AS2.5/3BU	82	CA505/5	278	CA512/1-3	277
	AS2.5/3GN	82	CA506/01	278	CA512/13-2	277
	AS2.5/3R	82	CA506/1	278	CA512/13-3	277
	AS2.5/3Y	82	CA506/5	278	CA512/13-4	277
	AS2.5/4	83	CA507/L/Q/01	278	CA512/1-4	277
	AS2.5/4BK	83	CA507/S/Q/01	278	CA512/14-2	278
	AS2.5/4BU	83	CA508/L/Q	278	CA512/14-3	278
	AS2.5/4GN	83	CA508/S/Q	278	CA512/14-4	278
	AS2.5/4R	83	CA509/7	257	CA512/15-2	277
	AS2.5/4Y	83	CA509/G1	265	CA512/15-3	277
	AS2.5BK	81	CA509/G2	265	CA512/15-4	277
	AS2.5BU	81	CA509/K10/H	268	CA512/17-2	278
	AS2.5GN	81	CA509/K10/V	268	CA512/17-3	278
	AS2.5R	81	CA509/K10WHT	268	CA512/17-4	278
	AS2.5Y	81	CA509/K12/H	268	CA512/2-2	277
	AS4	82	CA509/K12/V	268	CA512/2-3	277
	AS4/3	83	CA509/K12WHT	268	CA512/2-4	277
	AS4/3BK	83	CA509/K16/H	268	CA512/3-2	278
	AS4/3BU	83	CA509/K16/V	268	CA512/3-3	278
	AS4/3GN	83	CA509/K16WHT	268	CA512/3-4	278
	AS4/3R	83	CA509/K2/H	268	CA512/4-2	278
	AS4/3Y	83	CA509/K2/V	268	CA512/4-3	278
	AS4/4	84	CA509/K2B4/H	268	CA512/4-4	278
	AS4/4BK	84	CA509/K2B4/V	268	CA512/5-2	277
	AS4/4BU	84	CA509/K2B4WHT	268	CA512/5-3	277
	AS4/4GN	84	CA509/K2G/H	268	CA512/5-4	277
	AS4/4R	84	CA509/K2G/V	268	CA512/6-2	278
	AS4/4Y	84	CA509/K2GWHT	268	CA512/6-3	278
	AS4BK	82	CA509/K2WHT	268	CA512/6-4	278
	AS4BU	82	CA509/K3.5WHT	268	CA512/7-2	277
	AS4GN	82	CA509/K3/H	268	CA512/7-3	277
	AS4R	82	CA509/K3/V	268	CA512/7-4	277
	AS4Y	82	CA509/K3WHT	268	CA512/8-2	278
	AS6	82	CA509/K4/H	268	CA512/8-3	278
	AS6/3	84	CA509/K4/V	268	CA512/8-4	278
	AS6/3BK	84	CA509/K4WHT	268	CA512/9-2	277
	AS6/3BU	84	CA509/K5/H	268	CA512/9-3	277
	AS6/3GN	84	CA509/K5/V	268	CA512/9-4	277
	AS6/3R	84	CA509/K5WHT	268	CA513	257
	AS6/3Y	84	CA509/K6/H	268	CA514/10-2	278
	AS6BK	82	CA509/K6/V	268	CA514/10-3	278
	AS6BU	82	CA509/K6F/H	268	CA514/10-4	278
	AS6GN	82	CA509/K6F/V	268	CA514/11-2	277
	AS6R	82	CA509/K6FWHT	268	CA514/1-2	277
	AS6Y	82	CA509/K6WHT	268	CA514/12-2	278
	AUX6	140	CA509/K7.5/H	268	CA514/1-3	277
	CA102	264	CA509/K7.5/V	268	CA514/13-2	277
	CA103	264	CA509/K7.5WHT	268	CA514/13-3	277
	CA104	264	CA509/K8/H	268	CA514/13-4	277
	CA202	264	CA509/K8/V	268	CA514/1-4	277
	CA302	264	CA509/K8WHT	268	CA514/14-10	278
	CA402	264	CA509/K9/H	268	CA514/14-2	278
	CA501-1M	263	CA509/K9/V	268	CA514/14-3	278
	CA501-1M-S	263	CA509/K9F/H	268	CA514/14-3A	278
	CA501-2M	263	CA509/K9F/V	268	CA514/14-4	278

When ordering please add colour suffix to Cat. No.

Example: CTS2.5UNR

Note:

Colours given above are indicative purpose only.

Contact us for colour products that are not listed in Alphabetical index.

Cat. No.	Pg. No.	Cat. No.	Pg. No.	Cat. No.	Pg. No.	Cat. No.	Pg. No.
CA514/14-4A	278	CA627/3	275	CA707/S/Q/3	274	CA741/10	273
CA514/15-2	277	CA627/4	275	CA710/10	274	CA741/100	273
CA514/15-3	277	CA628/2	275	CA710/2	274	CA741/2	273
CA514/15-4	277	CA628/3	275	CA710/3	274	CA741/3	273
CA514/17-2	278	CA629/2	275	CA710/4	274	CA741/4	273
CA514/17-3	278	CA629/3	275	CA713/10	274	CA742/10	273
CA514/17-4	278	CA643/10	275	CA713/2	274	CA742/100	273
CA514/2-2	277	CA643/2	275	CA713/3	274	CA742/2	273
CA514/2-3	277	CA643/3	275	CA713/4	274	CA742/3	273
CA514/2-4	277	CA643/4	275	CA715/10	276	CA742/4	273
CA514/3-2	278	CA644/10	275	CA715/2	276	CA743/10	273
CA514/3-3	278	CA644/2	275	CA715/3	276	CA743/2	273
CA514/3-4	278	CA644/3	275	CA715/4	276	CA743/3	273
CA514/4-2	278	CA644/4	275	CA717/10	274	CA743/4	273
CA514/4-3	278	CA645/10	275	CA717/2	274	CA744/10	273
CA514/4-4	278	CA645/2	275	CA717/3	274	CA744/2	273
CA514/5-2	277	CA645/3	275	CA717/4	274	CA744/3	273
CA514/5-3	277	CA645/4	275	CA718/10	274	CA744/4	273
CA514/5-4	277	CA701-15-1M	263	CA718/2	274	CA745/10	273
CA514/6-2	278	CA701-15-1M-S	263	CA718/3	274	CA745/2	273
CA514/6-3	278	CA701-15-2M	263	CA718/4	274	CA745/3	273
CA514/6-4	278	CA701-15-2M-S	263	CA721/10	273	CA745/4	273
CA514/7-2	277	CA701-1M	263	CA721/100	273	CA747/10	273
CA514/7-3	277	CA701-1M-S	263	CA721/2	273	CA747/2	273
CA514/7-4	277	CA701-2M	263	CA721/3	273	CA747/3	273
CA514/8-2	278	CA701-2M-S	263	CA721/4	273	CA747/4	273
CA514/8-3	278	CA701-AL-1M	263	CA722/10	273	CA749/10	273
CA514/8-4	278	CA702	264	CA722/100	273	CA749/2	273
CA514/9-2	277	CA703	266	CA722/2	273	CA749/3	273
CA514/9-3	277	CA703/01	274	CA722/3	273	CA749/4	273
CA514/9-4	277	CA703/1	274	CA722/4	273	CA751/10	273
CA521/10	277	CA703/10	274	CA723/10	273	CA751/2	273
CA521/2	277	CA703/11	275	CA723/2	273	CA751/3	273
CA521/3	277	CA703/2	274	CA723/3	273	CA751/4	273
CA521/4	277	CA703/3	274	CA723/4	273	CA761/10	273
CA522/10	277	CA703/4	274	CA724/10	273	CA761/2	273
CA522/2	277	CA703/6	274	CA724/2	273	CA761/3	273
CA522/3	277	CA703/8	274	CA724/3	273	CA761/4	273
CA522/4	277	CA703/9	275	CA724/4	273	CA770/10	274
CA601-1M	263	CA704/01	274	CA725/10	273	CA771/10	273
CA602	264	CA704/1	274	CA725/2	273	CA771/2	273
CA603	266	CA704/10	274	CA725/3	273	CA771/3	273
CA607/S/Q	274	CA704/11	275	CA725/4	273	CA771/4	273
CA611/S/Q	276	CA704/2	274	CA727/10	273	CA772/10	275
CA621/10	277	CA704/3	274	CA727/2	273	CA772/2	275
CA621/2	277	CA704/4	274	CA727/3	273	CA772/3	275
CA621/3	277	CA704/6	274	CA727/4	273	CA772/4	275
CA621/4	277	CA704/8	274	CA728/10	275	CA773/10	275
CA622/10	277	CA704/9	275	CA728/2	275	CA773/2	275
CA622/2	277	CA705/01	274	CA728/3	275	CA773/3	275
CA622/3	277	CA705/1	274	CA728/4	275	CA773/4	275
CA622/4	277	CA705/10	274	CA729/10	273	CA774/2	275
CA623/10	275	CA705/11	275	CA729/2	273	CA774/3	275
CA623/2	275	CA705/2	274	CA729/3	273	CA774/4	275
CA623/3	275	CA705/3	274	CA729/4	273	CA781/10	273
CA623/4	275	CA705/4	274	CA731/10	274	CA781/2	273
CA624/10	275	CA705/6	274	CA731/100	274	CA781/3	273
CA624/2	275	CA705/8	274	CA731/10-A	274	CA781/4	273
CA624/3	275	CA705/9	275	CA732/10	274	CA801/1	279
CA624/4	275	CA706/2	278	CA732/100	274	CA801/1-3	279
CA625/10	275	CA706/3	278	CA732/10-A	274	CA801/2	279
CA625/2	275	CA706/8	278	CA733/10	274	CA801/2-3	279
CA625/3	275	CA707/L/Q/1	278	CA734/10	274	CA801/3	279
CA625/4	275	CA707/S/Q/01	274	CA735/10	274	CA801/3-3	279
CA627/10	275	CA707/S/Q/1	274	CA737/10	274	CA801/5	279
CA627/2	275	CA707/S/Q/2	274	CA739/10	274	CA801/8	279

Cat. No.	Pg. No.	Cat. No.	Pg. No.	Cat. No.	Pg. No.	Cat. No.	Pg. No.
CA802	264	CBS5UY	216	CDL4UERC0.22MF	208	CGT4N	152
CA803	266	CC14	159	CDL4UERCO-0.1MF	208	CGT4U	152
CA803/1	279	CC2.5D	94	CDL4UESDB-160V	208	CGT50/70N	155
CA901/1	279	CC2.5R0.5	94	CDL4UESDUA24V	208	CGT50/70NA	155
CA901/2	279	CC2.5R1	94	CDL4UN	145	CGT6N	153
CA901/3	279	CC2.5R1.5	94	CDL4UN(I.S)	145	CHV10U	192
CA901/4	279	CC20	159	CDL4UN(I.S)BK	145	CHV10UBU	192
CA901/5	279	CC35	159	CDL4UN(I.S)BU	145	CHV4U	191
CA902	267	CC6D	32	CDL4UN(I.S)GN	145	CHV4UBU	191
CA903	266	CC6F	32	CDL4UN(I.S)O	145	CHV6U	192
CAFL4UBK	162	CC6FL110-240V	32	CDL4UN(I.S)R	145	CHV6UBU	192
CAFL4UBU	162	CC6FL6-60V	32	CDL4UN(I.S)W	145	CIP	95
CAFL4UL110V	162	CC6R	32	CDL4UN(I.S)Y	145	CKT4SP	166
CAFL4UL220V	162	CC8	159	CDL4UNBK	145	CKT4SPBU	166
CAFL4UL24V	162	CCC4U	189	CDL4UNBU	145	CKT4SPSC	195
CAFL4UL48V	162	CCS10-20	160	CDL4UNGN	145	CKT4U	165
CAFL4UN110V	162	CCS15-32	160	CDL4UNO	145	CKT4U/4	166
CAFL4UN220V	162	CCS2X2-6	160	CDL4UNR	145	CKT4U/4BU	166
CAFL4UW/F	162	CCS3-8	160	CDL4UNSP	266	CKT4U/S	165
CASP	266	CCS4 -13.5	160	CDL4UNW	145	CKT4UBU	165
CB16/2H	260	CDB10/2	180	CDL4UNY	145	CKT4UD1	204
CB16/3H	260	CDB10/3	180	CDL4USP	266	CKT4UD2	204
CB4/	259	CDB10/4	180	CDLG2.5	147	CKT4UH	165
CB4/2	259	CDB25/1	181	CDLG4	146	CKT6U	167
CB4/2H	259	CDB25/2	181	CDLG4(I.S)	146	CKT6UBU	167
CB4/3	259	CDB25/3	181	CDS4U	171	CLM011	272
CB4/3H	259	CDB25/4	181	CDS6U	172	CLP35/2	187
CB6/1	260	CDB4/1	179	CDS6U/FT	172	CLP35/2A	188
CB6/2H	260	CDB4/10(1)	180	CDS6U/SC	173	CM1.5S	89
CB6/3H	260	CDB4/11(1)	180	CDS6U/TS	172	CM1.5S2	90
CB6/4H	260	CDB4/2	179	CDS6UBU	172	CM1.5S2BK	90
CBB120	232	CDB4/2(1)	180	CDTTU	169	CM1.5S2BU	90
CBB120LS	232	CDB4/3	179	CDTTUBU	169	CM1.5S2GN	90
CBB150	233	CDB4/3(1)	180	CDTTUFT	170	CM1.5S2O	90
CBB150LS	233	CDB4/4	179	CDTTUFTBU	170	CM1.5S2R	90
CBB185	234	CDB4/4(1)	180	CDTTUFTSC	196	CM1.5S2Y	90
CBB185LS	234	CDB4/5	179	CDTTUSC	196	CM1.5S2YG	90
CBB35/50	231	CDB4/5(1)	180	CDTTUSH	170	CM1.5SBK	89
CBB35/50LS	231	CDB4/6	179	CENC35	158	CM1.5SBU	89
CBB70	232	CDB4/6(1)	180	CENC35BK	158	CM1.5SGN	89
CBB70LS	232	CDB6/1	180	CENC35BU	158	CM1.5SO	89
CBB95	232	CDB6/2	180	CENC35G	158	CM1.5SR	89
CBB95LS	232	CDB6/3	180	CENC4	158	CM1.5SY	89
CBDT4U	223	CDB6/4	180	CENC4BK	158	CM1.5SYG	89
CBDT4UBK	223	CDL4U(O)	205	CENC4BU	158	CM2.5S	90
CBDT4UBU	223	CDL4UE3LA(90V)	207	CENC4G	158	CM2.5S2	90
CBDT4UGN	223	CDL4UED1	203	CF4SP	162	CM2.5S2BK	90
CBDT4UNS	224	CDL4UED2	203	CF4SPBK	162	CM2.5S2BU	90
CBDT4UNSE	224	CDL4UED3	203	CF4SPBU	162	CM2.5S2GN	90
CBDT4UR	223	CDL4UED4	204	CF4SPD1	204	CM2.5S2O	90
CBDT4UY	223	CDL4UEDD1	204	CF4SPD2	204	CM2.5S2R	90
CBS3U	215	CDL4UEDD2	204	CF4SPD3	204	CM2.5S2Y	90
CBS3UBK	215	CDL4UEDD3	204	CF4SPFT	162	CM2.5S2YG	90
CBS3UBU	215	CDL4UEDD4	204	CF4SPFTBU	162	CM2.5SBK	90
CBS3UGN	215	CDL4UEDD5	129	CF4SPL110-240V	162	CM2.5SBU	90
CBS3UR	215	CDL4UEL1	205	CF4SPL6-60V	162	CM2.5SGN	90
CBS3UY	215	CDL4UEL2	205	CF4U	161	CM2.5SO	90
CBS4U	216	CDL4UELA90V	206	CF4UBK	161	CM2.5SR	90
CBS4UBK	216	CDL4UELD1	205	CF4UBU	161	CM2.5SY	90
CBS4UBU	216	CDL4UELD2	205	CF4UL110-240V	161	CM2.5SYG	90
CBS4UGN	216	CDL4UELD3	205	CF4UL6-60V	161	CM4S	91
CBS4UR	216	CDL4UELD4	205	CGMT4	156	CM4S2	91
CBS4UY	216	CDL4UELD5	205	CGT10N	154	CM4S2BK	91
CBS5U	216	CDL4UEMOV-30V	207	CGT10U	154	CM4S2BU	91
CBS5UBU	216	CDL4UEMOV-60V	207	CGT16N	154	CM4S2GN	91
CBS5UR	216	CDL4UEN1	205	CGT35U	155	CM4S2O	91

Cat. No.	Pg. No.	Cat. No.	Pg. No.	Cat. No.	Pg. No.	Cat. No.	Pg. No.
CM4S2R	91	CMST19W	257	CP2.5P/7	104	CP6/10/3BU	14
CM4S2Y	91	CMST2	258	CP2.5P/8	104	CP6/10/3GN	14
CM4S2YG	91	CMST210W	258	CP2.5P/9	104	CP6/10/3R	14
CM4SBK	91	CMST22W	258	CP2.5PD	104	CP6/10/3Y	14
CM4SBU	91	CMST23W	258	CP2.5PD/10	104	CP6/10BK	10
CM4SGN	91	CMST24W	258	CP2.5PD/11	104	CP6/10BU	10
CM4SO	91	CMST25W	258	CP2.5PD/12	104	CP6/10GN	10
CM4SR	91	CMST26W	258	CP2.5PD/13	104	CP6/10R	10
CM4SY	91	CMST27W	258	CP2.5PD/14	104	CP6/10Y	10
CM4SYG	91	CMST28W	258	CP2.5PD/15	104	CP8L32	33
CMB4	199	CMST29W	258	CP2.5PD/2	104	CP8L32(I.S)	34
CMB4BK	199	CMSTPP	281	CP2.5PD/3	104	CP8L32(I.S)BK	34
CMB4BU	199	CMT10	198	CP2.5PD/4	104	CP8L32(I.S)BU	34
CMB4GN	199	CMT4	197	CP2.5PD/5	104	CP8L32(I.S)H	34
CMB4O	199	CMT4BK	197	CP2.5PD/6	104	CP8L32(I.S)R	34
CMB4R	199	CMT4BU	197	CP2.5PD/7	104	CP8L32BK	33
CMB4W	199	CMT4GN	197	CP2.5PD/8	104	CP8L32BU	33
CMB4Y	199	CMT4R	197	CP2.5PD/9	104	CP8L32R	33
CMB6	200	CMT4Y	197	CP2.5PDL	104	CPAF6	37
CMC1-2	141	CMTB35	267	CP2.5PJ	104	CPAF6L12V	37
CMC1-2BU	141	CP1.5	9	CP2.5PJ/10	104	CPAF6L24V	37
CMC2-2	142	CP1.5/3	11	CP2.5PJ/11	104	CPCC6	32
CMC2-2BU	142	CP1.5/3BK	11	CP2.5PJ/12	104	CPD1	95
CMDB10/10	182	CP1.5/3BU	11	CP2.5PJ/13	104	CPDL1.5	20
CMDB10/2	182	CP1.5/3GN	11	CP2.5PJ/14	104	CPDL1.5(I.S)	21
CMDB10/3	182	CP1.5/3R	11	CP2.5PJ/15	104	CPDL1.5BK	20
CMDB10/4	182	CP1.5/3Y	11	CP2.5PJ/2	104	CPDL1.5BU	20
CMDB12	183	CP1.5/4	12	CP2.5PJ/3	104	CPDL1.5GN	20
CMDB25/10	182	CP1.5/4BK	12	CP2.5PJ/4	104	CPDL1.5R	20
CMDB25/2	182	CP1.5/4BU	12	CP2.5PJ/5	104	CPDL1.5Y	20
CMDB25/3	182	CP1.5/4GN	12	CP2.5PJ/6	104	CPDL2.5	22
CMDB25/4	182	CP1.5/4R	12	CP2.5PJ/7	104	CPDL2.5(E)D1	43
CMDB4/10	181	CP1.5/4Y	12	CP2.5PJ/8	104	CPDL2.5(E)D2	43
CMDB4/2	181	CP1.5BK	9	CP2.5PJ/9	104	CPDL2.5(E)D3	43
CMDB4/3	181	CP1.5BU	9	CP2.5PJL	104	CPDL2.5(E)DD1	44
CMDB4/4	181	CP1.5GN	9	CP2.5PL	104	CPDL2.5(E)DD2	44
CMDB6/10	182	CP1.5R	9	CP2.5R	10	CPDL2.5(E)DD3	44
CMDB6/2	182	CP1.5Y	9	CP2.5Y	10	CPDL2.5(E)DD4	44
CMDB6/3	182	CP2.5	10	CP4	10	CPDL2.5(E)DD5	44
CMDB6/4	182	CP2.5/3	12	CP4/3	13	CPDL2.5(E)DD6	44
CMDT4	251	CP2.5/3BK	12	CP4/3BK	13	CPDL2.5(E)LD1	44
CMDT4BK	251	CP2.5/3BU	12	CP4/3BU	13	CPDL2.5(E)TS1	44
CMDT4BU	251	CP2.5/3GN	12	CP4/3GN	13	CPDL2.5(I.S)	22
CMDT4R	251	CP2.5/3R	12	CP4/3R	13	CPDL2.5BK	22
CMDT4S	252	CP2.5/3Y	12	CP4/3Y	13	CPDL2.5BU	22
CMDT4SH	252	CP2.5/4	12	CP4/4	13	CPDL2.5GN	22
CMDT4SHBK	252	CP2.5/4BK	12	CP4/4(E)D1	45	CPDL2.5R	22
CMDT4SHBU	252	CP2.5/4BU	12	CP4/4(E)D2	45	CPDL2.5Y	22
CMDT4SHR	252	CP2.5/4GN	12	CP4/4(E)D3	45	CPDL4	24
CMDT4SHY	252	CP2.5/4R	12	CP4/4(E)D4	45	CPDL4(I.S)	24
CMDT4Y	251	CP2.5/4Y	12	CP4/4(E1)D3	45	CPDLF2.5	36
CMS2.5	74	CP2.5BK	10	CP4/4(E1)D4	45	CPDLF2.5L110-240V	36
CMS2.5BK	74	CP2.5BU	10	CP4/4BK	13	CPDLF2.5L6-60V	36
CMS2.5BU	74	CP2.5GN	10	CP4/4BU	13	CPDLFK2.5	36
CMS2.5GN	74	CP2.5P	104	CP4/4GN	13	CPDLFK2.5L110-240V	36
CMS2.5R	74	CP2.5P/10	104	CP4/4R	13	CPDLFK2.5L6-60V	36
CMS2.5Y	74	CP2.5P/11	104	CP4/4Y	13	CPDLG1.5	21
CMST1	257	CP2.5P/12	104	CP4BK	10	CPDLG1.5(I.S)	22
CMST110W	257	CP2.5P/13	104	CP4BU	10	CPDLG2.5	23
CMST12W	257	CP2.5P/14	104	CP4GN	10	CPDLG2.5(I.S)	23
CMST13W	257	CP2.5P/15	104	CP4LG2.5	28	CPDLG4	25
CMST14W	257	CP2.5P/2	104	CP4R	10	CPDLG4(I.S)	25
CMST15W	257	CP2.5P/3	104	CP4Y	10	CPDLK2.5	40
CMST16W	257	CP2.5P/4	104	CP6/10	10	CPDLK2.5(I.S)	41
CMST17W	257	CP2.5P/5	104	CP6/10/3	14	CPDLKFT2.5	41
CMST18W	257	CP2.5P/6	104	CP6/10/3BK	14	CPDLKFT2.5(I.S)	42

Cat. No.	Pg. No.	Cat. No.	Pg. No.	Cat. No.	Pg. No.	Cat. No.	Pg. No.
CPF	95	CSB5/N5USH	219	CSTSN4Y	248	CTS10UO	137
CPF4	35	CSB5/N5UY	218	CSTSN5	249	CTS10UR	137
CPF4L110-240V	35	CSC16/3T	57	CSTSN515	249	CTS10USC	194
CPF4L6-60V	35	CSC16/3TBU	57	CSTSN515BK	249	CTS10UW	137
CPF4RO	37	CSC16T	53	CSTSN515BU	249	CTS10UY	137
CPF4ROL110-240V	37	CSC16TBK	53	CSTSN515R	249	CTS10Y	244
CPF4ROL6-60V	37	CSC16TBU	53	CSTSN515Y	249	CTS16	244
CPF6	36	CSC16TGN	53	CSTSN5BK	249	CTS16BK	244
CPF6L110-240V	36	CSC16TR	53	CSTSN5BU	249	CTS16BU	244
CPF6L6-60V	36	CSC16TY	53	CSTSN5R	249	CTS16R	244
CPFL110-240V	95	CSCG16/3T	57	CSTSN5U	220	CTS16U	137
CPFL6-60V	95	CSCG16T	60	CSTSN5UBK	220	CTS16UBK	137
CPG1.5	15	CSCP2.5T	92	CSTSN5UBU	220	CTS16UBU	137
CPG1.5/3	17	CSCP2.5T2	92	CSTSN5UGN	220	CTS16UGN	137
CPG1.5/4	17	CSCP2.5T2BK	92	CSTSN5UR	220	CTS16UR	137
CPG2.5	16	CSCP2.5T2BU	92	CSTSN5UY	220	CTS16UY	137
CPG2.5/3	18	CSCP2.5T2GN	92	CSTSN5Y	249	CTS16Y	244
CPG2.5/4	18	CSCP2.5T2R	92	CSTSN6	250	CTS2.5	243
CPG4	16	CSCP2.5T2Y	92	CSTSN6BK	250	CTS2.5BK	243
CPG4/3	18	CSCP2.5TBK	92	CSTSN6BU	250	CTS2.5BU	243
CPG4/4	19	CSCP2.5TBU	92	CSTSN6R	250	CTS2.5R	243
CPG6/10	16	CSCP2.5TGN	92	CSTSN6U	220	CTS2.5UE	136
CPG6/10/3	19	CSCP2.5TR	92	CSTSN6UBK	220	CTS2.5UEBK	136
CPK2.5	38	CSCP2.5TY	92	CSTSN6UBU	220	CTS2.5UEBU	136
CPK2.5BU	38	CSDL4U	178	CSTSN6UE	221	CTS2.5UEGN	136
CPK4	39	CSE5U	222	CSTSN6UGN	220	CTS2.5UEO	136
CPK4BU	39	CSN6	221	CSTSN6UR	220	CTS2.5UER	136
CPK6	39	CSP1	282	CSTSN6USH	220	CTS2.5UEW	136
CPPT2.5/3	30	CSP2	282	CSTSN6USHBK	220	CTS2.5UEY	136
CPPT2.5/4	31	CSST10	238	CSTSN6USHBU	220	CTS2.5UN	135
CPPTG2.5/4	31	CSST4	237	CSTSN6USHR	220	CTS2.5UNBK	135
CPST1.5/3	29	CSST8	238	CSTSN6USHY	220	CTS2.5UNBU	135
CPST1.5/3L	29	CSTD5	238	CSTSN6UY	220	CTS2.5UNGN	135
CPST1.5/4	30	CSTDE	239	CSTSN6Y	250	CTS2.5UNO	135
CPST1.5/4L	30	CSTDE2	239	CSTSP	281	CTS2.5UNR	135
CPSTG1.5/4	30	CSTSB3	246	CSTSRP	280	CTS2.5UNW	135
CPSTG1.5/4L	30	CSTSB3BK	246	CSTSRN5	250	CTS2.5UNY	135
CPTL2.5	26	CSTSB3BU	246	CSTSRN5BK	250	CTS2.5Y	243
CPTL2.5(I.S)	27	CSTSB3R	246	CSTSRN5BU	250	CTS25UN	138
CPTL2.5BU	26	CSTSB3Y	246	CSTSRN5R	250	CTS25UNBK	138
CPTLG2.5	27	CSTSB4/N4	247	CSTSRN5Y	250	CTS25UNBU	138
CPTLG2.5(I.S)	28	CSTSB4/N4BK	247	CSTSRN6	250	CTS25UNGN	138
CSB3/N3U	216	CSTSB4/N4BU	247	CSTSRN6BK	250	CTS25UNR	138
CSB3/N3UBK	216	CSTSB4/N4R	247	CSTSRN6BU	250	CTS25UNY	138
CSB3/N3UBU	216	CSTSB4/N4Y	247	CSTSRN6R	250	CTS35	245
CSB3/N3UGN	216	CSTSB5	247	CSTSRN6Y	250	CTS35BK	245
CSB3/N3UL	217	CSTSB5BK	247	CTC4U	202	CTS35BU	245
CSB3/N3ULBK	217	CSTSB5BU	247	CTL2.5U	147	CTS35L	252
CSB3/N3ULBU	217	CSTSB5R	247	CTL2.5U(I.S)	148	CTS35LS	252
CSB3/N3ULGN	217	CSTSB5Y	247	CTL2.5UBU	147	CTS35R	245
CSB3/N3ULR	217	CSTSEP2	280	CTL2.5UH	148	CTS35UN	138
CSB3/N3ULY	217	CSTSN4	248	CTL2.5UH(I.S)D2	148	CTS35UNA	138
CSB3/N3UR	216	CSTSN415	248	CTL2.5UHBU	148	CTS35UNABK	138
CSB3/N3USH	217	CSTSN415BK	248	CTL2.5UHL	149	CTS35UNABU	138
CSB3/N3UY	216	CSTSN415BU	248	CTL2.5UL	149	CTS35UNAGN	138
CSB4/N4UN	218	CSTSN415R	248	CTLG2.5	150	CTS35UNAR	138
CSB4/N4UNBU	218	CSTSN415Y	248	CTLG2.5EMOV-275V	208	CTS35UNAY	138
CSB4/N4UNR	218	CSTSN4BK	248	CTS10	244	CTS35UNBK	138
CSB4/N4UNY	218	CSTSN4BU	248	CTS10BK	244	CTS35UNBU	138
CSB4/N4USH	218	CSTSN4R	248	CTS10BU	244	CTS35UNGN	138
CSB4/N4USHBK	218	CSTSN4U	219	CTS10R	244	CTS35UNR	138
CSB5/N5U	218	CSTSN4UBK	219	CTS10SC	256	CTS35UNY	138
CSB5/N5UBK	218	CSTSN4UBU	219	CTS10U	137	CTS35Y	245
CSB5/N5UBU	218	CSTSN4UGN	219	CTS10UBK	137	CTS4SC	255
CSB5/N5UGN	218	CSTSN4UR	219	CTS10UBU	137	CTS4UN	136
CSB5/N5UR	218	CSTSN4UY	219	CTS10UGN	137	CTS4UNBK	136

Cat. No.	Pg. No.	Cat. No.	Pg. No.	Cat. No.	Pg. No.	Cat. No.	Pg. No.
CTS4UNBU	136	CTSPC1(70mm)	282	CX2.5SN/12	103	CXDL2.5/2B(I.S)	102
CTS4UNGN	136	CTSPC1(760mm)	282	CX2.5SN/13	103	CXDL2.5/3	67
CTS4UNO	136	CTSP01	281	CX2.5SN/14	103	CXDL2.5/3(I.S)	68
CTS4UNR	136	CTSP1B	281	CX2.5SN/15	103	CXDL2.5BK	65
CTS4UNW	136	CTSP1L	281	CX2.5SN/2	103	CXDL2.5BU	65
CTS4UNY	136	CTSP1SC	281	CX2.5SN/3	103	CXDL2.5GN	65
CTS4USC	193	CTSP2	281	CX2.5SN/4	103	CXDL2.5R	65
CTS4USCBU	193	CTSP3	281	CX2.5SN/5	103	CXDL2.5Y	65
CTS50/70N	139	CTT2.5UE	201	CX2.5SN/6	103	CXDLG2.5	66
CTS50/70NA	139	CTT2.5UJ	201	CX2.5SN/7	103	CXDLG2.5(I.S)	66
CTS50/70NABK	139	CTT2.5UK	201	CX2.5SN/8	103	CXDLG2.5/2B	101
CTS50/70NABU	139	CTT2.5UT	201	CX2.5SN/9	103	CXDLG2.5/2B(I.S)	102
CTS50/70NAGN	139	CX10/3	57	CX2.5Y	52	CXDLG2.5/3	68
CTS50/70NAR	139	CX10/3BK	57	CX35	53	CXDLG2.5/3(I.S)	68
CTS50/70NAY	139	CX10/3BU	57	CX35BU	53	CXF4	69
CTS50/70NBK	139	CX10/3GN	57	CX4	52	CXF4/3	70
CTS50/70NBU	139	CX10/3R	57	CX4/3	56	CXF4/3L110-240V	70
CTS50/70NGN	139	CX10/3Y	57	CX4/3BK	56	CXF4/3L6-60V	70
CTS50/70NR	139	CX2.5	51	CX4/3BU	56	CXF4L110-240V	69
CTS50/70NY	139	CX2.5/1B	99	CX4/3GN	56	CXF4L6-60V	69
CTS6	244	CX2.5/2B	100	CX4/3R	56	CXG10	60
CTS6BK	244	CX2.5/3	54	CX4/3Y	56	CXG10/3	63
CTS6BU	244	CX2.5/3/1B	100	CX4/4	56	CXG2.5	58
CTS6R	244	CX2.5/3BK	54	CX4/4BK	56	CXG2.5/1B	99
CTS6SC	256	CX2.5/3BU	54	CX4/4BU	56	CXG2.5/2B	100
CTS6U	136	CX2.5/3GN	54	CX4/4GN	56	CXG2.5/3	61
CTS6UBK	136	CX2.5/3R	54	CX4/4R	56	CXG2.5/3/1B	100
CTS6UBU	136	CX2.5/3Y	54	CX4/4Y	56	CXG2.5/4	61
CTS6UGN	136	CX2.5/4	55	CX4BK	52	CXG2.5/4/2B	100
CTS6UO	136	CX2.5/4(E)D1	97	CX4BU	52	CXG2.5/4/4B	101
CTS6UR	136	CX2.5/4(E)D2	97	CX4GN	52	CXG35	60
CTS6USC	194	CX2.5/4(E)R1	97	CX4R	52	CXG4	59
CTS6USCBU	194	CX2.5/4(E)R2	97	CX4Y	52	CXG4/3	62
CTS6UW	136	CX2.5/4(E)R3	97	CX6	52	CXG4/4	62
CTS6UY	136	CX2.5/4(E)R4	97	CX6/3	56	CXG6	59
CTS6Y	244	CX2.5/4/2B	100	CX6/3BK	56	CXG6/3	62
CTS70L	254	CX2.5/4/4B	101	CX6/3BU	56	CXK2.5	71
CTS70LS	254	CX2.5/4BK	55	CX6/3GN	56	CXK2.5/4	72
CTS95/120N	140	CX2.5/4BU	55	CX6/3R	56	CXK2.5/4BU	72
CTS95/120NBK	140	CX2.5/4GN	55	CX6/3Y	56	CXK2.5BU	71
CTS95/120NBU	140	CX2.5/4P	55	CX6BK	52	CXK4	72
CTS95/120NGN	140	CX2.5/4R	55	CX6BU	52	CXK4/3	72
CTS95/120NR	140	CX2.5/4Y	55	CX6GN	52	CXK4/3BU	72
CTS95/120NY	140	CX2.5BK	52	CX6R	52	CXK4BU	72
CTS95L	254	CX2.5BU	52	CX6Y	52	CXM2.5	73
CTS95LS	254	CX2.5GN	52	CXAF4/3	70	CXM2.5BK	73
CTSEP1	280	CX2.5PLN	103	CXAF4/3L12V	70	CXM2.5BU	73
CTSEP1SC	280	CX2.5PN	103	CXAF4/3L24V	70	CXM2.5GN	73
CTSEP2	280	CX2.5PN/10	103	CXCC2.5/4	94	CXM2.5R	73
CTSEP3	280	CX2.5PN/11	103	CXCC4	95	CXM2.5Y	73
CTSEP4	281	CX2.5PN/12	103	CXCP2.5	92	CXMG2.5	74
CTSG2.5	151	CX2.5PN/13	103	CXCP2.5/4	93	CXS10	76
CTSG4	152	CX2.5PN/14	103	CXDB35/10	79	CXS2.5	75
CTSPC(100mm)	282	CX2.5PN/15	103	CXDB35/10A	79	CXS2.5BK	75
CTSPC(130mm)	282	CX2.5PN/2	103	CXDL2.5	65	CXS2.5BU	75
CTSPC(150mm)	282	CX2.5PN/3	103	CXDL2.5(E)D1	96	CXS2.5GN	75
CTSPC(200mm)	282	CX2.5PN/4	103	CXDL2.5(E)D2	96	CXS2.5R	75
CTSPC(240mm)	282	CX2.5PN/5	103	CXDL2.5(E)D3	96	CXS2.5Y	75
CTSPC(300mm)	282	CX2.5PN/6	103	CXDL2.5(E)DD1	97	CXS4	76
CTSPC(330mm)	282	CX2.5PN/7	103	CXDL2.5(E)DD2	97	CXS6	76
CTSPC(40mm)	282	CX2.5PN/8	103	CXDL2.5(E)DD3	97	CXSG10	78
CTSPC(430mm)	282	CX2.5PN/9	103	CXDL2.5(E)DD4	97	CXSG2.5	77
CTSPC(460mm)	282	CX2.5R	52	CXDL2.5(E)LD1	97	CXSG4	76
CTSPC(760mm)	282	CX2.5SN	103	CXDL2.5(E)TS1	97	CXSG6	78
CTSPC(90mm)	282	CX2.5SN/10	103	CXDL2.5(I.S)	66	CXVF2.5A	70
CTSPC1(100mm)	282	CX2.5SN/11	103	CXDL2.5/2B	101	CXVF2.5AL12V	70

Cat. No.	Pg. No.	Cat. No.	Pg. No.	Cat. No.	Pg. No.	Cat. No.	Pg. No.
CXVF2.5AL240V	70	CYDL2.5(I.S)	118	CYTLGF2.5FT	124	EPCPPT2.5/3	281
CXVF2.5AL24V	70	CYDL2.5BU	117	CYTLGF2.5L6-60V	124	EPCPTL2.5	281
CXVF2.5AL48V	70	CYDL4	119	DB16	184	EPCSC16T	280
CXVF2.5AL60V	70	CYDL4(I.S)	120	DB16BK	184	EPCSCP2.5T(L&R)	280
CXVF2.5B	70	CYDL4BK	119	DB16BU	184	EPCSTSU	280
CXVF2.5BL12V	70	CYDL4BU	119	DB16GN	184	EPCTC4U	280
CXVF2.5BL240V	70	CYDL4ED1	128	DB16R	184	EPCTL2.5U	280
CXVF2.5BL24V	70	CYDL4ED2	128	DB16Y	184	EPCTL2.5UH	280
CXVF2.5BL48V	70	CYDL4ED3	128	DB35	185	EPCTLG2.5	280
CXVF2.5BL60V	70	CYDL4ED4	129	DB35BK	185	EPCX10	280
CXVF2.5C	70	CYDL4EDD1	129	DB35BU	185	EPCX10/3	280
CXVF2.5CL12V	70	CYDL4EDD2	129	DB35GN	185	EPCX2.5	280
CXVF2.5CL240V	70	CYDL4EDD3	129	DB35R	185	EPCX2.5/3	280
CXVF2.5CL24V	70	CYDL4EDD4	129	DB35Y	185	EPCX2.5/4	280
CXVF2.5CL48V	70	CYDL4EL1	130	DDDL4U	178	EPCX2.5SN	280
CXVF2.5CL60V	70	CYDL4EL2	130	DDDL4UBK	178	EPCX4	280
CXVFA	70	CYDL4ELD1	129	DDDL4UBU	178	EPCX4/3	280
CXVFAL12V	70	CYDL4ELD2	129	DDFL4UE110-240V	163	EPCX4/4	280
CXVFAL240V	70	CYDL4ELD3	129	DDFL4UE110V	163	EPCX6	280
CXVFAL24V	70	CYDL4ELD4	130	DDFL4UE220V	163	EPCX6/3	280
CXVFAL48V	70	CYDL4ELD5	130	DDFL4UE24V	163	EPCXCP2.5	281
CXVFAL60V	70	CYDL4GN	119	DDFL4UE440V	163	EPCXDL2.5	280
CXVFB	70	CYDL4R	119	DDFL4UE48V	163	EPCXDL2.5/3	280
CXVFBL12V	70	CYDLF4	122	DDFL4UE6-60V	163	EPCXM2.5	281
CXVFBL240V	70	CYDLF4FT	122	DDFL4UELR110V	164	EPCXS10	280
CXVFBL24V	70	CYDLF4L110-240V	122	DDFL4UELR220V	164	EPCXS2.5	280
CXVFBL48V	70	CYDLF4L6-60V	122	DDFL4UELR24V	164	EPCXS6	280
CXVFBL60V	70	CYDLF4LR	122	DDFL4UELR440V	164	EPCY2.5/10	281
CXVFC	70	CYDLF4LRL110-240V	122	DDFL4UELR48V	164	EPCYDL2.5/4	281
CXVFCL12V	70	CYDLF4LRL6-60V	122	DDFL4ULRW/F	164	EPDDL4U	280
CXVFCL240V	70	CYDLG2.5	118	DDFL4UW/F	163	EPODL2.5	280
CXVFCL24V	70	CYDLG2.5(I.S)	118	ECAP35/15	263	EPODL4U	280
CXVFCL48V	70	CYDLG4	120	ECAP35/7.5	263	EPSTH3	280
CXVFCL60V	70	CYDLG4(I.S)	120	EP1ODL2.5	280	EPSTH4	280
CY10	110	CYDLGF4	122	EP1ODL4U	280	EPSTH4DT	280
CY10BK	110	CYDLGF4FT	122	EP2.5/4UN	280	EPSTH6	280
CY10BU	110	CYDLGF4L110-240V	122	EP4P	281	EPUSC	280
CY10GN	110	CYDLGF4L6-60V	122	EP6/10U	280	FPCMST	257
CY10R	110	CYDLGF4LR	122	EPAS2.5	280	GMH1	265
CY10Y	110	CYDLGK4	127	EPAS4	280	GMH2	265
CY16	111	CYDLK4	127	EPAS6	280	GMH3	265
CY2.5	109	CYF4	121	EPCAFL4U	280	GMH4	265
CY2.5BK	109	CYF4BK	121	EPCBS3U	280	GMH5	265
CY2.5BU	109	CYF4BU	121	EPCDGL2.5	280	GMH6	265
CY2.5GN	109	CYF4L10-36V	121	EPCDL4UN	280	GMH7	265
CY2.5R	109	CYF4L110-240V	121	EPCDS6U	280	GMH8	265
CY2.5Y	109	CYF4L6-60V	121	EPCDTTU	280	GMH8N	265
CY4	110	CYG10	114	EPCGT4U	280	GMH9	265
CY4/3	115	CYG16	114	EPCKT4U	280	JX1.5/10	279
CY4/3BK	115	CYG2.5	112	EPCKT4U/4	280	JX1.5/2	279
CY4/3BU	115	CYG4	113	EPCM1.5S	280	JX1.5/3	279
CY4/3R	115	CYG4/3	116	EPCM2.5S	280	JX1.5/4	279
CY4/4	116	CYG4/4	116	EPCM4S	280	JX10/2	279
CY4/4BU	116	CYG6	113	EPCMB4	280	JX2.5/10	279
CY4BK	110	CYK2.5	125	EPCMC1-2	280	JX2.5/2	279
CY4BU	110	CYK2.5N	126	EPCMC2-2	280	JX2.5/3	279
CY4GN	110	CYK2.5NFT	126	EPCMDT4	280	JX2.5/4	279
CY4R	110	CYK4	126	EPCMS2.5	280	JX2.5/5	279
CY4Y	110	CYK4BU	126	EPCMT10	280	JX2.5/6	279
CY6	110	CYTLF2.5	124	EPCMT4	280	JX2.5/7	279
CY6BK	110	CYTLF2.5110-240V	124	EPCP1.5	281	JX2.5/8	279
CY6BU	110	CYTLF2.5FT	124	EPCP1.5/3	281	JX4/10	279
CY6GN	110	CYTLF2.5FT(I.S)	124	EPCP1.5/4	281	JX4/16	279
CY6R	110	CYTLF2.5L6-60V	124	EPCP4LG2.5	281	JX4/2	279
CY6Y	110	CYTLGF2.5	124	EPCPDL1.5	281	JX4/3	279
CYDL2.5	117	CYTLGF2.5110-240V	124	EPCPDLK2.5	281	JX4/4	279

Cat. No.	Pg. No.	Cat. No.	Pg. No.	Cat. No.	Pg. No.	Cat. No.	Pg. No.
JX4/5	279	ODLG2.5A	144	SWL4	270		
JX4/6	279	ODLG2.5A(I.S)	144	SWL6	270		
JX4/8	279	PDB120	186	TM3.5	265		
JX6/10	279	PDB185	186	TM5	265		
JX6/2	279	PDB70	185	TX2.5	270		
JX6/3	279	PL-34130010	271	WLX10	270		
JX6/4	279	PL-34130015	271	WLX2.5	270		
JXS10/2.5	279	PL-34130098	271	WLX2.5/V	270		
JXS10/6	279	PL-34902001	271	WLX4	270		
JXS16/2.5	279	PL-34902057	271	WLX6	270		
JXS4/2.5	279	PL-34902081	271				
JXS6/2.5	279	PL-34902106	271				
JXS6/4	279	PL-35003118	271				
JY10/2	279	PL-35003125	271				
JY16/2	279	PL-35003135	271				
JY6/10	279	PL-35003150	271				
JY6/2	279	PL-35003170	271				
JY6/3	279	PL-35003200	271				
JY6/4	279	PP2.5/4UN	281				
JY6/5	279	PP25UN	281				
JY6/6	279	PP35UN	281				
JY6/7	279	PP6/10U	281				
JY6/8	279	PPCBB	281				
MC10	269	PPCBB1	281				
MC10/H/1-10	269	PPCMT4	281				
MC10/V/1-10	269	PPCSFL4U	281				
MC12	269	PPCX10	281				
MC12/H/1-10	269	PPCX4	281				
MC12/V/1-10	269	PPCX4/3	281				
MC16	269	PPCX4/4	281				
MC16/H/1-10	269	PPCY2.5/10	281				
MC16/V/1-10	269	PPCYDL2.5/4	281				
MC2	269	PTB120/150	235				
MC2/H/1-10	269	PTB120/150SH	235				
MC2/V/1-10	269	PTB185/240	235				
MC2B4	269	PTB185/240SH	235				
MC2B4/H/1-10	269	PTB300	236				
MC2B4/V/1-10	269	PTB300SH	236				
MC3.5	269	PTB35/50	234				
MC3.5/H/1-10	269	PTB35/50SH	234				
MC3.5/V/1-10	269	PTB70/95	234				
MC5	269	PTB70/95SH	234				
MC5/H/1-10	269	SCA2.5	267				
MC5/V/1-10	269	SP2.5/4UN	281				
MC6	269	SP6/10U	281				
MC6/H/1-10	269	SPCDL4U	281				
MC6/V/1-10	269	SPCDLG2.5	281				
MC8	269	SPCMB4	281				
MC8/H/1-10	269	SPCP8L32	281				
MC8/V/1-10	269	STH3	213				
MH2.5	267	STH4	214				
MH4	267	STH4DT	225				
MS3.5WHT	268	STH4DT/S	225				
MS5WHT	268	STH4DTBK	225				
NEB10	159	STH4DTBU	225				
NES	159	STH4DTFT	226				
NESCC	159	STH4DTFTBU	226				
ODL2.5	143	STH4DTGN	225				
ODL2.5(I.S)	144	STH4DTR	225				
ODL2.5A	143	STH4DTSH	226				
ODL2.5A(I.S)	144	STH4DTTP	225				
ODL4U	146	STH4DTY	225				
ODL4UA	146	STH4TP	214				
ODL4UBU	146	STH6	214				
ODLG2.5	144	STH6M5	214				
ODLG2.5(I.S)	144	SWL16	270				

Note: The product information is carefully compiled and is accurate for most of the application. New findings in materials and process technology necessitate modification of the products. We reserve the right to change / modify the product without intimation. However the changes that take place without notice in no way reduce function or performance of the product.

MKT/8.2/01 FEBRUARY 2023 x 500

Notes

Blank lined area for notes.

CONNECTWELL INDUSTRIES PVT. LTD.

D-7, Phase 2, M.I.D.C., Dombivli - 421 204, India

connect@connectwell.com

+91 251 7120 600 / 6762 600



LinkedIn



connectwell.com

