

# Preface

**Thank you for choosing SINEE's EM730 series inverter.**

**Document No.: 31010213**

**Release time: May 2022**

**Version: 101**

The EM730 inverter is a high-reliable and small-sized universal inverter launched by SINEE. EM730 supports three-phase AC asynchronous motors. EM730 Permanent magnet synchronous Non-standard supports permanent magnet synchronous motors. They support a variety of drive control technologies, such as the vector VF (VVF) control and speed sensorless vector control (SVC); speed output and torque output; and Wi-Fi access and background software debugging.

## **Features of the EM730 series inverter:**

- Support debugging by the mobile phone APP or monitoring of the inverter status;
- Support Wi-Fi module or serial port access;
- Rich and convenient PC background software functions;
- No need for derating at the ambient temperature of 50 °C;
- Support “one-key shuttle” for fast and accurate speed adjustment;
- Perfect protections: Protections against the short circuit, overcurrent, overvoltage, overload, overheating, etc.

**Before using the EM730 series inverter, please read this manual carefully and keep it properly.**

**While connecting the inverter to motor for the first time, please select the motor type (asynchronous or synchronous) correctly and set the motor nameplate parameters: rated power, rated voltage, rated current, rated frequency, rated speed, motor connection, rated power factor, etc.**

Since we are committed to continuously improving our products and product data, the data provided by us may be modified without prior notice.

For the latest changes and contents, please visit [www.sinee.cn](http://www.sinee.cn).

## Safety precautions

**Safety definition:** Safety precautions are divided into the following two categories in this manual:



**Danger:** The dangers caused by nonconforming operations may include serious injuries and even deaths.



**Warning:** The danger caused by nonconforming operations, including moderate or minor injuries and equipment damage.

During the installation, commissioning and maintenance, please read this chapter carefully, and follow the safety precautions herein. Our company will not be liable for any injury or loss arising from nonconforming operations.

### Precautions

#### Before installation:



**Danger**

1. Do not install the product in the case of water in the package or missing or damaged components found in unpacking!
2. Do not install the product in the case of inconsistency between the actual product name and identification on the outer package.



**Warning**

1. Handle the controller with care; otherwise, it may be damaged!
2. Never use the inverter damaged or with some parts missing; otherwise, injuries may be caused!
3. Do not touch the components of the control system with your hands; otherwise, there is a danger of static damage!

#### During installation:



**Danger**

1. Please install the inverter on a metal retardant object (e.g. metal) and keep it away

- from combustibles; otherwise, a fire may be caused!
2. Do not loosen the fixing bolts of components, especially those with red marks!

 **Warning**

1. Never make wire connectors or screws fall into the inverter; otherwise, the inverter may be damaged!
2. Install the inverter in a place with little vibration and exposure to direct sunlight.
3. When the inverter is installed a relatively closed cabinet or space, pay attention to the installation gap to ensure the effects of heat dissipation.

**During wiring:**

 **Danger**

1. Follow the instructions in this manual, and appoint professional and electrical engineering personnel to complete wiring; otherwise, unexpected dangers may be caused!
2. The inverter and power supply must be separated by a circuit breaker (recommendation: greater than or equal to and closest to twice the rated current); otherwise, a fire may be caused!
3. Before wiring, make sure that the power supply is in the zero energy status; otherwise, electric shock may be caused!
4. Never connect the input power supply to the output terminals (U, V, W) of the inverter. Pay attention to the marks of wiring terminals, and connect wires correctly! Otherwise, the inverter may be damaged!
5. Make the inverter grounded correctly and reliably according to the standards; otherwise, electric shock and fire may be caused!

 **Warning**

1. Make sure that the lines meet the EMC requirements and local safety standards. For wire diameters, refer to the recommendations. Otherwise, an accident may occur!
2. Never connect the braking resistor directly between the DC bus+ and - terminal. Otherwise, a fire may be caused!
3. Tighten the terminals with a screwdriver of specified torque; otherwise, there is a risk of fire.
4. Never connect the phase-shifting capacitor and LC/RC noise filter to the output circuit.
5. Do not connect the electromagnetic switch and electromagnetic contactor to the output circuit. Otherwise, the overcurrent protection circuit of the inverter will be enabled. In severe cases, the inverter may be subject to internal damage.
6. Do not dismantle the connecting cable inside the inverter; otherwise, internal damage may be caused to the inverter.

**Before power-on:**

 **Danger**

1. Make sure that the voltage level of the input power supply is consistent with the rated voltage of the inverter; and the input terminals (R, S, T) and output terminals (U, V, W) of the power supply are connected correctly. Check whether there is short circuit in the peripheral circuits connected to the inverter and whether all connecting lines are tightened; otherwise, the inverter may be damaged!
2. The withstand voltage test has been performed to all parts of the inverter, so it is not necessary to carry it out again. Otherwise, an accident may be caused!

 **Warning**

1. The inverter must not be powered on until it is properly covered; otherwise, electric shock may be caused!
2. The wiring of all peripheral accessories must be in line with the instructions in this manual. All wires should be connected correctly according to the circuit connections in this manual. Otherwise, an accident may occur!

**After power-on:**

 **Danger**

1. Never touch the inverter and surrounding circuits with wet hands; otherwise, electric shock may occur!
2. If the indicator is not ON and the keyboard has no response after power-on, immediately turn off the power supply. Never touch the inverter terminals (R, S, T) and the terminals on the terminal block with your hands or screwdriver; otherwise, electric shock may be caused. Upon turning off the power supply, contact our customer service personnel.
3. At the beginning of power-on, the inverter automatically performs a safety test to external strong current circuits. Do not touch the inverter terminals (U, V, W) or motor terminals; otherwise, electric shock may be caused!
4. Do not disassemble any parts of the inverter while it is powered on.

 **Warning**

1. When parameter identification is required, please pay attention to the danger of injury during motor rotation; otherwise, an accident may occur!
2. Do not change the parameters set by the inverter manufacturer without permission; otherwise, the inverter may be damaged!

**During operation:**

 **Danger**

1. Do not touch the cooling fan, radiator and discharge resistor to feel the temperature; otherwise, burns may be caused!
2. Non-professional technicians must not test signals when the controller is in operation; otherwise, personal injury or equipment damage may be caused!

 **Warning**

1. Prevent any object from falling into the inverter in operation; otherwise, the inverter may be damaged!
2. Do not start or stop the inverter by turning on or off the contactor; otherwise, the inverter may be damaged!

**During maintenance:**

 **Danger**

1. Never carry out repair and maintenance in the live state; otherwise, electric shock may be caused!
2. Maintenance of the inverter must be carried out 10 min after the main circuit is powered off and the display interface of the keyboard is disabled; otherwise, the residual charge in the capacitor will do harm to the human body!
3. Personnel without professional training are not allowed to repair and maintain the inverter; otherwise, personal injury or inverter damage may be caused!
4. The parameters must be set after the inverter is replaced. Plugs in all interfaces must be operated in the power-off status!
5. The synchronous motor generates electricity while rotating. Inverter maintenance and repair must be performed 10 min after the power supply is turned off and the motor stops running; otherwise, electric shock may be caused!

**Cautions**

**Motor insulation inspection**

When the motor is used for the first time or after long-term storage or subject to regular inspection, its insulation should be checked to prevent the inverter from damage caused by failure of the motor winding insulation. During the insulation inspection, the motor must be disconnected from the inverter. It is recommended to use a 500V megohmmeter. The measured insulation resistance must not be less than 5 MΩ.

### **Thermal protection of motor**

If the motor used does not match the rated capacity of the inverter, especially when the rated power of the inverter is greater than that of the motor, the motor must be protected by adjusting the motor protection parameters of the inverter or installing a thermal relay in front of the motor.

### **Operation above power frequency**

This inverter can provide the output frequency of 0.00Hz to 600.00Hz/0.0Hz to 3000.0Hz. When the motor needs to operate above the rated frequency, please consider the capacity of the mechanical device.

### **About motor heat and noise**

Since the inverter outputs PWM waves, containing some harmonics, the temperature rise, noise and vibration of the motor will be slightly more than those in operation at the power frequency.

### **Presence of voltage-dependent device or capacitor increasing the power factor on output side**

The inverter outputs PWM waves. If there is a capacitor increasing the power factor or voltage-dependent resistor for lightning protection on the output side, the inverter may be subjected to instantaneous overcurrent and even damage. Do not use these devices.

### **Use beyond rated voltage**

The EM730 series open-loop vector inverter should not be used beyond the allowable working voltage range specified in this manual; otherwise, the components inside the inverter are prone to damage. If necessary, use the appropriate step-up or step-down device for voltage transformation.

### **Lightning impulse protection**

The inverter of this series is equipped with a lightning overcurrent protector, which has certain capabilities in self-protection against induced lightning. Where lightning strikes occur frequently, a protective device should be added in front of the inverter.

### **Altitude and derating**

In areas with an altitude of more than 1,000 m, where heat dissipation of the inverter is poor due to thin air, derating is required (derating by 1% per 100 m altitude increase to maximum 3,000 m; for ambient temperature above 50 °C , derating by 1.5% per 1 °C temperature rise to maximum 60°C). Contact us for technical advice.

### **Precautions for scrapping of inverter**

Burning of the electrolytic capacitors of the main circuit and printed circuit board may result in explosion, and burning of plastic parts may generate toxic gases. Please dispose of the controller as a kind of industrial waste.

# Contents

- Preface ..... 1**
- Safety precautions ..... 2**
  - Precautions ..... 2**
  - Cautions ..... 5**
- Chapter 1 Overview ..... 10**
  - 1.1 Model and Specification of EM730 Series Inverter ..... 10
  - 1.2 Detailed Introduction to Running Status of EM730 series Inverter ..... 14
- Chapter 2 Installation ..... 19**
  - 2.1 Product Check ..... 19
  - 2.2 Outline Dimensions and Installation Dimensions ..... 20
  - 2.3 Installation Site Requirements and Management ..... 26
  - 2.4 Installation Direction and Space ..... 27
- Chapter 3 Wiring ..... 28**
  - 3.1 Connection of Peripheral Device ..... 28
  - 3.2 Wiring of Main Circuit Terminal ..... 29
  - 3.3 Wiring of Control Circuit Terminal ..... 42
  - 3.4 Extension Wiring of Keyboard ..... 51
  - 3.5 Connection Test ..... 51
- Chapter 4 KEYBOARD OPERATIONS ..... 52**
  - 4.1 Keyboard Functions ..... 52
  - 4.2 Operation Mode of Keyboard with Digital Tube Display ..... 53
  - 4.3 Protection Monitoring ..... 58
  - 4.4 Operation Monitoring ..... 58
  - 4.5 Run/Stop ..... 59
  - 4.6 Other Warning Prompts ..... 60
- Chapter 5 Trial run ..... 61**

- 5.1 Inverter Commissioning Process ..... 61
- 5.2 Confirmation before Power-on ..... 62
- 5.3 Inverter Status Confirmation after Power-on ..... 62
- 5.4 Precautions for Application Macro Setting ..... 62
- 5.5 Start and Stop Control ..... 63
- 5.6 Common Process Parameters of Inverter ..... 66
- 5.7 Motor Parameter Identification ..... 67
  
- Chapter 6 Function Code Table ..... 69**
- 6.1 Description of Function Code Table ..... 69
- 6.2 Table of Functional Parameters ..... 71
  
- Chapter 7 Function Code Details ..... 148**
- 7.1 Basic Function Parameter Group of F00 Group ..... 148
- 7.2 Motor 1 Parameter Group of F01 Group ..... 166
- 7.3 Function Parameter Group of Input Terminal of F02 Group ..... 171
- 7.4 Function Parameter Group of Output Terminal of F03 Group ..... 186
- 7.5 Start/Stop Control Parameter Group of F04 Group ..... 197
- 7.6 VF Control Parameter Group of F05 Group ..... 205
- 7.7 Vector Control Parameter Group of F06 Group ..... 211
- 7.8 F07 Protection Parameter Group ..... 218
- 7.9 Multi-segment Speed and Simple PLC Parameter Group of F08 Group ..... 227
- 7.10 PID Function Parameter Group of F09 Group ..... 237
- 7.11 Communication Function Parameter Group of F10 Group ..... 251
- 7.12 User-selected Parameter Group of F11 Group ..... 256
- 7.13 Keyboard and Display Function Parameter Group of F12 Group ..... 258
- 7.14 Torque Control Parameter Group of F13 Group ..... 265
- 7.15 Parameter Group of Motor 2 of F14 group ..... 270
- 7.16 Auxiliary Function Parameter Group of F15 Group ..... 273
- 7.17 F16 Customized Function Parameter Group ..... 287
- 7.18 Virtual I/O Function Parameter Group of F17 Group ..... 309
- 7.19 Monitoring Parameter Group of F18 Group ..... 313



- 7.20 F19 Protection Record Parameter Group ..... 317
- 7.21 F27 Winding and Unwinding Application Macro Parameter Group ..... 320
- 7.22 F45 Modbus Free Mapping Parameter Group .....306
  
- Chapter 8 Motor Parameter Self-identification ..... 349**
  - 8.1 Motor Parameter Self-identification ..... 349
  - 8.2 Precautions before Self-identification .....349
  - 8.3 Self-identification Steps ..... 350
  
- Chapter 9 Protection/Warning Solutions ..... 352**
  - 9.1 Protection Content ..... 352
  - 9.2 Protection Analysis ..... 357
  - 9.3 Daily Maintenance of Inverter ..... 361
  - 9.4 Instructions for Inverter Warranty .....363
  
- Chapter 10 Select accessories ..... 364**
  - 10.1 Braking Resistor .....364
  - 10.2 Braking Unit .....365
  - 10.3 Wi-Fi Module .....367
  
- Chapter 11 MODBUS Communication Protocol ..... 368**
  - 11.1 Applicable Scope .....368
  - 11.2 Interface Mode ..... 368
  - 11.3 Protocol Format .....368
  - 11.4 Protocol Description ..... 390
  - 11.5 Examples ..... 393

# Chapter 1 Overview

## 1.1 Model and Specification of EM730 Series Inverter

- Rated voltage of power supply:  
Three-phase AC 340~460V, three-phase/single-phase AC 200V~240V;
- Applicable motor: Three-phase AC asynchronous motor (EM730) and permanent magnet synchronous motor (Permanent magnet Non-standard).

The model and rated output current of EM730 series inverter are as shown in Table 1-1.

Table 1-1 EM730 Series Inverter

Rated voltage of power supply	Model	Applicable motor power (kW)	Heavy-duty rated output current (A)	Light-duty rated output current (A)
Single-phase/three-phase AC 200V~240V	EM730-0R4-2B	0.4	2.8	3.2
	EM730-0R7-2B	0.75	4.8	5.0
	EM730-1R5-2B	1.5	8	8.5
	EM730-2R2-2B	2.2	10	11.5
Three-phase AC 340~460V	EM730-0R7-3B	0.75	2.5	3
	EM730-1R5-3B	1.5	4.2	4.6
	EM730-2R2-3B	2.2	5.6	6.5
	EM730-4R0-3B	4.0	9.4	10.5
	EM730-5R5-3B	5.5	13	15.7
	EM730-7R5-3B	7.5	17	20.5
	EM730-011-3B	11	25	28
	EM730-015-3B	15	32	36
	EM730-018-3B	18.5	38	41.5
	EM730-022-3B	22	45	49
	EM730-030-3/3B	30	60	70
	EM730-037-3/3B	37	75	85
	EM730-045-3	45	90	105
	EM730-055-3	55	110	134
	EM730-075-3	75	150	168
	EM730-090-3	90	176	200
	EM730-110-3	110	210	235
	EM730-132-3	132	253	290
EM730-160-3	160	304	340	
EM730-185-3	185	340	—	

	EM730-200-3	200	380	---
	EM730-220-3	220	426	---
	EM730-250-3	250	465	---
	EM730-280-3	280	520	---
	EM730-315-3	315	585	---
	EM730-355-3	355	650	---
	EM730-400-3	400	725	---
	EM730-450-3	450	820	---

- ★ Correct selection of the inverter: The rated output current of the inverter is greater than or equal to the rated current of the motor, taking into account the overload capacity.
- ★ The difference between the rated power of the inverter and that of the motor is usually recommended not to exceed two power segments.
- ★ When a high-power inverter is provided with a low-power motor, the motor parameters must be entered accurately to prevent the motor from damage as a result of overload.

The technical specifications of the EM730 series inverter are shown in Table 1-2.

Table 1-2 Technical Specifications of EM730 Series Inverter

Item		Specification
Power supply	Rated voltage of power supply	Three-phase 340V-10% to 460V+10%, Single-phase/three-phase 200V-10% to 240V+10%; 50-60Hz ± 5%; voltage unbalance rate: <3%
Output	Maximum output voltage	The maximum output voltage is the same as the input power voltage.
	Rated output current	Continuous output of 100% rated current
	Maximum overload current	150% heavy-duty rated current: 60s ( 185~450kw 140% heavy-duty rated current: 60s ); 120% light-duty rated current: 60s; <b>150% light-duty rated current: 10s; 180% light-duty rated current: 2s</b>
Basic control functions	Drive mode	V/F control (VVF); speed sensorless vector control (SVC)
	Input mode	Frequency (speed) input, torque input
	Start and stop control mode	Keyboard, control terminal (two-line control and three-line control), communication

	Frequency control range	0.00~600.00Hz/0.0~3000.0HZ
	Input frequency resolution	Digital input: 0.01Hz/0.1Hz Analog input: 0.1% of maximum frequency
	Speed control range	1:50 (VVF), 1:200 (SVC)
	Speed control accuracy	Rated synchronous speed $\pm 0.2\%$
	Acceleration and deceleration time	0.01 s to 600.00 s / 0.1 s to 6,000.0 s / 1 s to 60,000 s
	Voltage/frequency characteristics	Rated output voltage : 20%~100% adjustable Base frequency : 1Hz~600Hz/3000Hz adjustable
	Torque boost	Fixed torque boost curve Any V/F curve is acceptable.
	Starting torque	150%/1Hz (VVF) 150%/0.25Hz (SVC)
	Torque control accuracy	$\pm 5\%$ rated torque (SVC)
	Self-adjustment of output voltage	When the input voltage changes, the output voltage will basically remain unchanged.
	Automatic current limit	Output current is automatically limited to avoid frequent overcurrent protection actions.
	DC braking	Braking frequency: 0.01 to maximum frequency Braking time: 0~30s Braking current: 0% to 150% rated current
	Signal input source	Communication, multi-speed, analog, etc.
Input and output function	Reference power supply	10V/20mA
	Terminal control power	24V/100mA
	Digital input terminal	5-channel digital multi-function input: X1~X5

		X5 can be used as the high-speed pulse input (max 100kHz).
	Analog input terminal	2-channel analog inputs: One (AI1) voltage source: -10 to 10V input; One channel (AI2): 0 to 10V input voltage or 0 to 20mA input current optional;
	Digital output terminal	Multi-function output of one open collector and one relay Maximum output current of the collector: 50mA; Relay contact capacity: 250VAC/3A or 30VDC/1A, EA-EC: normally open; EB-EC: normally closed
	Analog output terminal	One multi-function analog terminal output M1: 0-10V/0-20mA multi-function analog output terminal
Keyboard	LED display	The LED digital tube displays relevant information about the inverter.
Protection	Protective Function	Short circuit, overcurrent, overvoltage, undervoltage, phase loss, overload, overheat, load loss, external protection, etc.
Use conditions	Location	Indoor, at an altitude of less than 1 km, free of dust, corrosive gases and direct sunlight. When the altitude is higher than 1km, it is derated by 1% per 100m. The maximum allowable altitude is 3km.
	Applicable environment	-10°C to +50°C, 5% to 95%RH (no condensation). When the ambient temperature exceeds 50°C, it needs to be derated by 1.5% per 1°C temperature rise. The maximum allowable ambient temperature is 60°C.
	Vibration	Less than 0.5g
	Storage environment	-40°C ~ +70°C
	Installation method	Wall-mounted or installed in the cabinet
Levels of protection		IP20/IP21 (with plastic baffle)
Cooling method		Forced air cooling

## 1.2 Detailed Introduction to Running Status of EM730 series Inverter

### 1.2.1 Working status of inverter

The working status of EM730 series inverter is divided into: parameter setting status, normal running status, jog running status, self-identification running status, stop status, jog stop status and protection status.

- Parameter setting status: After being powered on and initialized, the inverter will be in the standby status with no trip protection or start command, and have no output.
- Normal running status: Upon receiving a valid start command (from the keyboard, control terminal and communication), the inverter will have the output based on the set input requirements, driving the motor to rotate.
- Jog running status: This is enabled by the keyboard, external terminal or communication, driving the motor to rotate at the jog input speed.
- Self-identification running status: This is enabled by the keyboard, detecting relevant parameters of the motor in the stationary or rotating status.
- Stop status: It is a process for the output frequency to decrease to zero according to the set deceleration time in the case of invalid operating commands.
- Jog stop status: It is a process for the output frequency to decrease to zero according to the jog deceleration time in the case of invalid jog operating commands.
- Protection status: Refer to the inverter status in the case of any protection.

### 1.2.2 Running mode of inverter

The running mode of the inverter refers to the control law of the inverter to drive the motor to rotate at the required speed and torque. The running mode includes:

- General open-loop space vector control-VVF control: suitable for applications where the speed is not changing fast and there are not high requirements for the accuracy of rotating speed, and most AC motor drives.
- Speed sensorless vector control-SVC control: advanced speed estimation algorithm, involving open-loop vector control and high control accuracy but no encoder.

### 1.2.3 Set mode of inverter

The set mode of the inverter refers to the physical quantity that is taken as the controlled target when the inverter drives a motor.

- Speed setting mode with the motor speed as controlled target

Digital setting, analog input setting, high-speed pulse input setting, communication setting, digital potentiometer setting, process PID setting, simple PLC setting or multi-segment speed

setting can be performed separately or in a mixed manner. Fig. 1-1 to Fig. 1-4 detail various input modes of the EM730 series inverter by speed setting.

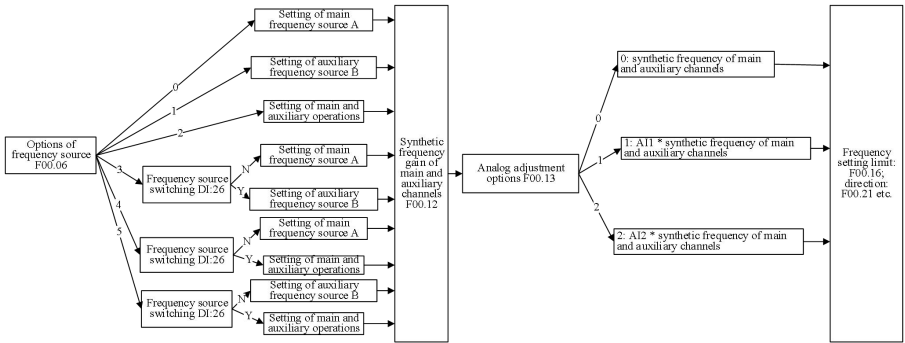

Fig. 1-1 Schematic Diagram of Speed Input Mode

As shown in Fig. 1-1, speed setting of EM730 series inverter is mainly divided into the setting of main frequency source A setting (referred to as “main A”), setting of auxiliary frequency source B (referred to as “auxiliary B”), and setting of main and auxiliary operations. The final settings are made by simply adjustment and limitation (e.g. upper frequency limit, maximum frequency limit, direction limit, frequency hopping limit). See Figs. 1-2 to 1-4 for setting details.

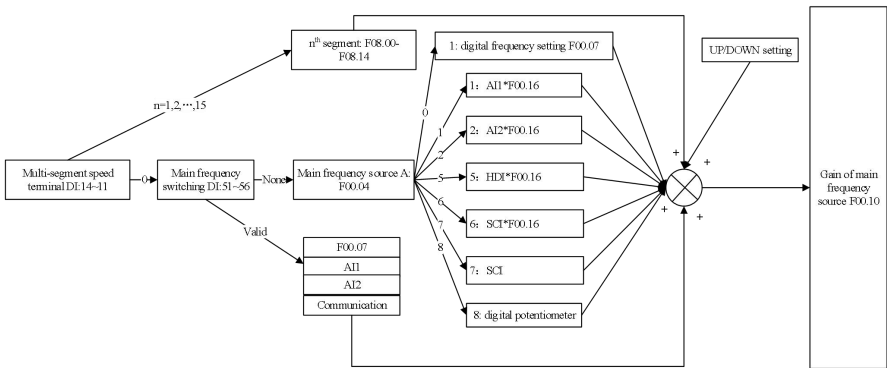

Fig. 1-2 Schematic diagram of Setting of Main Frequency Source A

As shown in Fig. 1-2, it is necessary to comprehensively consider the digital terminal setting and its status during the setting of the main frequency source A. Depending on the terminal settings, multi-segment speed operation can be performed or digital, analog, pulse or

communication settings can be applied directly.

If the terminals are unavailable, the current setting channel is determined by the function code F00.04, and final settings are obtained through UP/DOWN setting calculation.

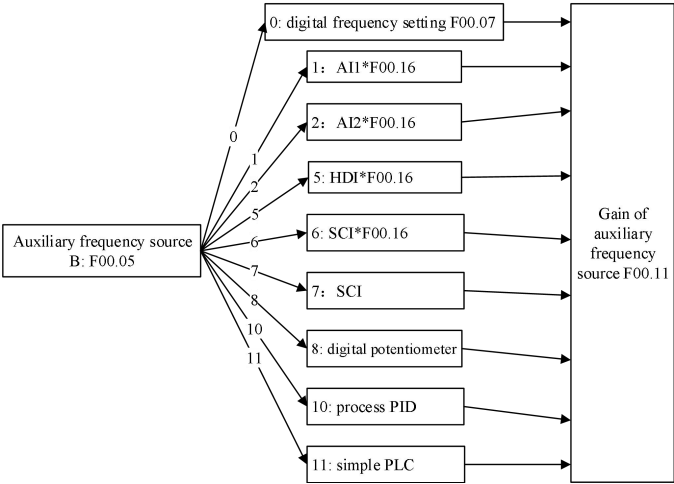

Fig. 1-3 Schematic Diagram of Setting of Auxiliary Frequency Source B

As shown in Fig. 1-3, the current setting channel is determined directly by the function code F00.05 during the setting of the auxiliary frequency source B, and the process PID and simple PLC can be involved in the setting.

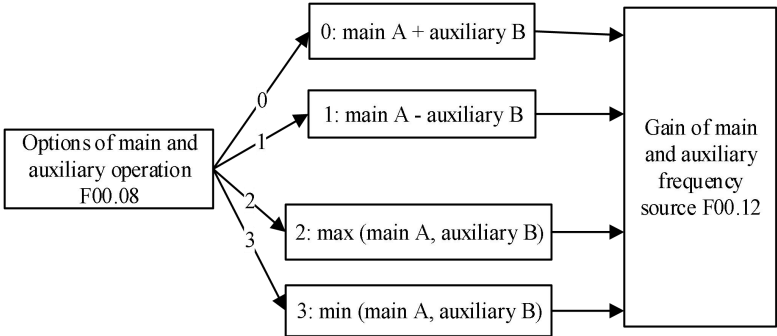

Fig. 1-4 Schematic Diagram of Setting of Main and Auxiliary Operations

As shown in Fig. 1-4, main and auxiliary operations are divided into four types, in which main and auxiliary settings are valid.



- Torque setting mode with the motor current as controlled target

The digital setting, analog input setting, high-speed pulse input setting, communication setting, digital potentiometer setting or multi-segment torque setting can be applied. Fig. 1-5 details the input modes of EM730 series inverters with the set torque.

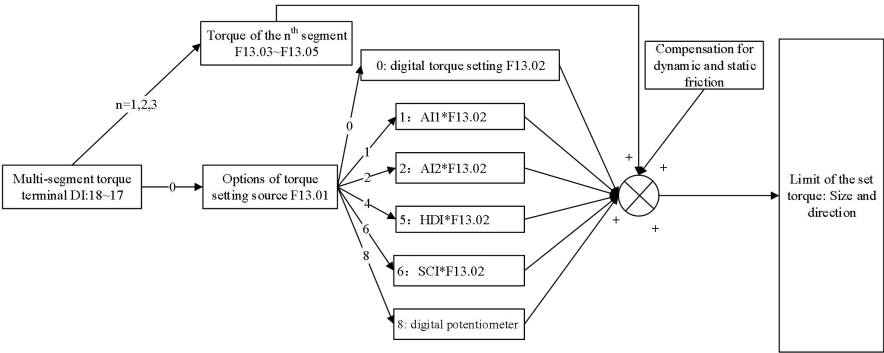

Fig. 1-5 Schematic Diagram of Torque Input Mode

★ : The jog speed setting mode is superior to other setting modes. That is, when the control terminals FJOG and RJOG are enabled, the inverter will automatically change to the jog speed setting mode, regardless of the current setting mode.

### 1.2.4 Operation method of inverter

The operation method of the inverter refers to the operating conditions for the inverter to enable the running status. It includes: keyboard operation, terminal operation and communication operation. Terminal operation is divided into two-line control (RUN, F/R) and three-line control (RUN, F/R, Xi (i=1-5) (change the definition of Xi to three-line operation stop control)). The control logic of this operation method is shown in Fig. 1-6 (take the NPN input

mode as an example).

K1	K2	Running command
0	0	Reverse
0	1	Forward
1	0	Stop
1	1	Stop

0: closed 1: disconncted

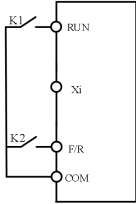

(a) Two-line running mode 0 (F00.03=0)

K1	K2	Running command
0	0	Stop
0	1	Forward
1	0	Reverse
1	1	Stop

0: closed 1: disconncted

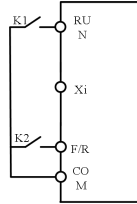

(b) Two-line running mode 1 (F00.03=1)

RUN	Forward button
F/R	Reverse button
Xi	Stop button

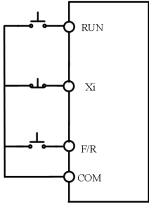

(c) Three-line running mode 0 (F00.03=2)

RUN	Run button
Xi	Stop button
F/R	
1	Forward
0	Reverse

0: closed 1: disconncted

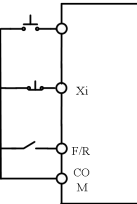

(d) Three-line running mode 1 (F00.03=3)

Fig. 1- 6 Control Logic Diagram of Terminal Operation

## Chapter 2 Installation

### 2.1 Product check

Danger

- **Never install the inverter damaged or with some parts missing.**  
Otherwise, injuries may be caused.

When you get the product, please check it according to Table 2-1.

Table2-1 Check Items

Item to be confirmed	Confirming methods
Check whether the product is consistent with the order.	Check the nameplate on the side face of the inverter.
Check whether any part is damaged.	Check the overall appearance for damage caused in transportation.
Check whether the fastened parts (e.g. screws) are loose.	If necessary, check the product with a screwdriver.

In the case of any defect, contact the agent or our Marketing Department.

- **Nameplate**

**MODEL: EM730-4R0-3B**

**INPUT:**  
U1: 3PH 340-460V 50/60Hz I1: 11.2A

**OUTPUT:**  
U2: 3PH 0-U1 0-600Hz  
I2: 9.4A 4KW



01182309112006163001 100

**SINEE** SHENZHEN SINE ELECTRIC CO., LTD  
**MADE IN CHINA**

● Description of inverter model

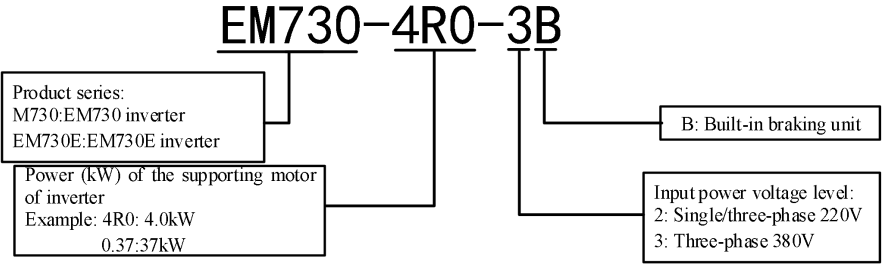

**2.2 Outline dimensions and installation dimensions**

EM730 series inverters involve 25 specifications, 2 types of appearance and 10 installation sizes, as shown in Fig. 2-1 and Table 2-2.

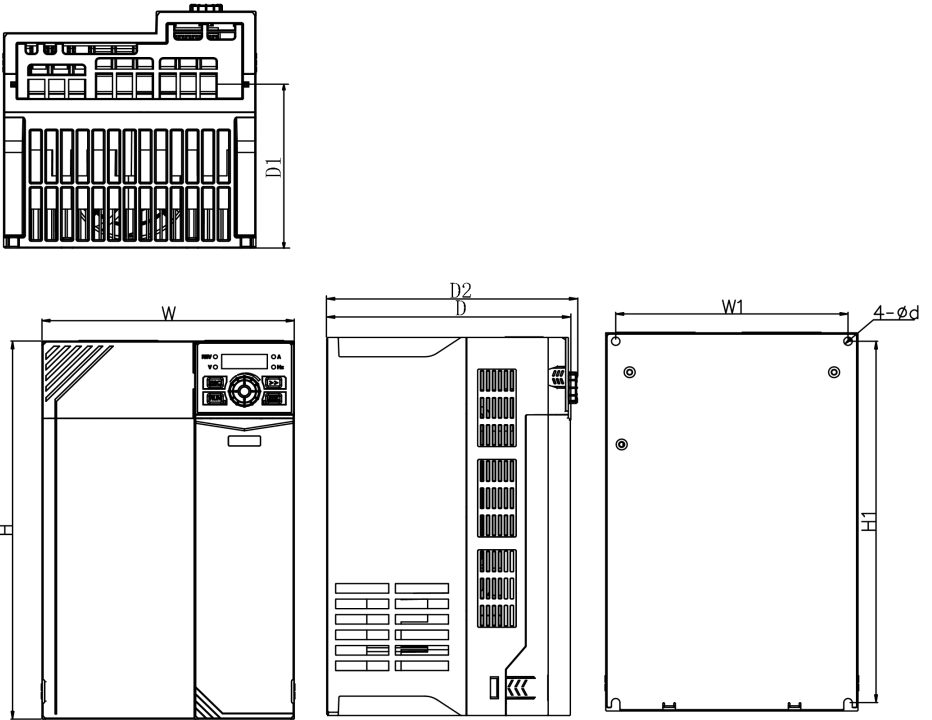

(a) Appearance of EM730-0R7-3B to EM730-022-3B inverters

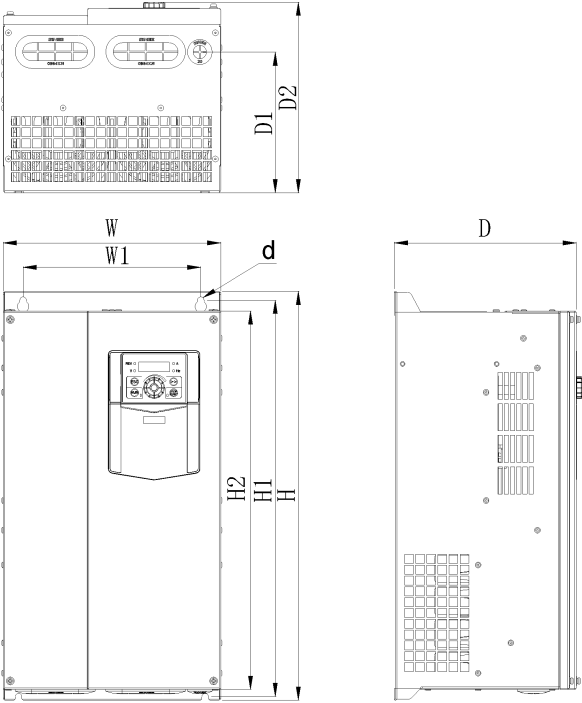

(b) Appearance of EM730-030-3B to EM730-075-3 inverters

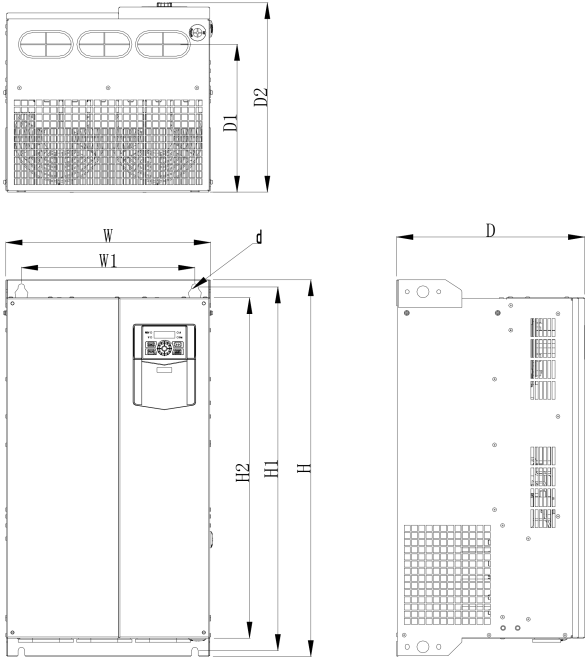

(c) Appearance of EM730-090-3 to EM730-160-3 inverters

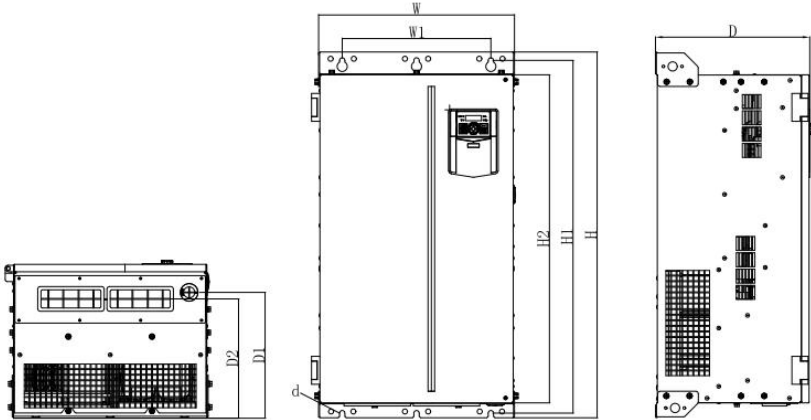

(d) Appearance of EM730-185-3 to EM730-220-3 inverters

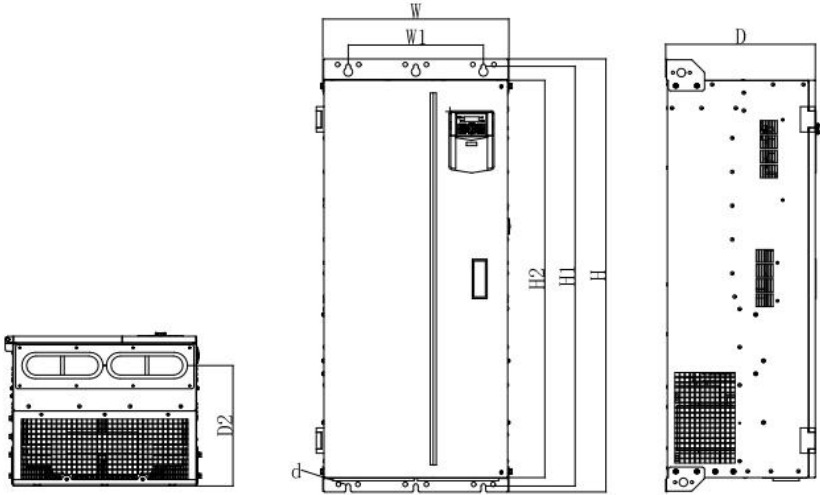

(e) Appearance of EM730-250-3 inverters

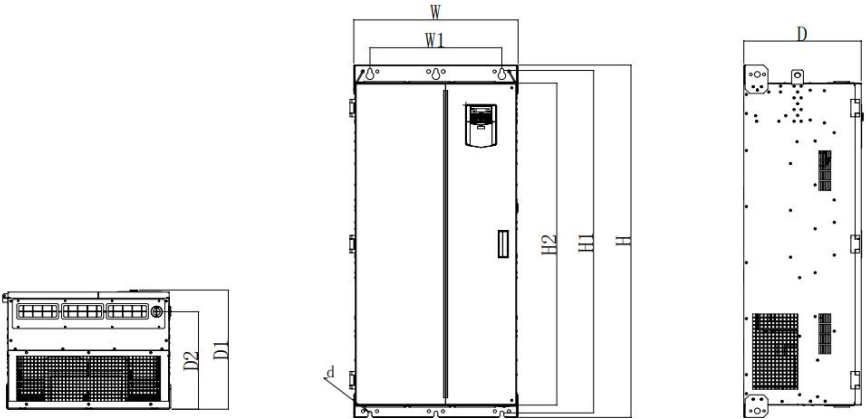

(f) Appearance of EM730-280-3 to EM730-315-3 inverters

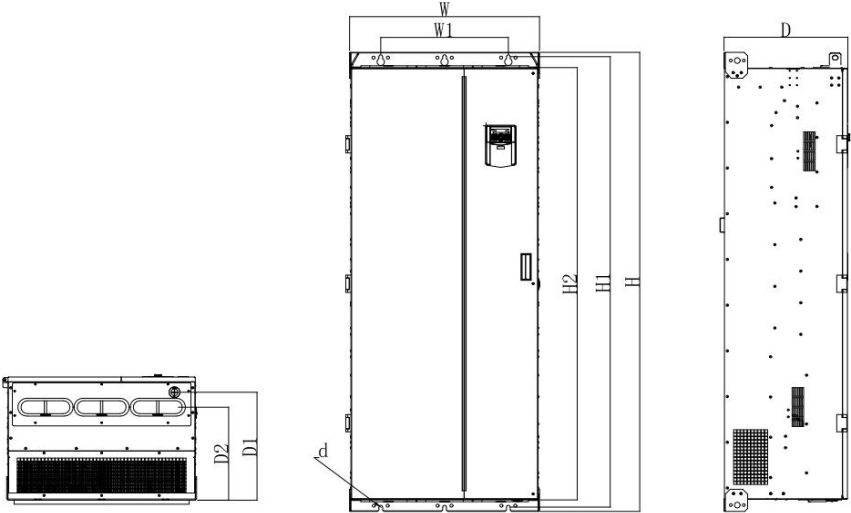

(g) Appearance of EM730-355-3 to EM730-450-3 inverters

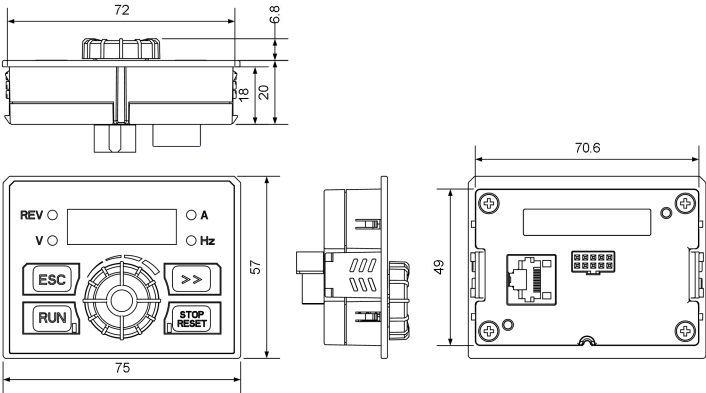

(h) EM730 keyboard appearance

Fig.2-1 Outline Dimensions of EM730 Series Inverter and Keyboard  
 Table 2-2 Outline and Installation Dimensions of EM730 Series Inverter



User Manual of EM730 Series Inverter

Specifications	W	W1	H	H1	H2	D	D1	D2	d
EM730-0R4-2B	75	65	142	132		146	67	152	4.5
EM730-0R7-2B									
EM730-1R5-2B	93	82	172	163		136	85	141	4.7
EM730-2R2-2B									
EM730-0R7-3B	75	65	142	132		146	67	152	4.5
EM730-1R5-3B									
EM730-2R2-3B	93	82	172	163		136	85	141	4.7
EM730-4R0-3B									
EM730-5R5-3B	109	98	207	196		154	103	160	5.5
EM730-7R5-3B									
EM730-011-3B	136	125	250	240		169	115	174	5.5
EM730-015-3B									
EM730-018-3B	190	175	293	280		184	145	189	6.5
EM730-022-3B									
EM730-030-3	245	200	454	440	420	205	156	212	7.5
EM730-030-3B									
EM730-037-3									
EM730-037-3B									
EM730-045-3	300	266	524	508	480	229	174	236	9
EM730-055-3									
EM730-075-3	335	286	580	563	536	228	177	235	9
EM730-090-3	335	286	630	608	570	310	247	317	11
EM730-110-3									
EM730-132-3	430	330	770	747	710	311	248	319	13
EM730-160-3									
EM730-185-3	422	320	786	758	709	335	271	256.4	11.5
EM730-200-3	441	320	1025	989	942	357		285	11.5
EM730-220-3									

EM730-250-3									
EM730-280-3	560	450	1024	1170.5	1100	400		333	13
EM730-315-3									
EM730-355-3	660	443	1597	1567	1504	430	375.5	325.5	13
EM730-400-3									
EM730-450-3									

### 2.3 Installation Site Requirements and Management

 <b>Attention</b>
<ol style="list-style-type: none"> <li>1、 <b>When carrying the inverter, hold its bottom.</b> If you hold the panel only, the body main fall to hit your feet.</li> <li>2、 <b>Install the inverter on non-flammable boards (e.g. metal).</b> If the inverter is installed on a flammable object, a fire may occur.</li> <li>3、 <b>When two or more inverters are installed in one control cabinet, please install a cooling fan and keep the air temperature below 50 °C at the air inlet.</b> Overheating may cause fire and other accidents.</li> </ol>

#### 2.3.1 Installation site

The installation site should meet the following conditions:

1. The room is well ventilated.
2. The ambient temperature should be  $-10^{\circ}\text{C}$  to  $50^{\circ}\text{C}$ . When the plastic case is used at the ambient temperature above  $40^{\circ}\text{C}$ , remove the top baffle.
3. The controller should be free from high temperature and humidity (less than 90% RH) or rainwater and other liquid droplets.
4. Please install the inverter on a fire-retardant object (e.g. metal). Never install it on flammable objects (e.g. wood).
5. No direct sunlight.
6. There should be no flammable or corrosive gas and liquid.
7. There should be no dust, oily dust, floating fibers or metal particles.
8. The installation foundation should be secured and vibration-free.
9. Avoid electromagnetic interference and keep the controller away from interference sources.

10. The installation site must have a good and reliable grounding environment.

### 2.3.2 Environment temperature

In order to improve the operational reliability, please install the inverter in a well-ventilated place. When it is used in a closed cabinet, a cooling fan or cooling air conditioner should be installed to keep the ambient temperature below 50°C.

### 2.3.3 Preventive measures

Take protective measures to the inverter during installation to prevent metal fragments or dust generated in drilling and other processes from falling into the inverter. Remove the protection after installation.

## 2.4 Installation Direction and Space

The EM730-1R5-3B inverters and above are equipped with the cooling fan for forced air cooling. To ensure good cyclic cooling effects, the inverter must be installed in a vertical direction, and sufficient spaces must be reserved between the inverter and adjacent objects or baffles (walls). Refer to Fig. 2-2.

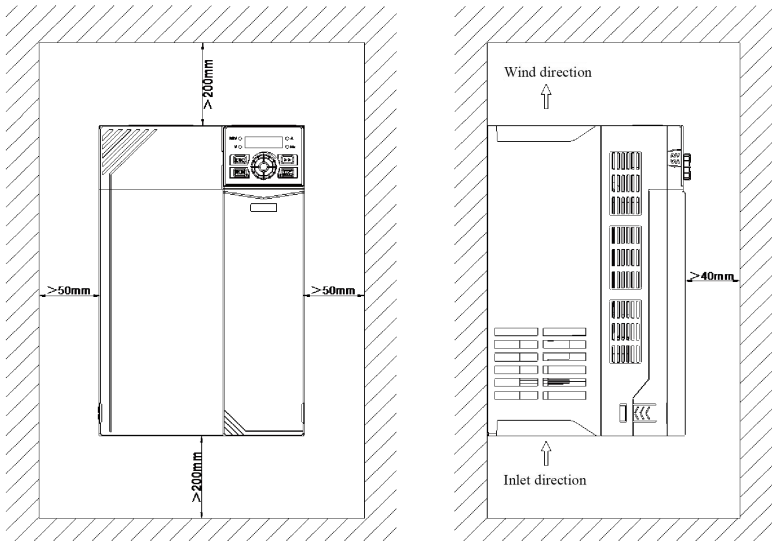

Fig.2- 2 Inverter Installation Direction and Space

# Chapter 3 Wiring

## 3.1 Connection of Peripheral Device

The standard connection between the EM730 series inverter and peripheral devices is shown in Fig.3- 1.

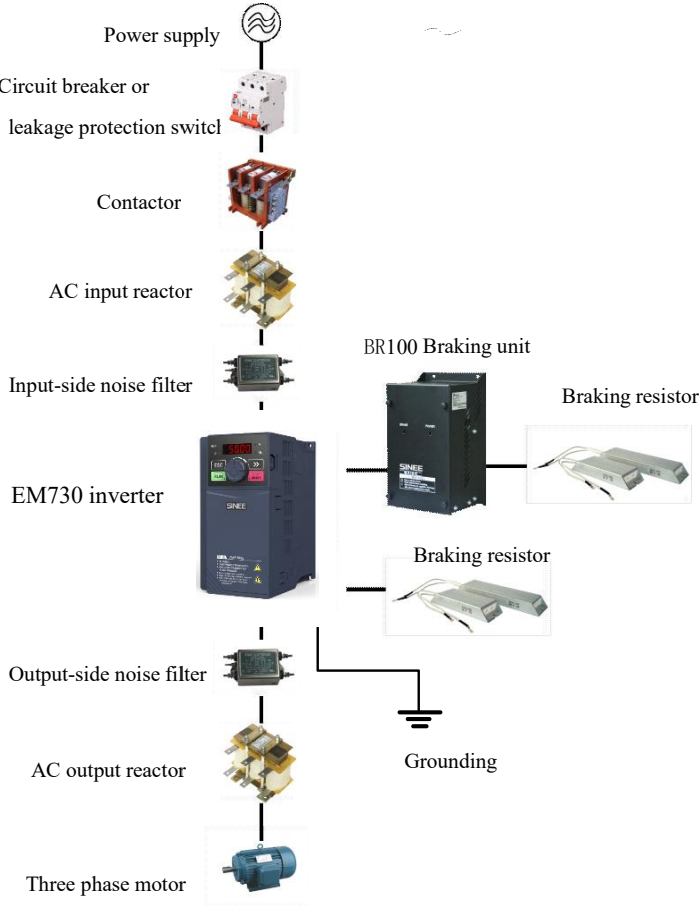

Fig.3- 1 Connection of Inverter and Peripheral Devices

### 3.2 Wiring of Main Circuit Terminal

#### 3.2.1 Composition of main circuit terminal

The main circuit terminal of the EM730 series inverter consists of the following parts:

- Three-phase AC power input terminals: R, S, T
- Earth terminal:  $\perp$
- DC bus terminals:  $\oplus, \ominus$
- Terminals of dynamic braking resistor: PB,  $\oplus$
- Motor terminals: U, V, W

The layout of main circuit terminals is shown in Fig. 3-2.

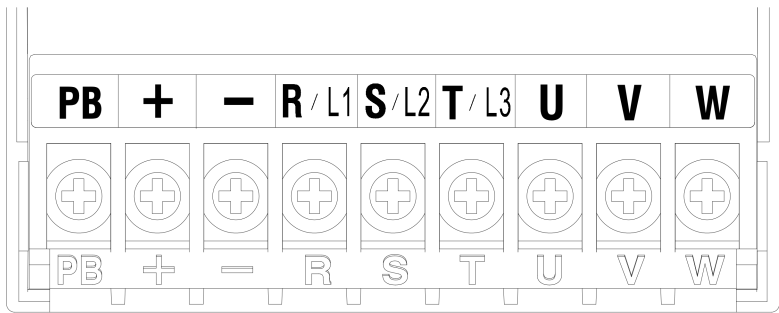

a) Schematic Diagram of Terminals (EM730-0R7-3B~EM730-1R5-3B)

Note:

EM730-0R4-2B~ EM730-0R7-2B terminals are the same as EM730-0R7-3B~ EM730-1R5-3B;

EM730-1R5-2B~ EM730-2R2-2B terminals are the same as EM730-2R2-3B~ EM730-4R0-3B.

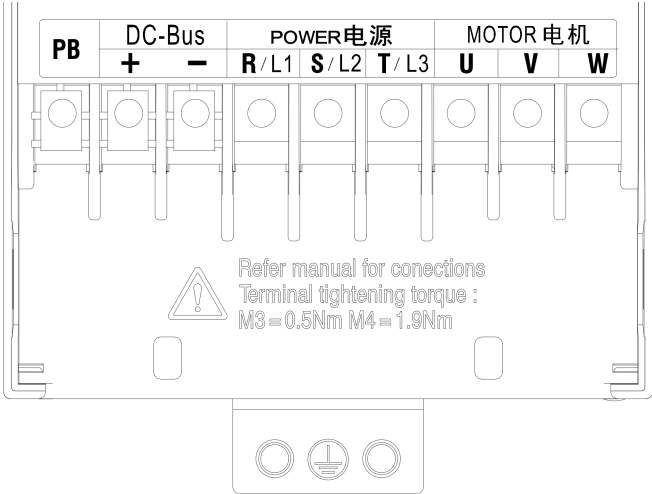

b) Schematic Diagram of Terminals (EM730-2R2-3B~EM730-4R0-3B)

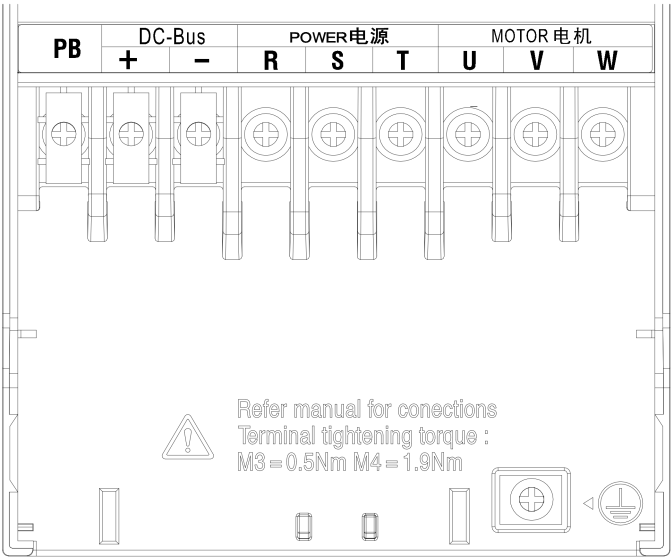

c) Schematic Diagram of Terminals (EM730-5R5-3B~EM730-022-3B)  
(with slight difference in the grounding position)



d) Schematic Diagram of Terminals (EM730-030-3/3B~EM730-037-3/3B)

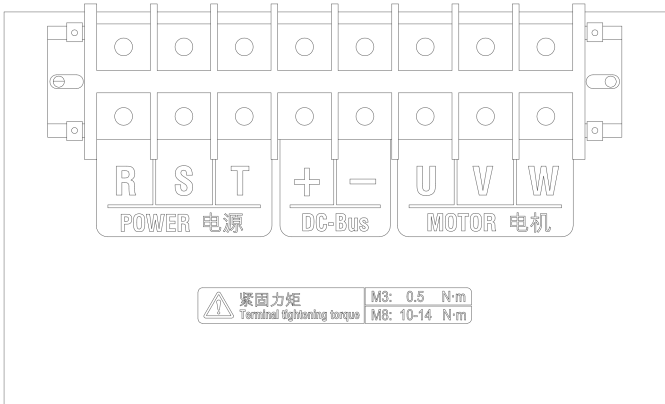

e) Schematic Diagram of Terminals (EM730-045-3~EM730-110-3)

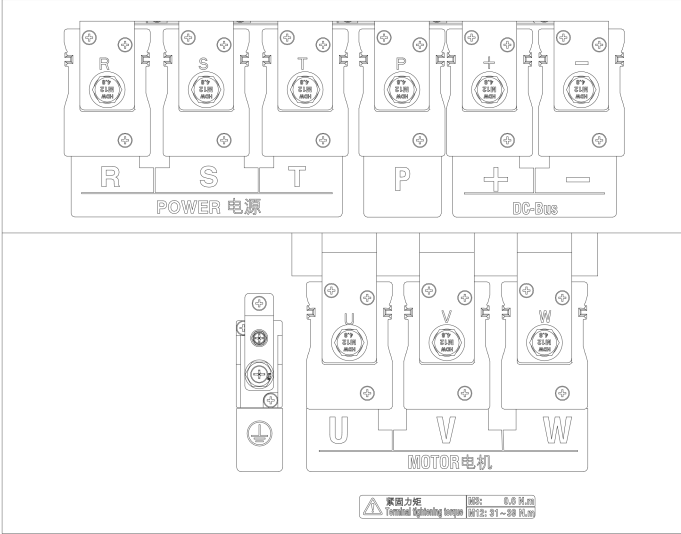

f) Schematic Diagram of Terminals (EM730-132-3~EM730-160-3)

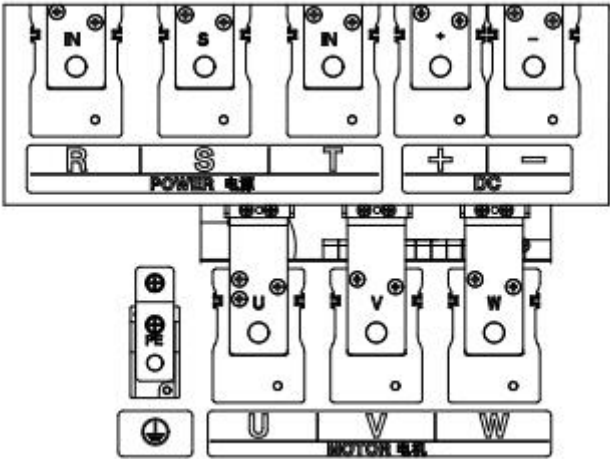

(g) Schematic Diagram of Terminals (EM730-185-3~EM730-250-3)



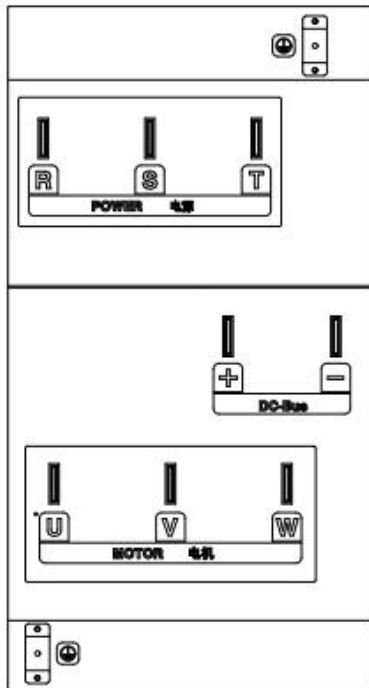

(h) Schematic Diagram of Terminals (EM730-280-3~EM730-450-3)

### 3.2.2 Functions of main circuit terminals

The functions of the main circuit terminals of the EM730 series inverter are shown in the following table. Please connect wires correctly according to the corresponding functions.

Functions of main circuit terminals

Terminal label	Function description
R/L1, S/L2, T/L3	AC power input terminal, connected to three-phase AC power supply (the single-phase power input terminal can be connected with any two terminals)
U, V, W	AC output terminal of the inverter, connected to three-phase AC motor
⊕ ⊖	Positive and negative terminals of the internal DC bus, connected to external braking unit
⊕, PB	Braking resistor terminal, with one end of the braking resistor connected to ⊕ and the other end to PB

P, ⊕	DC reactor terminal, for the external DC reactor of EM730-090-3 and above
⊖	Grounding terminal, connected to earth

### 3.2.3 Standard wiring diagram of main circuit

The standard wiring diagram of the main circuit of the EM730 series inverter is shown in Fig. 3-3.

● Wiring of built-in brake unit

● Wiring of external brake unit

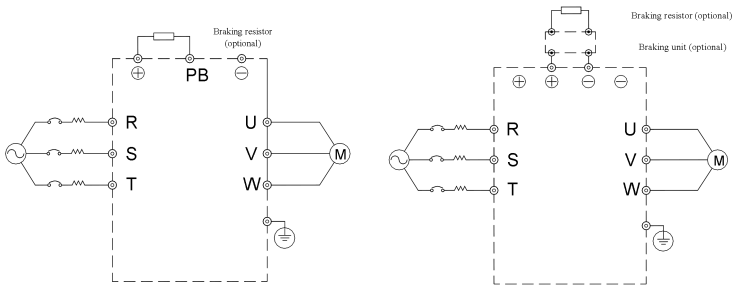

Fig.3-3 Standard Wiring of Main Circuit

### 3.2.4 Input side wiring of main circuit

#### Installation of circuit breaker

Install the air circuit breaker (MCCB) corresponding to the inverter between the power supply and input terminal.

- The MCCB capacity should be 1.5-2 times the rated current of the inverter.
- The time characteristics of the MCCB must meet the requirements for overheat protection (150% rated current/1 minute) of the inverter.
- When the MCCB is used with multiple inverters or other devices, connect the protection output relay contact of the inverter in series to the power contactor coil, as shown in Fig.3-4, to disconnect the power supply according to the protection signal.

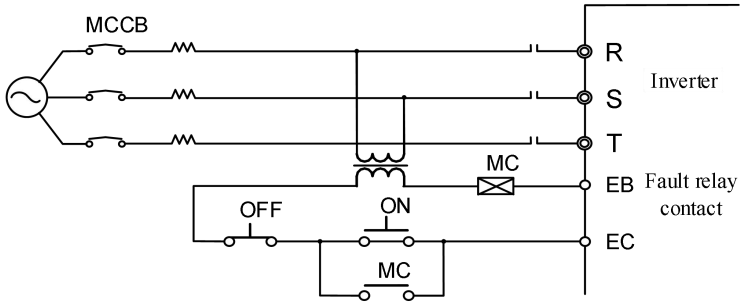

Fig.3-4 Connection of Input Circuit Breaker

### Installation of leakage circuit breaker

Since the inverter outputs high-frequency PWM signals, a high-frequency leakage current will be generated. Please use the dedicated leakage circuit breaker with the current sensitivity above 30 mA. If an ordinary leakage circuit breaker is used, use a leakage circuit breaker with the current sensitivity above 200 mA and action time of more than 0.1 s.

### Installation of electromagnetic contactor

Connect the electromagnetic contactor that matches the power of the inverter, as shown in Fig. 3-4.

- Do not control the operation and stop of the inverter via the electromagnetic contactor on the incoming line side. Frequent use of this method is an important cause of damage to the inverter. The frequency of operation and stop of the electromagnetic contactor on the incoming line side must not exceed once every 30 min.
- After the power supply is restored, the inverter will not run automatically.

### Connection with terminal block

The phase sequence of the input power supply is unrelated to that (R, S, T) of the terminal block, so that the terminals of the input power supply can be connected arbitrarily.

### Installation of AC reactor

When a large-capacity (above 600KVA) power transformer is connected, or the input power supply is connected to a capacitive load, a high inrush current will be generated, which

will cause damage to the rectifier part of the inverter. In this case, please connect a three-phase AC reactor (optional) to the input side of the inverter. This will not only suppress the peak current and voltage, but also improve the power factor of the system.

**Installation of surge suppressor**

When an inductive load (electromagnetic contactor, solenoid valve, solenoid coil, electromagnetic circuit breaker, etc.) is connected near the inverter, please install a surge suppressor.

**Installation of noise filter on power supply side**

The noise filter is used to suppress the noise that invades the inverter from the power cable, and the impact of inverter noise on the power grid.

- Use a dedicated noise filter for the inverter. Ordinary noise filters do not have good effects, so they are not used usually.
- The correct and incorrect installations of the noise filter are shown in Fig. 3-5 and Fig. 3-6.

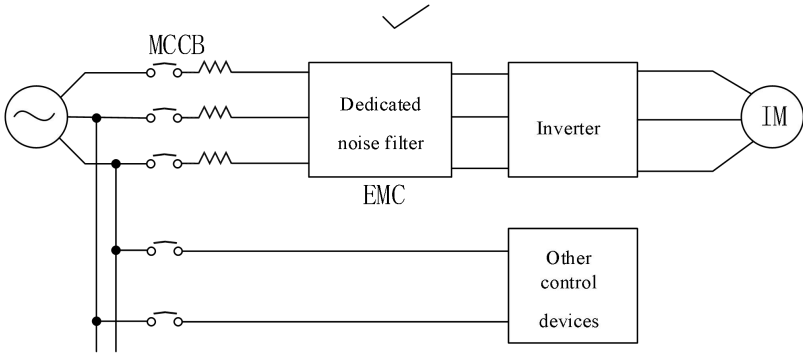

Fig.3- 5 Correct Installation of Noise Filter

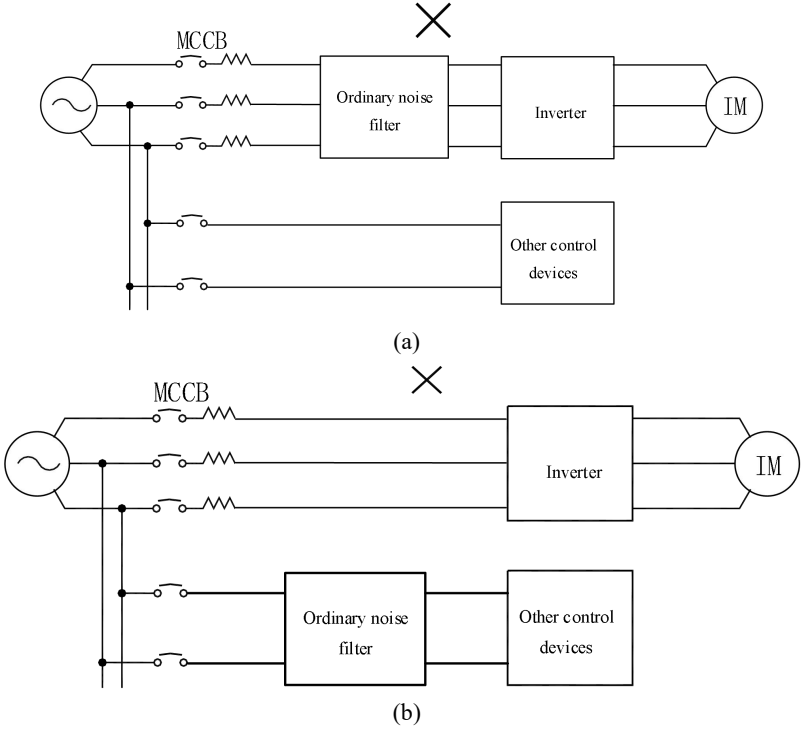

Fig. 3-6 Incorrect Installation of Noise Filter

### 3.2.5 Output side wiring of main circuit

#### Wiring of inverter and motor

Connect the output terminals (U, V, W) of the inverter to those (U, V, W) of the motor.

During operation, check whether the motor rotates forward when a forward rotation command is sent. If the motor rotates reversely, exchange any two wires of the output terminals (U, V, W) of the inverter.

#### Prohibition of connection of the power cable to output terminal

Never connect the power cable to output terminal. When the voltage is applied on the output terminal, the internal components of the inverter may be damaged.

### Prohibition of short circuit or grounding of output terminal

Do not directly touch the output terminals, or short-circuit the output cable and inverter housing; otherwise, electric shock and short circuit may be caused. In addition, never short-circuit the output cable.

### Prohibition of use of phase-shifting capacitor

Do not connect a phase-shifting advanced electrolytic capacitor or LC/RC filter to the output circuit; otherwise, the inverter may be damaged.

### Prohibition of use of electromagnetic switch

Do not connect the electromagnetic switch or electromagnetic contactor to output circuit. Otherwise, such devices will enable overcurrent and overvoltage protection and even damage the internal components of the inverter in severe cases.

When an electromagnetic contactor is used to switch the PF power supply, make sure that switching is not performed until the inverter and motor are shut down.

### Installation of noise filter on output side

Connect a noise filter on the output side of the inverter to reduce inductive interference and radio interference.

- Inductive interference: Electromagnetic induction will lead to noise of the signal line and malfunction of controls.
- Radio interference: The high-frequency electromagnetic waves emitted by the inverter itself and cables will cause interference to nearby radio devices and noise in signal reception.
- The noise filter installation on the output side is shown in Fig. 3-7.

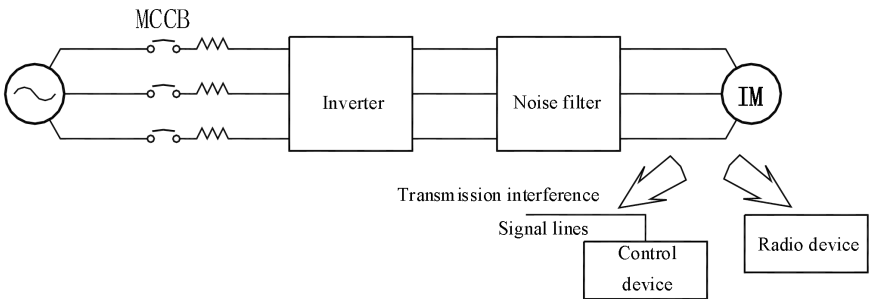

Fig.3-7 Noise Filter Installation on Output Side

### Solution to inductive interference

To suppress the inductive interference on the output side, all output cables can be laid in the grounded metal tubes, in addition to the aforesaid installation of the noise filter. When the distance between the output cable and signal line is greater than 30 cm, the impact of inductive interference will decrease significantly, as shown in Fig. 3-8.

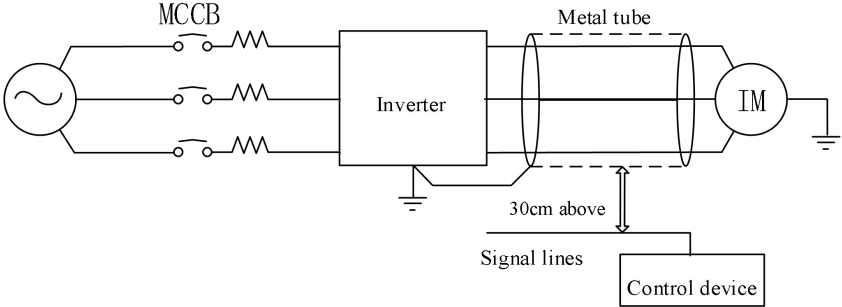

Fig.3-8 Solution to Inductive Interference

### Solution to RF interference

The input cable, output cable and inverter itself generates RF interference, which can be reduced by installing noise filters on the input and output sides and shielding the inverter body with an iron box, as shown in Fig. 3-9.

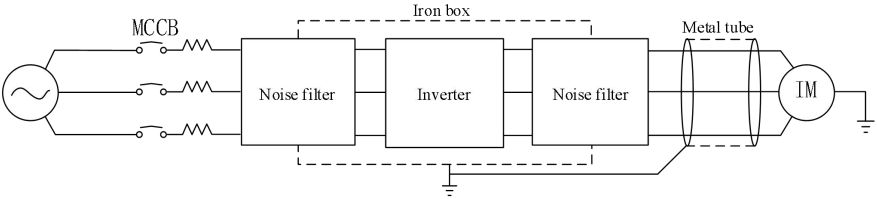

Fig.3-9 Solution to RF Interference

### Wiring distance between inverter and motor

The longer the wiring distance between the inverter and motor, the higher the carrier frequency and the higher harmonic leakage current in the cable. This will adversely affect the inverter and nearby devices. Refer to Table 3-2 to adjust the carrier frequency and reduce the high-frequency leakage current.

- When the motor wiring distance exceeds 50 m, connect the output terminals (U, V, W) of the inverter with the dedicated AC reactor (phase capacity: the same as that of the inverter) for inverter output.

Table3-2 Wiring Distance and Carrier Frequency between Inverter and Motor

Wiring distance between inverter and motor	<50m	<100m	>100m
Carrier frequency	Below 10kHz	Below 8kHz	Below 5kHz
Function code F00.23	10.0	8.0	5.0

### 3.2.6 Cable and screw dimensions of main circuit

The cable and screw dimensions of the main circuit are shown in Table 3-3.

Table3-3 Cable Dimensions and Terminal Screw Specifications

Frequency converter model	Terminal Symbol	Terminal Screw	Tightening Torque (N.m)	Wire diameter (mm <sup>2</sup> )	Wire Type
EM730-0R4-2B	PB, +, -, R, S, T, U, V, W	M3	0.5~0.7	1.5	750V wire
EM730-0R7-2B					
EM730-0R7-3B					
EM730-1R5-3B		M4	1.5~2.0	4	
EM730-1R5-2B					
EM730-2R2-2B					
EM730-2R2-3B					
EM730-4R0-3B					
EM730-5R5-3B					
EM730-7R5-3B		M5	3.0~4.0	10	
EM730-011-3B					
EM730-015-3B					
EM730-018-3B					
EM730-022-3B	R, S, T, PB, +, -, U, V, W,	M6	4.0~5.0	25	
EM730-030-3B					
EM730-037-3B					
EM730-030-3					
EM730-037-3					
EM730-045-3	R, S, T, +, -, U, V, W,			35	



EM730-055-3	R, S, T, P, +, -, U, V, W	M8	9.0~10.0	35	
EM730-075-3		M10	17.0~22.0	60	
EM730-090-3				60	
EM730-110-3				90	
EM730-132-3				90	
EM730-160-3				120	
EM730-185-3	R, S, T, P, +, -, U, V, W	M12	30.0~40.0	180	
EM730-200-3				2*120	
EM730-220-3					2*150
EM730-250-3					
EM730-315-3					
EM730-355-3					
EM730-400-3					
EM730-450-3					

Table 3-1 Cable Dimensions and Terminal Screw Specifications **Note:** 1: The specifications of the wire are dependent on its voltage drop. Under normal circumstances, the voltage drop calculated by the following formula should be less than 5V.

$$\text{Voltage drop} = \sqrt{3} * \text{wire resistivity } (\Omega/\text{KM}) * \text{wire length (m)} * \text{rated current (A)} * 10^{-3}$$

2: If the wire is in a plastic slot, it should be enlarged by one level.

3: The wire should be crimped to the round terminal suitable for the wire and terminal screw.

4: The specification of the ground wire should be the same as that of the power cable smaller than 16mm<sup>2</sup>. When the power cable is 16mm<sup>2</sup> or larger, the ground wire should not be smaller than 1/2 of the power cable.

### 3.2.7 Ground wire

- The ground terminal  must be grounded.
- Pay special attention to the third type of grounding (grounding resistance: less than 10Ω).
- The ground wire must not be shared by the welding machine and power devices.

- Select the ground wire according to the technical specifications for electrical equipment, and minimize the length of the ground wire connected to the grounding point.
- Where two or more inverters are used, the ground wires must not form a loop. The correct and incorrect grounding methods are shown in Table 3-10.

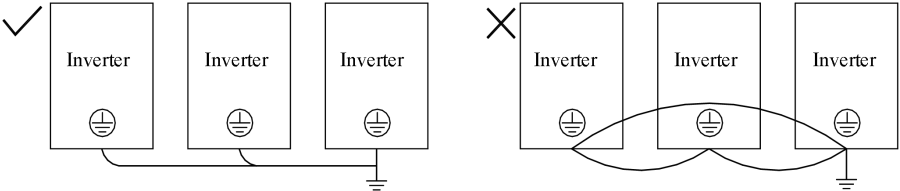

Fig.3- 10 Connection of Ground Wire

**3.2.8 Installation and wiring of braking resistor and braking unit**

Refer to Chapter 10 for the selection and wiring of the braking resistor and braking unit.

For the inverter with a built-in braking unit, connect the braking resistor between the inverter terminal (+) and PB terminal. For the inverter with no built-in braking unit, connect the terminals (+ and -) of the braking unit to those (+ and -) of the DC bus of the inverter, and the braking resistor to the PB+ and PB- terminals of the braking unit. Refer to the user manual of the BR100 braking unit for more information.

**3.3 Wiring of Control Circuit Terminal**

**3.3.1 Composition of control circuit terminal**

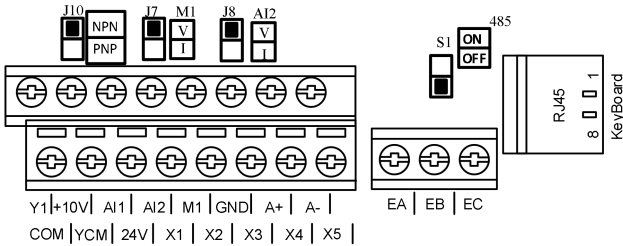

Fig.3- 11 Layout of Control Circuit Terminals 1

## 3.3.2 Functions and wiring of control circuit terminals

Table 3-3 Functions of Control Circuit Terminals

Category	Terminal label	Terminal name	Function description
Power supply	24V	External power supply	Supply 24V power to external devices, with the maximum output current of 100mA.
	COM	Power grounding terminal	Power grounding terminal of the external power supply, and common side of the digital input terminal
Analog input	$\pm 10V$	Analog terminal power supply	Supply 10V power to external devices. Maximum output current: $10.5 \pm 0.5V/20mA$ , usually as the power supply of the external potentiometer
	GND	Analog power grounding terminal	Grounding terminal of analog input and output
	A11	Analog voltage input	-10V to 10V, $50k\Omega$ input impedance, bipolar analog voltage input
	A12	Analog current/voltage input	Current or voltage type Input range: 0/4-20mA or 0-10V
Analog output	M1	Analog voltage/current output	0-10V/0-20mA; output accuracy: $\pm 2\%$
Digital input port	X1	Multi-function input terminal	Program the corresponding terminals by setting function codes, to realize the input control of the set functions. The input terminal supports PNP and NPN input modes, and the default mode is the NPN input mode. X5 can also be used as the high-frequency pulse input, with the input frequency up to
	X2		
	X3		
	X4		
	X5		

			100kHz.
Multi-function digital output	Y1	Open collector output terminal	It can be programmed as the multi-function output terminal.
	YCM	Common side of Y terminal	The common side YCM of Y terminal and the common side COM of the digital input terminal are independent of each other.
Communication	A+	RS485 communication terminal	positive terminal of RS485 differential signal
	A-		negative terminal of RS485 differential signal
Relay output	EA	Relay output terminal	EA-EC: Normally open EB-EC: Normally closed
	EB		
	EC		
External keyboard port	RJ45	External keyboard terminal	For the external operation panel The upper computer can also be connected through this port for background software debugging.

### 3.3.3 Wiring of analog input terminal

#### Wiring of AI1 and AI2 terminals with analog voltage signal:

When the AI2 terminal is in the mode of analog voltage signal input, the switch J8 on the control panel is set to the voltage mode, as shown in Fig. 3-12

When the analog voltage input signal is powered by an external power supply, the wiring of terminals AI1 and AI2 is shown in Fig. 3-12-a.

When the analog voltage input signal is sent by a potentiometer, the terminals AI1 and AI2 are connected as shown in Fig. 3-12-b.

In addition, F02.62 (AI1 input type) and F02.63 (AI2 input type) should be set according to actual needs (0: 0-10V; 1: 4-20mA; 2: 0-20mA; 4: 0-5V).

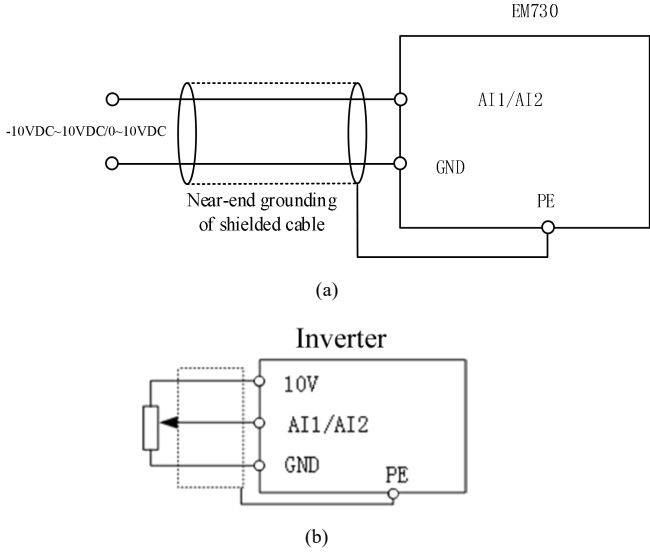

Fig.3- 12 AI1/AI2 Terminal Wiring Diagram

**Wiring of the input analog current signal of AI2 terminal:**

When the AI2 terminal is in the mode of analog current signal input, the switch J8 on the terminal block is set to the current mode.

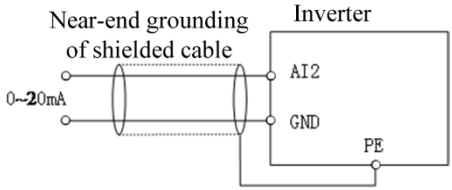
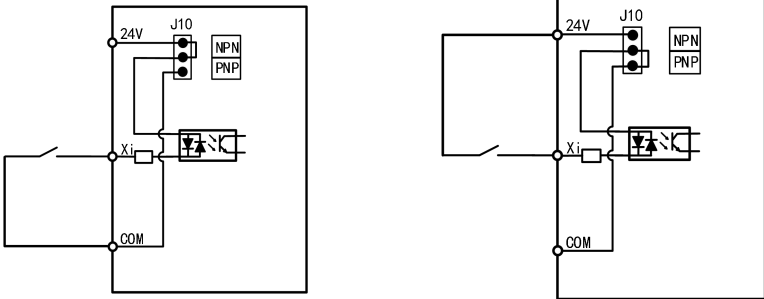

Fig.3- 13 Wiring Diagram of External Current Source and AI2 Terminal

### 3.3.4 Wiring of multi-function input terminal

The multi-function input terminals of EM730 series inverters support the access in the NPN or PNP mode. The terminals X1~X5 can be flexibly connected with external devices. The NPN or PNP mode (NPN by default) can be selected via the jumper cap J10 on the control panel. The wiring of the multi-function input terminal in different modes is shown below:



a: Use of internal power supply in NPN mode

b: Use of internal power supply in PNP mode

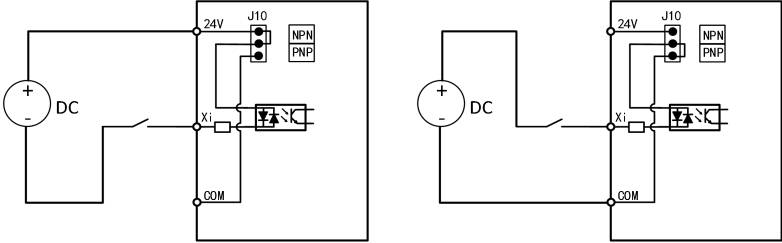

c: Use of external power supply in NPN mode

d: Use of external power supply in PNP mode

Fig. 3-14 Wiring Diagram of Multi-function Input Terminals

### 3.4 Wiring of multi-function output terminals

The multi-function output terminal Y1 is powered on by the internal 24V power supply of the inverter or an external power supply, as shown in Fig. 3-15:

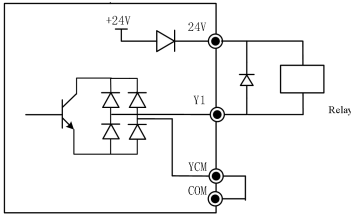

a: Use of internal power supply NPN

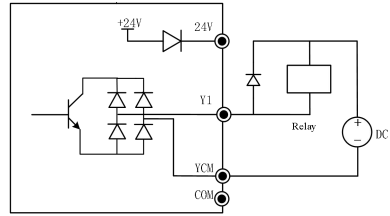

b: Use of external power supply NPN

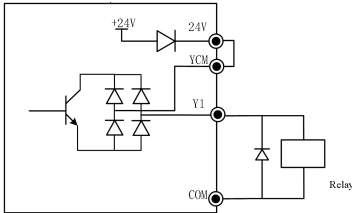

a: Use of internal power supply PNP

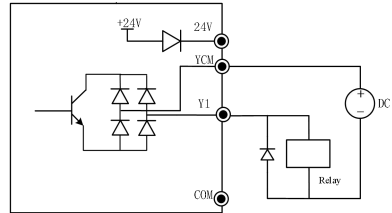

b: Use of external power supply PNP

Fig.3- 15 Wiring of Multi-function Output Terminals

Note: An anti-parallel diode must be included in the relay wire package. The absorption circuit components should be installed at both ends of the coil of the relay or contactor.

### 3.4.1 Wiring of analog output terminals

The external analog meter connected to the analog output terminal M1 indicates a variety of physical quantities. Choose the output current (0~20mA) or (0~10V) via the jumper cap, M1 corresponding to J7. Set F03.34 as needed (0: 0~10V; 1: 4-20mA; 2: 0~20mA). The jumper cap and terminal wiring is as follows:

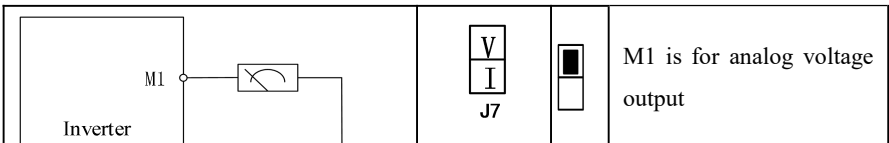

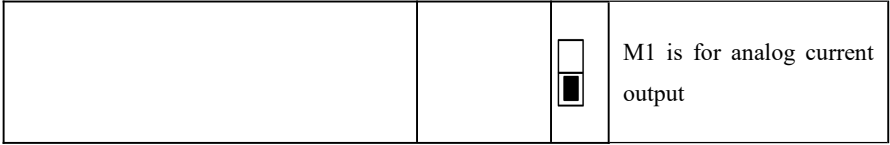

**3.4.2 Wiring of 485 communication terminals**

The communication terminals A+ and A- are the RS485 communication interfaces of the inverter. The online control of the host (PC or PLC controller) and inverter is performed through the connection and communication with the host. The connection of the RS485 and RS485/RS232 adapters to EM730 series inverter is shown in Fig. 3-16, Fig. 3-17 and Fig. 3-18.

- Direct connection of the RS485 terminal of a single inverter to the host for communication:

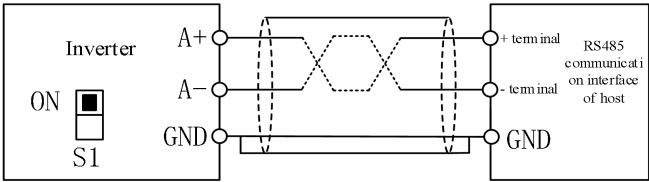

Fig.3- 16 Communication Terminal Wiring of Single Inverter

- Connection of the RS485 terminals of multiple inverters to host for communication:

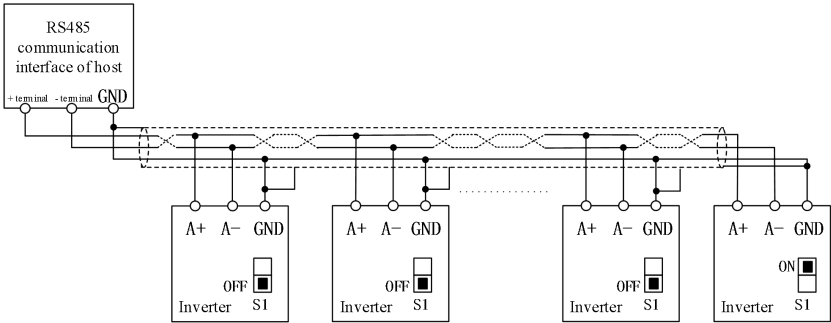

Fig. 3- 17 Wiring of Communication Terminals of Multiple Inverters

- Connection to the host via RS485/RS232 adapter for communication:



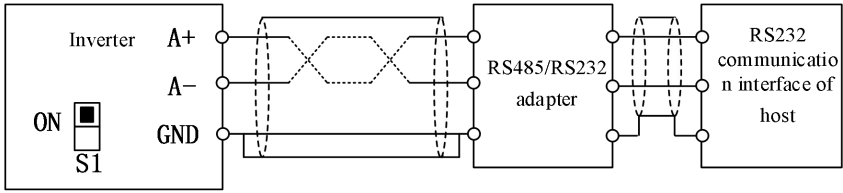

Fig. 3-18 Communication Terminal Wiring

### 3.4.3 Wire and screw dimensions of control circuit

- In order to reduce the interference and attenuation of the control signal, the control signal connection cable should be less than 50m long, and the distance between the control signal connection cable and power line should be greater than 30cm. Use the twisted-pair shielded cable when analog signals are externally inputted.
- It is recommended to use the wire with a diameter of 0.5-1 mm<sup>2</sup> in the control circuit.
- The terminal block of the EM730 series inverter is composed of through-type control circuit terminals. Install it with the PH0 Phillips screwdriver. The tightening torque should be 0.5N.m.

### 3.4.4 Precautions for control circuit wiring

- Connect the control circuit connection wires and other wires separately.
- Connect the control circuit terminals EA, EB, EC, and Y1 separately from other control circuit terminals.
- In order to avoid malfunction caused by interference, use the twisted shielded cables in the control circuit. The wiring distance should be less than 50m.
- Prevent the shield screen from contact with other signal lines and enclosures. The exposed shield screen can be wrapped with insulating tapes.
- It is prohibited to touch the ports and components of the control panel without static electricity protection measures.

### 3.4.5 Standard Wiring Diagram of Control Circuit

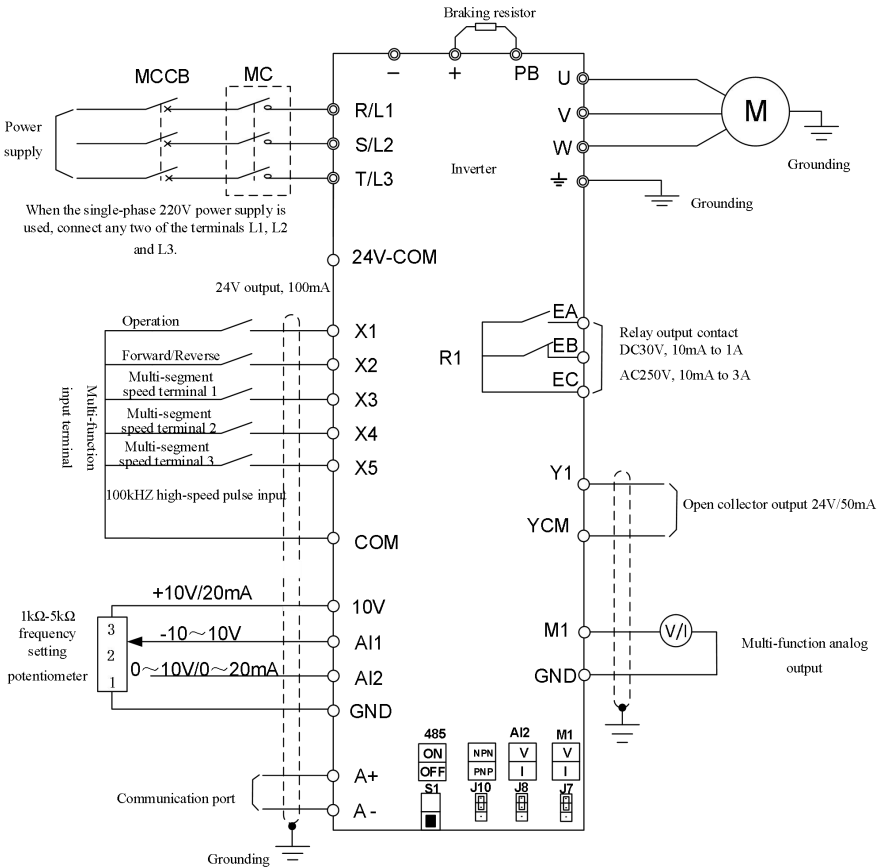

Fig. 3- 19 Standard Wiring Diagram of Control Circuit

- It is recommended to use the wires with a diameter of 0.5-1mm<sup>2</sup> in the control circuit.
- Install the control circuit terminals with the PH0 Phillips screwdriver. The tightening torque should be 0.5N.m.

### 3.5 Extend the keyboard wiring

- 1) The external keyboard needs to be ordered separately.
- 2) The external keyboard is connected to the RJ45 port via an ordinary network cable (plug: meeting the EIA/TIA568B standards) prepared by the customer.
- 3) Connect the RJ45 port of the keyboard to that of the control panel via a network cable. The keyboard extension cable should be no longer than 3m. Then extension cable may be 10m long in the presence of Cat5E wires and good electromagnetic environments.

### 3.6 Connection test

After wiring, check the following items.

- Check whether wiring is incorrect.
- Check whether there are screws, terminals and wire scraps inside the inverter.
- Check whether the screws are loose.
- Check whether the exposed wire at the stripped end of the terminal is in contact with other terminals.

# Chapter 4 KEYBOARD OPERATIONS

## 4.1 Keyboard Functions

### 4.1.1 Structure of LED keyboard

The control panel of EM730 series inverter is a pluggable LED keyboard. The LED keyboard has one five-digit LED digital display, four operation buttons, one digital potentiometer, and six status and unit indicators. Users can perform parameter setting, status monitoring and start/stop of the inverter via the keyboard.











Fig. 4-1 LED Keyboard



### 4.1.2 Functions of keys and indicators on LED keyboard

The functions of the keys and indicators on the LED keyboard are as shown in Table 4-1.

Table 4-1 Functions of Keys and Indicators on LED Keyboard

Key/Indicator	Name	Function
	Right	Select the group number and function number of the currently modified function code. Change the monitoring parameters.
	Back	Go back to the previous menu. Cancel the current parameter modification when the menu mode selection level is enabled from the monitoring level.
	Run	When the keyboard control is enabled, press this key to start the inverter.
	Stop/Reset	When the keyboard control is enabled, press this key to stop the inverter. Reset the protection in use.
	Potentiometer/ Confirm key	Turn it clockwise to select the function code and menu group or increase the parameter value. Increase the currently valid reference digital input data. Turn it counterclockwise to select the function code and menu group or decrease the parameter value. Decrease the currently valid reference digital input

		data. Click it to enter the lower-level menu. Confirm and save the parameter modification, and enable the function code following the current function code.
	Unit indicator	It is ON when the frequency, current, and voltage are displayed.
	Running direction indicator	This indicator is ON during reverse running. It is OFF during forward running. It is ON when a certain frequency is being monitored or displayed.
	Running indicator	It is ON when the inverter is running, flickering when the inverter is being stopped, and OFF after the inverter is stopped.
	Protection indicator	When the inverter is in the protection status, this indicator will be ON in red.



( and  below means that the potentiometer rotates clockwise and counterclockwise.)

## 4.2 Operation Mode of Keyboard with Digital Tube Display

The LED keyboard menu is divided into the monitoring level (Level 0), menu mode selection level (Level 1), function code selection level (Level 2) and parameter level (Level 3) from low to high. The menu levels mentioned below are represent by numbers.

There are five parameter display modes: menu mode (--A--), used to display all function codes; user-defined mode (--U--), used to display only function codes selected by the user based on the F11 group; non-default mode (--C--), used to display only the function codes that differ from the default settings;

Protection information display mode (--E--): display the current protection information; version information mode (--P--): display software and product serial numbers.

When the keyboard is powered on, the first monitoring parameter of Level 0 is displayed by default. Press the ESC key  to open the Level 1 menu. Users can use the keyboard  to select different menu modes. The process of menu mode selection is shown in Fig. 4-2.



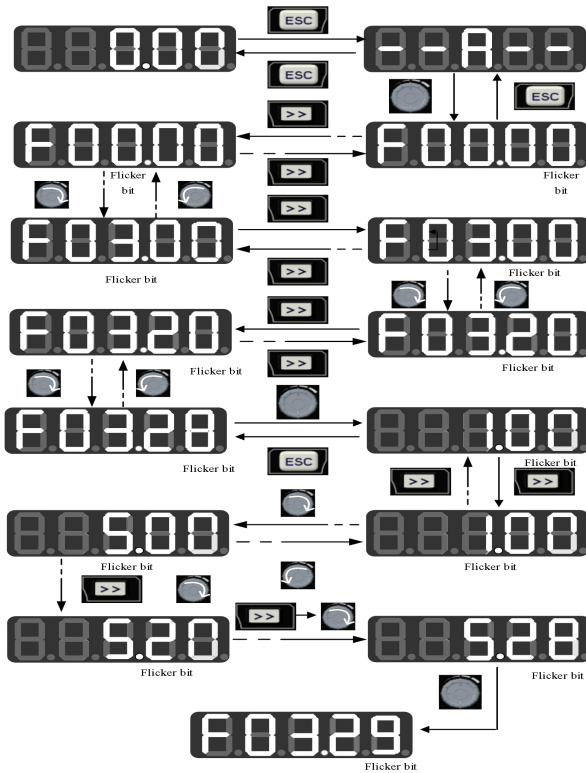



Fig. 4- 3 Flowchart from Power-on to F03.28=5.28 Setting

In all menu modes, the user needs to press the ENTER key  to save parameter modifications. Differences after parameter saving are as follows: In the full menu mode, enter the function code following the function code that has been successfully modified. In the user-defined mode, enter the user-defined function code (according to the sequence defined in F11.00-F11.31) following the function code that has been successfully modified. In the non-default mode, enter the non-default function code following the non-default function code that has been successfully modified. In the protection information display mode, enter the protection information function code following the protection information function code that has been successfully modified. In the version information display mode, enter the serial number

function code following the serial number function code has been successfully modified.

In the Level 3 menu, press the ESC key  to abandon parameter modifications.

**4.2.2 User-defined mode (—U—)**

Enter the F11 group of function codes from the full menu mode. Then the user can arbitrarily set the shortcut for the parameter to be accessed frequently. When F11.00 is enabled for the first time, U00.00 will be displayed by default, meaning that the function code defined by default for F11.00 is F00.00. The lowest cursor bit will flicker. The user can set any function code, similar to the function code selection in the Level 2 menu. After setting, press the ENTER key  to save it and enter the user-defined menu mode to display the set function code.

For example, F11.00 is set to U00.07 and F11.01 to U00.09. F11.00 and F11.01 will be defined as F00.07 and F00.09, respectively. They are distinguished by U and F. U indicates that this function code is user-defined, as shown in Fig. 4-4.

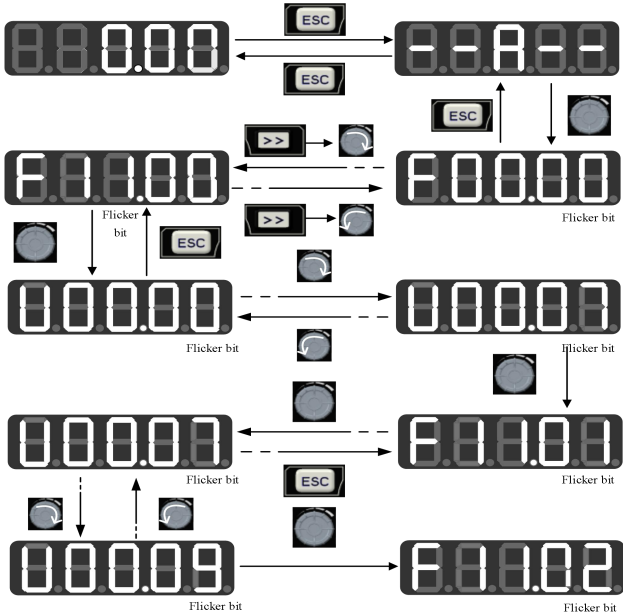



Fig. 4-4 Example of User-defined Mode Setting



In the user-defined mode, press the ENTER key  to enter the Level 2 menu. The Level 2 menu only display 32 user-defined parameters in the F11 group. The user can enter the F11 group from the full menu mode to set these function codes.

After the function codes are defined in the F11 group, enter the user-defined mode. Then







we can see F00.07 defined by the first function code F11.00, F00.09 defined by the first function code F11.01, and so on to F11.31, 32 in total. Function code modification in the Level 3 menu is equivalent to that in the full menu mode, and the modification method is also the same.

In the Level 2 menu of the user-defined mode, turn the potentiometer key  on the keyboard, to change the function code defined by F11.00 to that defined by F11.31.

When the right shift key  is pressed in the Level 2 menu, the cursor will not shift. Press the ENTER key  to enter the Level 3 menu. If the displayed function code is modifiable currently, the lowest bit indicated by the cursor will flicker. Parameter modification is the same as that in the Level 3 menu under the full menu mode. After modification, press the ENTER key to confirm and save the parameters and enable next user-defined parameter. Function code modifications in the Level 3 menus under different menu modes have equivalent effects.

#### 4.2.3 Non-default mode (←C→)

In the non-default mode, press the ENTER key to enter the Level 2 menu. The first parameter different from the default settings of the inverter will be displayed, starting from F00.00. When the right shift key  is pressed in the Level 2 menu, the cursor will not shift. If the increment or decrement key on the keyboard is pressed, the function group and function code will not be modified, and the non-default function code following and in front of the current function code will be displayed respectively. If the displayed function code is modifiable currently in the Level 3 menu, the lowest bit indicated by the cursor will flicker. In this case, parameters can be modified in the Level 3 menu under the full menu mode. After modification, press the ENTER key  to confirm and save the parameters and enable next non-default parameter.

For example, change F00.03 to 1 and F00.07 to 40.00 in the full menu mode, which are not default values. Then enable the non-default mode. F00.03 will be displayed first. When the potentiometer key  on the keyboard is turned clockwise, F00.07 will be displayed; and when the potentiometer key  on the keyboard is turned counterclockwise, F00.03 will be returned, as shown below:









parameter will automatically change from the current value to that indicated by F12.33. When the inverter changes from the running status to stop status, the monitoring parameter will automatically change from the current value to that indicated by F12.34.

### 4.4.2 Editing Mode

Quick change in the monitoring mode:

When F00.04 is set to “0: digital frequency setting F00.07”, turn the potentiometer key  to directly change the offset;

When F00.04 is set to “8: digital potentiometer”, turn the potentiometer key  to change the set frequency of F12.42 digital potentiometer. In this case, turn the potentiometer key  to enter the editing mode. The value will change from the second digit of the digital tube by default. The digital tube corresponding to the changed digit will flash. Press the right shift key  to move to next digit on the right. Press the ESC key  to cancel change and return to the original value. Or, press the ENTER key  to confirm the change and exit the editing mode. The indicator will not be flicker. Press the right shift key  to enable the normal monitoring mode: switch to next monitoring parameter. Fig. 4-6 shows the editing status in the monitoring mode.

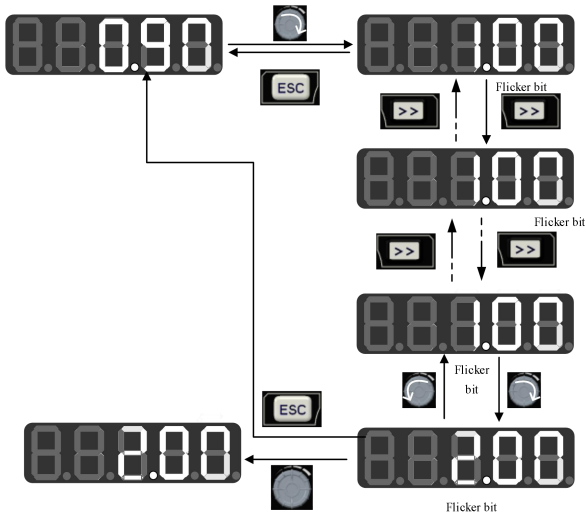



Fig. 4-6 Editing Status in the Monitoring Mode

### 4.5 Run/Stop

After setting the parameters, press the RUN key  to enable the normal operation of the inverter, and the STOP/RESET key  to stop the inverter.

## **4.6 Other Warning Prompts**

### **4.6.1 P. -ON prompt**

The P. -ON prompt will be displayed after power-on initialization.

### **4.6.2 P. -OFF prompt**

When the voltage drops to 250V (with the soft start disconnected), P-OFF will be displayed, and the keyboard can be operated freely to exit the P. -OFF display and display normal information.

In case of no keyboard operation within 5s, P-OFF will be displayed again. After the voltage is restored and the soft start is engaged, P. -ON will be displayed again.

### **4.6.3 SOFT. E warning**

If the soft start is not engaged and the inverter is started, the SOFT. E warning will appear. After the voltage is restore and the soft start is engaged, normal operation will be enabled.

# Chapter 5 Trial run

## 5.1 Inverter Commissioning Process

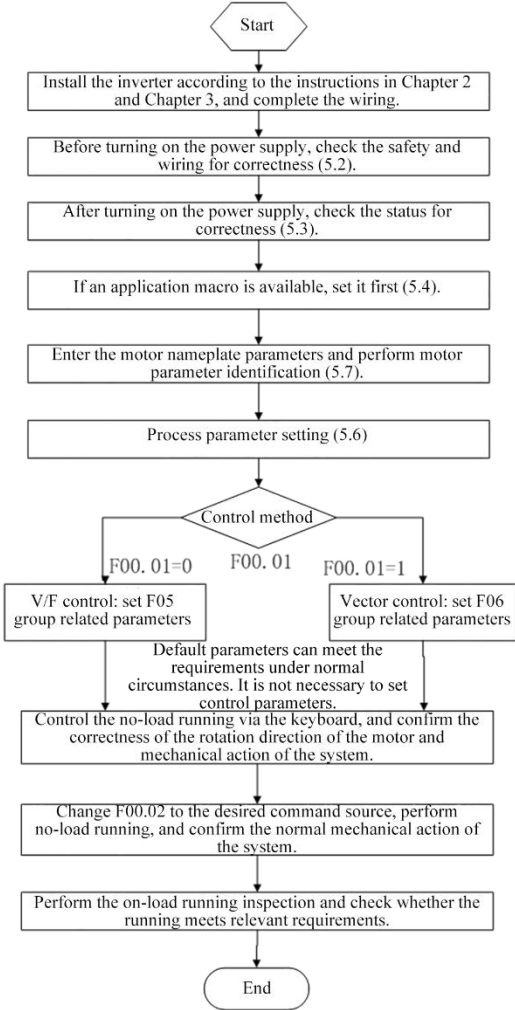

Fig. 5-1 Inverter Commissioning Flowchart

## 5.2 Confirmation before Power-on

Please confirm the following items before turning on the power supply:

Item to be confirmed	Confirmation content
Power wiring confirmation	Check whether the input power voltage is consistent with the voltage of the inverter.
	Confirm that the circuit breaker has been connected to the power supply circuit, and the power cables are correctly connected to the input terminals (R, S, T) of the inverter.
	Make sure that the inverter and motor are properly grounded.
Motor wiring confirmation	Confirm that the motor is correctly connected to the output terminals (U, V, W) of the inverter, and the motor wiring is secured.
Confirmation of braking unit and braking resistor	Make sure that the braking resistor and braking unit are connected as shown in Fig. 3-3 (use the dynamic braking resistor if necessary during operation).
Control terminal wiring confirmation	Check whether the control terminals of the inverter are correctly and reliably connected to other controls.
Control terminal status confirmation	Make sure that the control terminal circuit of the inverter is disconnected to prevent operation upon powering on.
Mechanical load confirmation	Confirm that the machinery is in the no-load state and free of danger in operation.

## 5.3 Inverter Status Confirmation after Power-on

After the power supply is turned on, the control panel (keyboard) of the inverter displays the following information in the normal status.

Status	Display	Note
During normal operation	0	The digital setting 0Hz is displayed by default
Protection	Protection code in character or Exx format	The protection code is displayed in the protection status. See the protection measures in Chapter 6.

## 5.4 Precautions for Application Macro Setting

F16.00 is an industry application macro option. Select the application macro according to the specific application, and press the Enter key to automatically restore default settings. See Chapter 10 for details on application macros.

## 5.5 Start and Stop Control

Function code	Function code name	Parameter description	Default setting	Attribute
F00.02	Options of command source	0: keyboard control 1: Terminal control 2: Communication control	0	○

### F00.02=0: keyboard control

The start and stop of the inverter are controlled by the RUN key, STOP key on the keyboard. In the case of no trip protection, press the RUN key to enter the running status. If the green LED indicator above the RUN key is normally ON, it indicates that the inverter is running. If this indicator is flickering, it indicates that the inverter is in the status of deceleration to stop.

### F00.02=1: terminal control

The inverter start and stop are controlled by the start and stop control terminals defined by the function code F02.00 to F02.04. Terminal control is dependent on F00.03.

### F00.02=2: communication control

The inverter start and stop are controlled by the host through the RS485 communication port.

Function code	Function code name	Parameter description	Default setting	Attribute
F04.00	Start-up method	0: direct start 1: start of speed tracking	0	○

### F04.00=0: direct start

The inverter is started at the starting frequency, following the DC braking (not suitable when F04.04=0) and pre-excitation (not suitable when F04.07=0). The starting frequency will change to the set frequency after the holding time.

### F04.00=1: start with speed tracking

The inverter is smoothly started at the current rotating frequency of the motor, following the speed tracking.

Function code	Function code name	Parameter description	Default setting	Attribute
F04.19	Stop mode	0: Slow down to stop 1: Free stop	0	○

### F04.19=0: deceleration to stop

The motor decelerates to stop according to the set deceleration time [default setting: based on F00.15 (deceleration time 1)].

### F04.19=1: free stop

When there is a valid stop command, the inverter will stop output immediately, and the motor will freely coast to stop. The stop time depends on the inertia of the motor and load.

5.5.1 Terminal control of start and stop

Function code	Function code name	Parameter description	Default setting	Attribute
F00.03	Options of terminal control mode	0: terminal RUN (running) and F/R (forward/reverse) 1: terminal RUN (forward) and F/R (reverse) 2: terminal RUN (forward), Xi (stop) and F/R (reverse) 3: terminal RUN (running), Xi (stop) and F/R (forward/reverse)	0	○

**Terminal RUN:** Xi terminal is set to “1: terminal RUN”

**Terminal F/R:** Xi terminal is set to “2: running direction F/R”

**Terminal control can be divided into two types: two-line control and three-line control.**

**Two-line control:**

**F00.03=0: the terminal RUN is enabled and the terminal F/R controls forward/reverse running.**

Enable/Disable the terminal RUN to control the start and stop of the inverter, and the terminal F/R to control the forward/reverse running. If F00.21 is set to 1 and reverse running is disabled, the F/R terminal will not be available. When the mode of deceleration to stop is selected, the logic diagram is as shown in Fig. 5-2 (b).

**F00.03=1: the terminal RUN controls forward running, and the terminal F/R is in the reverse mode.**

Enable/Disable the terminal RUN to control the forward running and stop of the inverter, and the terminal F/R to control the reverse running and stop. When the terminals RUN and F/R are enabled simultaneously, the inverter will be stopped. If reverse running is disabled, the terminal F/R will not be available. When the mode of deceleration to stop is selected, the logic of forward/reverse running is as shown in Fig. 5-2 (d):

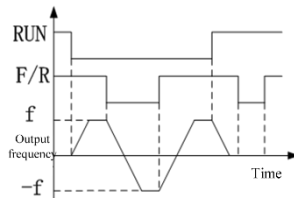
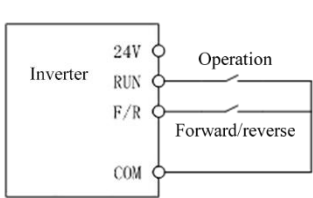

(a) Wiring diagram of two-line control (F00.03=0) (b) F04.19=0, F00.03=0, run the forward/reverse logic



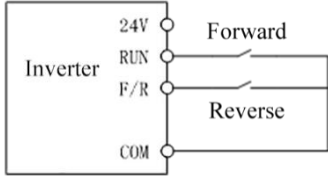

(c) F00.03=1 two-line control wiring

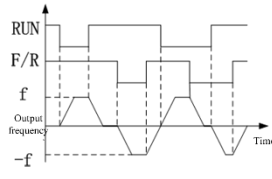

(d) F04.19=0, F00.03=1:

forward/reverse running logic

Fig. 5-2 Two-line Control

When the start/stop value of F00.03 is set to 0 or 1, even if the terminal RUN is available, the inverter can be stopped by pressing the STOP key  or sending an external stop command to the terminal. In this case, the inverter will not be in the running status until the terminal RUN is disabled and then enabled.

**Three-line control:**

**F00.03=2: the terminal RUN controls forward running, the terminal Xi is for stop, and the terminal F/R is in the reverse status.**

The terminal RUN is normally ON for forward running, and the terminal F/R is normally ON for reverse running, with valid pulse edges. The terminal Xi is normally closed for stop, with the valid level. When the inverter is in the running status, press Xi to stop it. In the case of deceleration to stop (F04.19=0), the logic diagram is as shown in Fig. 5-3 Fig. 7-7(b). The terminal Xi is for “three-line running and stop control” as defined by F02.00 to F02.04.

**F00.03=3: the terminal RUN is for running, Xi for stop and F/R for forward/reverse control.**

The terminal RUN is normally ON for running, with the valid pulse edge, F/R for forward/reverse switching (forward in the OFF status and reverse in the ON status), and Xi is normally OFF for stop, with the valid level. In the case of deceleration to stop (F04.19=0), the logic diagram is as shown in Fig. 5-3(d).

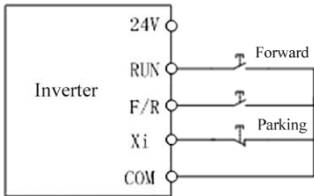

(a) Wiring diagram of three-line control (F00.03=2)

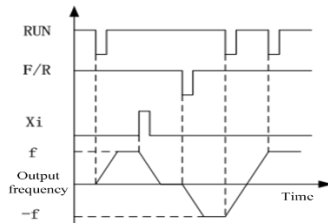

(b) Forward/reverse control logic

(F04.19=0, F00.03=2)

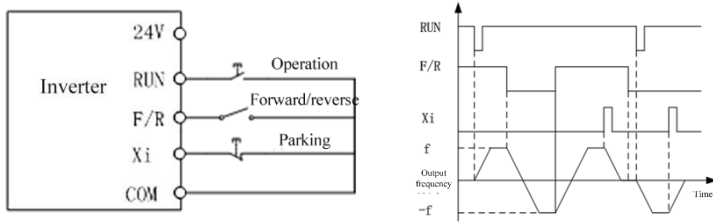

(c) Wiring diagram of three-line control (F00.03=3) (d) Forward/reverse running logic

(F04.19=0, F00.03=3)

Fig. 5-3 Three-line Control

The three-line control logic of the EM730 series inverter is consistent with the conventional electrical control. The keys and knob switches should be used correctly as shown in the schematic diagram. Otherwise, operation errors may be caused.

### 5.6 Common Process Parameters of Inverter

Function code	Function code name	Parameter description	Unit	Default setting	Attribute
F00.01	Drive control mode of motor 1	0: V/F control (VVF) 1: Speed sensorless vector control (SVC)		0	○
F00.04	Options of main frequency source A	0: digital frequency setting F00.07 1: AI1 2: AI2 5: high frequency pulse input (X5) 6: percentage setting of main frequency communication 7: direct setting of main frequency communication 8: digital potentiometer setting		8	○
F00.07	Digital frequency setting	0.00 to maximum frequency F00.16	Hz	0.00	●
F00.14	Acceleration time 1	0.00~650.00 (F15.13=0)	s	15.00	●
F00.15	Deceleration time 1	0.00~650.00 (F15.13=0)	s	15.00	●
F00.16	Maximum frequency	1.00~600.00	Hz	50.00	○
F00.18	Upper frequency limit	lower frequency limit F00.19 to maximum frequency F00.16	Hz	50.00	●
F00.19	Lower frequency limit	0.00 to upper frequency limit F00.18	Hz	0.00	●
F00.21	Reverse control	0: allow forward/reverse running 1: prohibit reversing		0	○

Note: Common process parameters may also include the input and output terminal function settings. Refer to the F02 and F03 groups in the function table.

### 5.7 Motor Parameter Identification

For the better control performance, motor parameters must be identified.

Identification Method	Application	Identification Effect
F01.34=1 Static self-learning of asynchronous motor	It is applied where the motor and load cannot be separated easily and rotary self-learning is not allowed.	General
F01.34=11 Static self-learning of synchronous motor		
F01.34=2 Rotary self-learning of asynchronous motor	It is applied when the motor and load can be separated easily. Before operation, the motor shaft should be separated from the load. The motor under load must not be put into rotary self-learning.	Optimal
F01.34=12 Rotary self-learning of synchronous motor		

- Prior to self-identification, make sure that the motor is stopped; otherwise, self-identification cannot be performed properly.

#### 5.7.1 Parameter identification steps

- Where the motor and load can be separated, the mechanical load and motor should be completely separated in the power-off status.
- After the power-on, set the command source of the inverter to keyboard control (F00.02=0).
- Enter the nameplate parameters of the motor accurately.

Motor	Corresponding Parameter
Motor 1	F01.00 Motor type F01.01 Rated power of electric motor F01.02 Rated voltage of motor F01.03 Rated current of motor F01.04 Rated frequency of motor F01.05 Rated speed F01.06 Motor winding connection
Motor 2	F14.00 Motor type F14.01 Rated power of electric motor F14.02 Rated voltage of motor F14.03 Rated current of motor F14.04 Rated frequency of motor F14.05 Rated speed F14.06 Motor winding connection

- For the asynchronous motor:

- Set F01.34=1 for confirmation and press the RUN key. The inverter will start the static self-identification of the motor.
- Or, set F01.34=2 and press the RUN key. The inverter will start the rotary self-identification of the motor.
- For the synchronous motor:
- Set F01.34=11 and press the RUN key. The inverter will start the static self-identification of the motor.
- Or, set F01.34=12 and press the RUN key. The inverter will start the rotary self-identification of the motor.
- It takes about two minutes to complete the self-identification of the motor. Then the system will return to the initial power-on status from the “tune” interface.
- If multiple motors are used in parallel, the rated power and rated current input of the motors should be the sum of power and current of these motors.
- If two motors are used alternately, the parameters of the motor 2 in the F14 group need to be set separately, and identified based on F14.34.

## Chapter 6 Function Code Table

### 6.1 Description of Function Code Table

The function codes of the EM730 series inverter (hereinafter referred to as the “function codes”) are divided into 22 groups in Table 6-2, and each group contains several function codes. Among them, the F18 group is a monitoring parameter group used to view the inverter status; the F19 group is a protection record group used to view the details of the last three protections; and other groups are parameter setting groups to meet different functional requirements.

Table 6-2 Introduction to Function Code Groups

F00	Basic function parameter group	P69; P136	F01	Parameter group of motor 1	P72; P154
F02	Input terminal function group	P72; P154	F03	Output terminal function group	P80; P173
F04	Start/stop control parameter group	P82; P197	F05	V/F control parameter group	P84; P205
F06	Vector control parameter group	P86; P211	F07	Protection function setting group	P90; P218
F08	Multi-segment speed and simple PLC	P92; P227	F09	PID function group	P98; P237
F10	Communication function group	P101; P251	F11	User-selected parameter group	P102; P256
F12	Keyboard and display function group	P104; P258	F13	Torque control parameter group	P107; P264
F14	Parameter group of motor 2	P108; P270	F15	Auxiliary function group	P114; P273
F16	Customization function group	P117; P287	F17	Virtual I/O function group	P119; P309
F18	Monitoring parameter group	P122; P313	F19	Protection record group	P124; P317
F27	Winding/unwinding application macro parameter group	P126; P290	F45	Modbus free mapping parameter group	P129; P306

- ★ Some parameters of the current series are reserved, and their readings are 0. Some options of parameters are reserved and settable, but this may result in abnormal operation of the inverter. Please avoid misuse of such parameters.

The table below provides the details of the function code table.

<b>Function code</b>	F00.00 to F99.99: function code number					
<b>Function code name</b>	Full name of the function code. “Reserved” means that the corresponding function code is temporarily reserved and has no practical meaning.					
<b>Parameter description</b>	Brief description of the function code. It is mainly divided into the following three types:					
	Integral	The value of the integral function code represents the current parameter selection or meaning.				
	Quantifier	The ones, tens, hundreds, thousands and tens of thousands represent one option or the current meaning of the function code.				
	Binary	Each binary bit represents one option or the current meaning of the function code.				
<b>Unit</b>	Metric units of the function code. The units and abbreviations are as follows:					
	Hz	Hertz	kW	kilowatt	us	Microsecond
	kHz	Kilohertz	kWh	Kilowatt-hour★	ms	Millisecond
	%	Percent★	MWh	Megawatt hour	s	Second
	V	Volt	mΩ	Milliohm	min	min
	A	Amp	mH	Millihenry	h	h
	rpm	rpm	°C	°C	m	m
★: %: The benchmarks are different for physical quantities; kWh: Kilowatt hour, commonly known as the degree.						
<b>Default setting</b>	Function code settings before delivery, or values after parameter restoration (F12.14=1). This is mainly described by the following three categories.					
	Number (e.g. 50.00)	Refer to each power segment. The function code is set to the current value by default.				
	Depending on the motor type	The default setting of this function code varies based on the power segments.				
	XXX	The default setting of this function code varies based on the power segments and batches.				

<b>Attribute</b>	Change attribute of the function code (permission and condition of change), as described below:	
	●	Changeable in running: The current function code can be changed in any status.
	○	Non-changeable in running: The current function code can be changed except in the running status.
	×	Read-only: The current function code cannot be changed in any status.

## 6.2 Table of functional parameters

Function code	Function code name	Parameter description	Unit	Default setting	Attribute	mailing address
<b>F00</b>	<b>Basic function parameter group</b>					
F00.00	Reserved					
F00.01	Drive control mode of motor 1	0: v/f control (VVF) 1: speed sensorless vector control (SVC)		0	○	0x0001
F00.02	Options of command source	0: keyboard control (LOC/REM indicator: ON) 1: terminal control (LOC/REM indicator: OFF) 2: communication control (LOC/REM indicator: flicker)		0	○	0x0002
F00.03	Options of terminal control mode	0: terminal RUN (running) and F/R (forward/reverse) 1: terminal RUN (forward) and F/R (reverse) 2: terminal RUN (forward), Xi (stop) and F/R (reverse) 3: terminal RUN (running), Xi (stop) and F/R (forward/reverse)		0	○	0x0003
F00.04	Options of main frequency source A	0: digital frequency setting F00.07 1: AI1 2: AI2 3: reserved 4: reserved 5: high frequency pulse input (X5) 6: main frequency communication setting (percentage) 7: main frequency communication setting (direct frequency) 8: digital potentiometer setting		8	○	0x0004
F00.05	Options of auxiliary	0: digital frequency setting F00.07 1: AI1		0	○	0x0005

	frequency source B	2: AI2 3: reserved 4: reserved 5: high frequency pulse input (X5) 6: auxiliary frequency communication setting (percentage) 7: auxiliary frequency communication setting (direct frequency) 8: digital potentiometer setting 9: reserved 10: process PID 11: simple PLC				
F00.06	Options of frequency source	0: main frequency source A 1: auxiliary frequency source B 2: main and auxiliary operation results 3: switching between main frequency source A and auxiliary frequency source B 4: switching between main frequency source A and main and auxiliary operation results 5: switching between auxiliary frequency source B and main and auxiliary operation results 6: auxiliary frequency source B + feedforward calculation (winding application)		0	○	0x0006
F00.07	Digital frequency setting	0.00 to maximum frequency F00.16	Hz	50.00	●	0x0007
F00.08	Options of main and auxiliary operation	0: main frequency source A + auxiliary frequency source B 1: main frequency source A - auxiliary frequency source B 2: larger value of main and auxiliary frequency sources 3: smaller value of main and auxiliary frequency sources 4: main frequency source A - auxiliary frequency source B, the operation result is greater than or equal to zero 5: main frequency source A + auxiliary frequency source B, the operation result is greater than or equal to zero		0	○	0x0008
F00.09	Reference options of	0: relative to the maximum frequency 1: relative to main frequency source A		0	○	0x0009



	auxiliary frequency source B in main and auxiliary operation					
F00.10	Gain of main frequency source	0.0~300.0	%	100.0	●	0x000A
F00.11	Gain of auxiliary frequency source	0.0~300.0	%	100.0	●	0x000B
F00.12	Synthetic gain of main and auxiliary frequency sources	0.0~300.0	%	100.0	●	0x000C
F00.13	Analog adjustment of synthetic frequency	0: synthetic frequency of main and auxiliary channels 1: AI1 * synthetic frequency of main and auxiliary channels 2: AI2 * synthetic frequency of main and auxiliary channels 3: reserved 4: reserved 5: high frequency pulse (PULSE) * synthetic frequency of main and auxiliary channels		0	○	0x000D
F00.14	Acceleration time 1	0.00 ~ 650.00 (F15.13=0) 0.0 ~ 6500.0 (F15.13=1) 0 ~ 65000 (F15.13=2)	s	15.00	●	0x000E
F00.15	Deceleration time 1	0.00 ~ 650.00 (F15.13=0) 0.0 ~ 6500.0 (F15.13=1) 0 ~ 65000 (F15.13=2)	s	15.00	●	0x000F
F00.16	Maximum frequency	1.00~600.00/1.0~3000.0	Hz	50.00	○	0x0010
F00.17	Options of upper frequency limit control	0: set by F00.18 1: AI1 2: AI2 3: reserved 4: reserved 5: high frequency pulse input (X5) 6: communication setting (percentage)		0	○	0x0011

		7: communication setting (direct frequency)				
F00.18	Upper frequency limit	lower frequency limit F00.19 to maximum frequency F00.16	Hz	50.00	●	0x0012
F00.19	Lower frequency limit	0.00 to upper frequency limit F00.18	Hz	0.00	●	0x0013
F00.20	Running direction	0: consistent direction 1: opposite direction		0	●	0x0014
F00.21	Reverse control	0: allow forward/reverse running 1: prohibit reversing		0	○	0x0015
F00.22	Duration of forward and reverse dead zone	0.00~650.00	s	0.00	●	0x0016
F00.23	Carrier frequency	1.0 ~ 16.0 (rated power of the inverter: 0.75-4.00kW) 1.0 ~ 10.0 (rated power of the inverter: 5.50~7.50kW) 1.0 ~ 8.0 (rated power of inverter 11.00 - 45.00kW) 1.0 ~ 4.0 (rated power of inverter 55.00 - 90.00kW) 1.0 ~ 3.0 (rated power of inverter: 110.00 and above)	kHz	4.0 (0.75 and below ) /2.0	●	0x0017
F00.24	Automatic adjustment of carrier frequency	0: invalid 1: valid 1 2: valid 2		1	○	0x0018
F00.25	Noise suppression of carrier frequency	0: invalid 1: noise suppression of carrier frequency mode 1 2: noise suppression of carrier frequency mode 2		0	○	0x0019
F00.26	Noise suppression width	1~20	Hz	1	●	0x001A
F00.27	Noise suppression intensity	0: invalid 0~10: noise suppression of carrier frequency mode 1 0~ 4: noise suppression of carrier frequency mode 2	%	2	●	0x001B
F00.28	Options of	0: parameter group of motor 1		0	○	0x001C

	motor parameter group	1: parameter group of motor 2				
F00.29	User password	0 ~ 65535		0	○	0x001D
F00.31	Frequency resolution	0: 0.01Hz 1: 0.1Hz (speed unit: 10rpm)		0	○	0x001E
F00.35	Power supply voltage selection	0: 380V 1: 440V		0	○	0x0023
<b>F01</b>	<b>Parameter group of motor 1</b>					
F01.00	Motor type	0: ordinary asynchronous motor 1: variable-frequency asynchronous motor 2: permanent magnet synchronous motor		0	○	0x0100
F01.01	Rated power of electric motor	0.10~650.00	kW	Depen ding on the motor type	○	0x0101
F01.02	Rated voltage of motor	50~2000	V	Depen ding on the motor type	○	0x0102
F01.03	Rated current of motor	1~60000 (rated power of motor: ≤ 75 kW) 0.1~6000.0 (rated power of motor: > 75kW)	A	Depen ding on the motor type	○	0x0103
F01.04	Rated frequency of motor	0.01~600.00	Hz	Depen ding on the motor type	○	0x0104
F01.05	Rated speed	1~60000	rpm	Depen ding on the motor type	○	0x0105
F01.06	Motor winding connection	0:Y 1:Δ		Depen ding on the motor type	○	0x0106

F01.07	Rated power factor of motor	0.600~1.000		Depending on the motor type	○	0x0107
F01.08	Motor efficiency	30.0~100.0	%	Depending on the motor type	○	0x0108
F01.09	Stator resistance of asynchronous motor	1~60000 (rated power of motor: ≤ 75 kW) 0.1~6000.0 (rated power of motor: > 75kW)	mΩ	Depending on the motor type	○	0x0109
F01.10	Rotor resistance of asynchronous motor	1~60000 (rated power of motor: ≤ 75 kW) 0.1~6000.0 (rated power of motor: > 75kW)	mΩ	Depending on the motor type	○	0x010A
F01.11	Leakage inductance of asynchronous motor	0.01 to 600.00 (rated power of motor: ≤ 75 kW) 0.001 to 60.000 (rated power of motor: > 75 kW)	mH	Depending on the motor type	○	0x010B
F01.12	Mutual inductance of asynchronous motor	0.1 to 6000.0 (rated power of motor: ≤ 75 kW) 0.01 to 600.00 (rated power of motor: > 75 kW)	mH	Depending on the motor type	○	0x010C
F01.13	No-load excitation current of asynchronous motor	0.01 to 600.00 (rated power of motor: ≤ 75 kW) 0.1 to 6000.0 (rated power of motor: > 75 kW)	A	Depending on the motor type	○	0x010D
F01.14	Flux weakening coefficient 1 of asynchronous motor	10.00 ~ 100.00	%	87.00	○	0x010E
F01.15	Flux weakening	10.00 ~ 100.00	%	80.00	○	0x010F

	coefficient 2 of asynchronous motor					
F01.16	Flux weakening coefficient 3 of asynchronous motor	10.00 ~ 100.00	%	75.00	○	0x0110
F01.17	Flux weakening coefficient 4 of asynchronous motor	10.00 ~ 100.00	%	72.00	○	0x0111
F01.18	Flux weakening coefficient 5 of asynchronous motor	10.00 ~ 100.00	%	70.00	○	0x0112
F01.19	Stator resistance of synchronous motor	1~ 60000 (rated power of motor: ≤75kW) 0.1 to 6000.0 (rated power of motor: > 75 kW)	mΩ	Depen ding on the motor type	○	0x0113
F01.20	d-axis inductance of synchronous motor	0.01 to 600.00 (rated power of motor: ≤ 75 kW) 0.001 to 60.000 (rated power of motor: > 75 kW)	mH	Depen ding on the motor type	○	0x0114
F01.21	q-axis inductance of synchronous motor	0.01~600.00 (rated power of motor: ≤ 75 kW) 0.001~60.000 (rated power of motor: > 75kW)	mH	Depen ding on the motor type	○	0x0115
F01.22	Counter electromotive force of synchronous motor	10.0 ~ 2000.0 (counter electromotive force of rated speed)	V	Depen ding on the motor type	○	0x0116
F01.23	Initial	0.0 ~ 359.9 (valid for synchronous motor)			○	0x0117

	electrical angle of synchronous motor					
F01.34	Motor parameter self-learning	00: no operation 01: static self-learning of asynchronous motor 02: rotation self-learning of asynchronous motor 03: inertia self-learning of asynchronous motor 11: static self-learning of synchronous motor 12: rotary self-learning of synchronous motor 13: encoder self-learning of synchronous motor		00	○	0x0122
<b>F02</b>	<b>Input terminal function group</b>					
F02.00	Options of X1 digital input function	0: no function 1: terminal running (RUN) 2: running direction (F/R)		1	○	0x0200
F02.01	Options of X2 digital input function	3: stop control in three-line operation 4: forward jog (FJOG) 5: reverse jog (RJOG)		2	○	0x0201
F02.02	Options of X3 digital input function	6: terminal UP 7: terminal DOWN 8: clear UP/DOWN offset		11	○	0x0202
F02.03	Options of X4 digital input function	9: free stop 10: reset protection 11: multi-segment speed terminal 1		12	○	0x0203
F02.04	Options of X5 digital input function	12: multi-segment speed terminal 2 13: multi-segment speed terminal 3 14: multi-segment speed terminal 4		13	○	0x0204
F02.07	Options of AI1 digital input function	15: multi-segment PID terminal 1 16: multi-segment PID terminal 2 17: multi-segment torque terminal 1		0	○	0x0207
F02.08	Options of AI2 digital input function	18: multi-segment torque terminal 2 19: acceleration and deceleration time terminal 1 20: acceleration and deceleration time terminal 2 21: acceleration and deceleration prohibition 22: operation pause 23: external protection input 24: switching of RUN command to keyboard 25: switching of RUN command to communication 26: frequency source switching		0	○	0x0208

	<p>27: clearing of regular running time                  28: speed control/torque control switching                  29: torque control prohibition                  30: motor 1/motor 2 switching                  31: resetting of simple PLC status (running from the first segment, with the running time cleared)                  32: simple PLC time pause (keep running at current segment)                  33: reserved                  34: counter input (<math>\leq 250\text{Hz}</math>)                  35: high-speed count input (<math>\leq 100\text{kHz}</math>, only valid for X5)                  36: count clearing                  37: length counter input (<math>\leq 250\text{Hz}</math>)                  38: High-speed length counting input (<math>\leq 100\text{kHz}</math>, only valid for X5)                  39: reset length (clear by meter)                  40: pulse input (<math>\leq 100\text{kHz}</math>, only valid for X5)                  41: process PID pause                  42: process PID integral pause                  43: PID parameter switching                  44: PID positive/negative switching                  45: stop and DC braking                  46: DC braking at stop                  47: immediate DC braking                  48: fastest deceleration to stop                  49: reserved                  50: external stop                  51: switching of main frequency source to digital frequency setting                  52: switching of main frequency source to AI1                  53: switching of main frequency source to AI2                  54: reserved                  55: switching of main frequency source to high-frequency pulse input                  56: switching of main frequency source to communication setting                  57: inverter enabling                  58: prohibit reversing and prohibit enabling                  68: disable reversal                  69: prohibit reversing                  70: input terminal expansion                  121: external material cutoff signal</p>				
--	---	--	--	--	--

		122: wiring detection signal 123: brake reset terminal												
F02.15	Positive/negative logic 1 of digital input terminal	D7	D6	D5	D4	D3	D2	D1	D0	00000	○	0x020F		
		*	*	*	X5	X4	X3	X2	X1					
		0: positive logic, valid in the closed state/invalid in the open state 1: negative logic, invalid in the closed state/valid in the open state												
F02.16	Positive/negative logic 2 of digital input terminal	D7	D6	D5	D4	D3	D2	D1	D0	00	○	0x0210		
		*	*	*	*	*	*	AI2	AI1					
		0: positive logic, valid in the closed state/invalid in the open state 1: negative logic, invalid in the closed state/valid in the open state												
F02.17	Filtering times of digital input terminal	0~100, 0: no filtering; n: sampling every n ms									2	○	0x0211	
F02.18	X1 valid delay time	0.000~30.000									s	0.000	●	0x0212
F02.19	X1 invalid delay time	0.000~30.000									s	0.000	●	0x0213
F02.20	X2 valid delay time	0.000~30.000									s	0.000	●	0x0214
F02.21	X2 invalid delay time	0.000~30.000									s	0.000	●	0x0215
F02.22	X3 valid delay time	0.000~30.000									s	0.000	●	0x0216
F02.23	X3 invalid delay time	0.000~30.000									s	0.000	●	0x0217
F02.24	X4 valid delay time	0.000~30.000									s	0.000	●	0x0218
F02.25	X4 invalid delay time	0.000~30.000									s	0.000	●	0x0219
F02.26	Minimum input pulse	0.00 to maximum input pulse frequency F02.28									kHz	0.00	●	0x021A



	frequency					
F02.27	Minimum input setting	-100.0 ~ +100.0	%	0.0	●	0x021B
F02.28	Maximum input pulse frequency	0.01~100.00	kHz	50.00	●	0x021C
F02.29	Maximum input setting	-100.0 ~ +100.0	%	100.0	●	0x021D
F02.30	Pulse input filtering time	0.00 ~ 10.00	s	0.10	●	0x021E
F02.31	Options of analog input function	Ones place: AI1 0: analog input 1: digital input (0 below 1V, 1 above 3V, the same as last time under 1-3V) Tens place: AI2 0: analog input 1: digital input (the same as above)		00B	○	0x021F
F02.32	Options of analog input curve	Ones place: Options of AI1 curve 0: curve 1 1: curve 2 2: curve 3 3: curve 4 Tens place: AI2 curve selection 0: curve 1 1: curve 2 2: curve 3 3: curve 4		10	○	0x0220
F02.33	Minimum input of curve 1	-10 ~ F02.35	V	0.10	●	0x0221
F02.34	Minimum input setting of curve 1	-100.0 ~ +100.0	%	0.0	●	0x0222
F02.35	Maximum input of curve 1	-10~10.00V	V	9.90	●	0x0223
F02.36	Maximum input setting of curve 1	-100.0~ +100.0	%	100.0	●	0x0224
F02.37	Minimum input of curve 2	-10.00V~F02.39	V	0.10	●	0x0225
F02.38	Minimum	-100.0 ~ +100.0	%	0.0	●	0x0226

	input setting of curve 2					
F02.39	Maximum input of curve 2	F02.37~10.00V	V	9.90	●	0x0227
F02.40	Maximum input setting of curve 2	-100.0 ~ +100.0	%	100.0	●	0x0228
F02.41	Minimum input of curve 3	-10.00V ~ F02.43	V	0.10	●	0x0229
F02.42	Minimum input setting of curve 3	-100.0 ~ +100.0	%	0.0	●	0x022A
F02.43	Input of inflection point 1 of curve 3	F02.41 ~ F02.45	V	2.50	●	0x022B
F02.44	Input setting of inflection point 1 of curve 3	-100.0 ~ +100.0	%	25.0	●	0x022C
F02.45	Input of inflection point 2 of curve 3	F02.43 ~ F02.47	V	7.50	●	0x022D
F02.46	Input setting of inflection point 2 of curve 3	-100.0 ~ +100.0	%	75.0	●	0x022E
F02.47	Maximum input of curve 3	F02.45 ~ 10.00	V	9.90	●	0x022F
F02.48	Maximum input setting of curve 3	-100.0 ~ +100.0	%	100.0	●	0x0230
F02.49	Minimum input of curve 4	-10.00 ~ F02.51	V	-9.90	●	0x0231
F02.50	Minimum input setting of curve 4	-100.0 ~ +100.0	%	-100.0	●	0x0232
F02.51	Input of	F02.49 ~ F02.53	V	-5.00	●	0x0233

	inflection point 1 of curve 4					
F02.52	Input setting of inflection point 1 of curve 4	-100.0 ~ +100.0	%	-50.0	●	0x0234
F02.53	Input of inflection point 2 of curve 4	F02.51 ~ F02.55	V	5.00	●	0x0235
F02.54	Input setting of inflection point 2 of curve 4	-100.0 ~ +100.0	%	50.0	●	0x0236
F02.55	Maximum input of curve 4	F02.53 ~ 10.00	V	9.90	●	0x0237
F02.56	Maximum input setting of curve 4	-100.0 ~ +100.0	%	100.0	●	0x0238
F02.57	AI1 filtering time	0.00 ~ 10.00	s	0.10	●	0x0239
F02.58	AI2 filtering time	0.00 ~ 10.00	s	0.10	●	0x023A
F02.60	Reserved					0x023C
F02.61	AD hysteresis code	2 ~ 50		2	○	0x023D
F02.62	Selection of analog input AI1 type	0: 0~10V 3: -10~10V 4: 0~5V		0	○	0x023E
F02.63	Selection of analog input AI2 type	0: 0~10V 1: 4~20mA 2: 0~20mA 4: 0~5V		0		0x023F
F02.66	Selection of AI2 current input impedance	0: 500Ω 1: 250Ω		0	○	0x0242
<b>F03</b>	<b>Output terminal function group</b>					
F03.00	Options of Y1 output function	0: no output 1: inverter running (RUN) 2: up to output frequency (FAR)		1	○	0x0300

F03.02	Options of R1 output function (EA-EB-EC)	3: output frequency detection FDT1 4: output frequency detection FDT2 5: reverse running (REV) 6: jog 7: inverter protection 8: inverter ready to run (READY) 9: reach the upper frequency limit 10: reach the lower frequency limit 11: valid current limit 12: valid overvoltage stall 13: complete simple PLC cycle 14: reach the set count value 15: reach the specified count value 16: length reached (in meters) 17: motor overload pre-alarm 18: inverter overheat pre-alarm 19: reach the upper limit of PID feedback 20: reach the lower limit of PID feedback 21: analog level detection ADT1 22: analog level detection ADT2 24: undervoltage state 26: up to the set time 27: zero-speed running 38: off-load 47: PLC output 67: brake control 68: material cutoff detection output 69: FDT1 lower limit (pulse) 70: FDT2 lower limit (pulse) 71: FDT1 lower limit (pulse, invalid in JOG) 72: FDT2 lower limit (pulse, invalid in JOG) 73: output overcurrent									7	○	0x0302
F03.05	Options of output signal type	D7	D6	D5	D4	D3	D2	D1	D0		0*0	○	0x0305
F03.06	Positive/negative logic of digital output	D7	D6	D5	D4	D3	D2	D1	D0		0*0	○	0x0306
F03.08	Output status	D7	D6	D5	D4	D3	D2	D1	D0		00000	○	0x0308

	control in jog	*	*	*	RE V	FDT 2	FDT 1	FAR	RUN					
		0: valid in jogging 1: invalid in jogging												
F03.09	Y1 valid delay time	0.000~30.000									s	0.000	●	0x0309
F03.10	Y1 invalid delay time	0.000~30.000									s	0.000	●	0x030A
F03.13	R1 valid delay time	0.000~30.000									s	0.000	●	0x030D
F03.14	R1 invalid delay time	0.000~30.000									s	0.000	●	0x030E
F03.17	Single pulse time of Y1 output	0.001~30.000									s	0.250	●	0x0311
F03.19	Single pulse time of R1 output	0.001~30.000									s	0.250	●	0x0313
F03.21	Options of analog output M1	0: running frequency (absolute value) 1: set frequency (absolute value) 2: output torque (absolute value) 3: set torque (absolute value) 4: output current 5: output voltage 6: bus voltage 7: output power 8: AI1 9: AI2 12: high-frequency pulse input (with 100% corresponding to 100.00kHz) 13: communication setting 1 14: count value 15: length value 16: PID output 18: PID feedback 19: PID setting 30: communication setting 2										0	○	0x0315
F03.27	M1 output bias	-100.0~100.0									%	0.0	●	0x031B
F03.28	M1 output gain	-10.000~10.000										1.000	●	0x031C
F03.31	Control logic options of	D7	D6	D5	D4	D3	D2	D1	D0		00 000	●	0x031F	

	PLC output terminal	*	*	*	*	*	R1	*	Y1						
		0: no output 1: output													
F03.34	Selection of analog output M1 type	0: 0~10V 1: 4~20mA 2: 0~20mA										0	○	0x0322	
<b>F04</b>	<b>Start/stop control parameter group</b>														
F04.00	Start-up method	0: direct start 1: start of speed tracking										0	○	0x0400	
F04.01	Start frequency	0.00 ~ 10.00										Hz	0.00	○	0x0401
F04.02	Start frequency hold time	0.00 ~ 60.00, 0.00 is invalid										s	0.00	○	0x0402
F04.03	Starting current of DC braking	0.0~100.0 (100.0 = Rated current of motor)										%	100.0	○	0x0403
F04.04	Starting time of DC braking	0.00~30.00 0.00: invalid										s	0.00	○	0x0404
F04.06	Pre-excitation current	50.0 ~ 500.0 (100.0 = no-load current)										%	100.0	○	0x0406
F04.07	Pre-excitation time	0.00 ~ 10.00										s	0.10	○	0x0407
F04.08	Speed tracking mode	Ones place: tracking start frequency 0: maximum frequency 1: stop frequency 2: power frequency Tens place: selection of search direction 0: search only in command direction 1: search in the opposite direction if the speed cannot be found in the command direction											0	○	0x0408
F04.10	Deceleration time of speed tracking	0.1 ~ 20.0										s	2.0	○	0x040A
F04.11	Speed tracking current	30.0 ~ 150.0 (100.0 = rated current of inverter)										%	50.0	○	0x040B

F04.12	Speed tracking compensation gain	0.00 ~ 10.00		1.00	○	0x040C
F04.14	Acceleration and deceleration mode	0: linear acceleration and deceleration 1: acceleration and deceleration of continuous S curve 2: acceleration and deceleration of intermittent S curve		0	○	0x040E
F04.15	Starting time of S curve in acceleration	0.00~30.00(F15.13=0) 0.0~300.0(F15.13=1) 0~3000(F15.13=2)	s	1.00	●	0x040F
F04.16	Ending time of S curve in acceleration	0.00~30.00(F15.13=0) 0.0~300.0(F15.13=1) 0~3000(F15.13=2)	s	1.00	●	0x0410
F04.17	Starting time of S curve in deceleration	0.00~30.00(F15.13=0) 0.0~300.0(F15.13=1) 0~3000(F15.13=2)	s	1.00	●	0x0411
F04.18	Ending time of S curve in deceleration	0.00~30.00(F15.13=0) 0.0~300.0(F15.13=1) 0~3000(F15.13=2)	s	1.00	●	0x0412
F04.19	Stop mode	0: slow down to stop 1: free stop		0	○	0x0413
F04.20	Starting frequency of DC braking in stop	0.00Hz to maximum frequency F00.16	Hz	0.00	○	0x0414
F04.21	DC braking current in stop	0.0~100.0 (100.0 = Rated current of motor)	%	50.0%	○	0x0415
F04.22	DC braking time in stop	0.00~30.00 0.00: invalid	s	0.00	○	0x0416
F04.23	Demagnetization time for DC braking in stop	0.00 ~ 30.00	s	0.50	○	0x0417
F04.24	Flux braking gain	100~150 (100: no flux braking)		100	○	0x0418
F04.26	Start mode after protection/free	0: start according to F04.00 setting mode 1: start of speed tracking		0	○	0x041A

	stop					
F04.27	Second confirmation of terminal start command	0: Not required for confirmation 1: to be confirmed 2: Not required for confirmation of mode start command 2(also not required during fault reset)		0	○	0x041B
F04.28	Lowest effective output frequency	0.00~50.00 (0.00: function invalid)	Hz	0.00	○	0x041C
F04.29	Zero speed check frequency	0.00 ~ 5.00	Hz	0.25	●	0x041D
F04.30	Initial magnetic pole search mode of synchronous motor	0: Invalid 1: Mode 1		0	●	0x041E
<b>F05</b>	<b>V/F control parameter group</b>					
F05.00	V/F curve setting	0: straight line V/F 1: multi-point broken line V/F 2: 1.3-power V/F 3: 1.7-power V/F 4: square V/F 5: vf complete separation mode ( $U_d = 0, U_q = K * t = \text{voltage of separation voltage source}$ ) 6: vf semi-separation mode ( $U_d = 0, U_q = K * t = F/Fe * 2 * \text{voltage of separation voltage source}$ )		0	○	0x0500
F05.01	Frequency point F1 of multi-point VF	0.00 ~ F05.03	Hz	0.50	●	0x0501
F05.02	Voltage point V1 of multi-point VF	0.0~100.0 (100.0 = Rated voltage)	%	1.0	●	0x0502
F05.03	Frequency point F2 of multi-point VF	F05.01~F05.05	Hz	2.00	●	0x0503



F05.04	Voltage point V2 of multi-point VF	0.0~100.0	%	4.0	●	0x0504
F05.05	Frequency point F3 of multi-point VF	F05.03 to rated frequency of motor (reference frequency)	Hz	5.00	●	0x0505
F05.06	Voltage point V3 of multi-point VF	0.0~100.0	%	10.0	●	0x0506
F05.07	Voltage source of VF separation mode	0: digital setting of VF separation voltage 1: AI1 2: AI2 4: high-frequency pulse (X5) 5: PID 6: communication setting note: 100% is the rated voltage of the motor.		0	○	0x0507
F05.08	Digital setting of VF separation voltage	0.0~100.0 (100.0 = rated voltage of motor)	%	0.0	●	0x0508
F05.09	Rise time of VF separation voltage	0.00 ~ 60.00	s	2.00	●	0x0509
F05.10	Compensation gain of V/F stator voltage drop	0.00 ~ 200.00	%	100.0 0	●	0x050A
F05.11	V/F slip compensation gain	0.00 ~ 200.00	%	100.0 0	●	0x050B
F05.12	V/F slip filtering time	0.00 ~ 10.00	s	1.00	●	0x050C
F05.13	Oscillation suppression gain	0 ~ 10000		100	●	0x050D
F05.14	Oscillation suppression cutoff frequency	0.00~600.00	Hz	55.00	●	0x050E
F05.15	Droop control frequency	0.00 ~ 10.00	Hz	0.00	●	0x050F

F05.16	Energy saving rate	0.00 ~ 50.00	%	0.00	●	0x0510
F05.17	Energy saving action time	1.00 ~ 60.00	s	5.00	●	0x0511
F05.18	Flux compensation gain of synchronous motor	0.00 ~ 500.00	%	0.00	●	0x0512
F05.19	Filtering time constant of flux compensation of synchronous motor	0.00 ~ 10.00	s	0.50	●	0x0513
F05.20	Change rate of VF separate power supply setting	-500.0 ~ +500.0	%	0.0	●	0x0514
F06	<b>Vector control parameter group</b>					
F06.00	Speed proportional gain ASR_P1	0.00 ~ 100.00		12.00	●	0x0600
F06.01	Speed integral time constant ASR_T1	0.000-30.000 0.000: no integral	s	0.200	●	0x0601
F06.02	Speed proportional gain ASR_P2	0.00 ~ 100.00		8.00	●	0x0602
F06.03	Speed integral time constant ASR_T2	0.000-30.000 0.000: no integral	s	0.300	●	0x0603
F06.04	Switching frequency 1	0.00 to switching frequency 2	Hz	5.00	●	0x0604
F06.05	Switching frequency 2	Switching frequency 1 to maximum frequency F00.16	Hz	10.00	●	0x0605

F06.06	No-load current gain	50.0~300.0	%	100.0	●	0x0606
F06.07	Filtering time constant of speed loop output	0.000 ~ 0.100	s	0.001	●	0x0607
F06.08	Vector control slip gain	50.00 ~ 200.00	%	100.0 0	●	0x0608
F06.09	Upper limit source selection of speed control torque	0: set by F06.10 and F06.11 1: AI1 2: AI2 3: reserved 4: reserved 5: communication setting (percentage) 6: The larger of AI1 and AI2 7: The smaller of AI1 and AI2		0	○	0x0609
F06.10	Upper limit of speed control motor torque	0.0 ~ 250.0	%	165.0	●	0x060A
F06.11	Upper limit of speed control brake torque	0.0 ~ 250.0	%	165.0	●	0x060B
F06.12	Excitation current proportional gain ACR-P1	0.00 ~ 100.00		0.50	●	0x060C
F06.13	Excitation current integral time constant ACR-T1	0.00-600.00 0.00: no integral	ms	10.00	●	0x060D
F06.14	Torque current proportional gain ACR-P2	0.00 ~ 100.00		0.50	●	0x060E
F06.15	Torque current integral time constant ACR-T2	0.00 ~ 600.00 0.00: no integral	ms	10.00	●	0x060F

F06.17	SVC zero-frequency processing	0: braking 1: not processed 2: seal the tube		2	○	0x0611
F06.18	SVC zero-frequency braking current	50.0 ~ 400.0 (100.0 is the no-load current of the motor)	%	100.0	○	0x0612
F06.20	Voltage feedforward gain	0 ~ 100	%	0	●	0x0614
F06.21	Flux weakening control options	0: invalid 1: direct calculation 2: automatic adjustment		2	○	0x0615
F06.22	Flux weakening voltage	70.00 ~ 100.00	%	95.00	●	0x0616
F06.23	Maximum field weakening current of synchronous motor	0.0 ~ 150.0 (100.0 is the rated current of the motor)	%	100.0	●	0x0617
F06.24	Proportional gain of flux weakening regulator	0.00 ~ 10.00		0.50	●	0x0618
F06.25	Integral time of flux weakening regulator	0.01 ~ 60.00	s	2.00	●	0x0619
F06.26	MTPA control option of synchronous motor	0: invalid 1: valid		1	○	0x061A
F06.27	Self-learning gain at initial position	0 ~ 200	%	100	●	0x061B
F06.28	Frequency of low frequency band of injection current	0.00 ~ 100.00 (100.00 is the rated frequency of the motor)	%	10.00	●	0x061C

F06.29	Injection current of low frequency band	0.0 ~ 60.0 (100.0 is the rated current of the motor)	%	20.0 40.0-( F16.0 0=2)	●	0x061D
F06.30	Regulator gain of low frequency band of injection current	0.00 ~ 10.00		0.50	●	0x061E
F06.31	Regulator integral time of low frequency band of injection current	0.00 ~ 300.00	ms	10.00	●	0x061F
F06.32	Frequency of high frequency band of injection current	0.00 ~ 100.00 (100.00 is the rated frequency of the motor)	%	20.00	●	0x0620
F06.33	Injection current of high frequency band	0.0 ~ 30.0 (100.0 is the rated current of the motor)	%	8.0	●	0x0621
F06.34	Regulator gain of high frequency band of injection current	0.00 ~ 10.00		0.50	●	0x0622
F06.35	Regulator integral time of high frequency band of injection current	0.00 ~ 300.00	ms	10.00	●	0x0623
F06.36	Magnetic saturation coefficient of synchronous	0.00~1.00		0.75	○	0x0624

	motor					
F06.37	Stiffness coefficient of speed loop	0~20		12	●	0x0625
F06.38	Gain coefficient of sliding mode of synchronous motor	1.00~3.70		3.50	○	0x0626
F06.39	Error width of sliding mode of synchronous motor	0.005~0.100		0.100	○	0x0627
F06.40	Amplitude of injected reactive current of synchronous motor	0.0~20.0	%	10.0	○	0x0628
F06.41	Open-loop low-frequency processing of synchronous motor	0: VF 1: IF 2: IF in start and VF in stop		0	○	0x0629
F06.42	Open-loop low-frequency processing range of synchronous motor	0.0 ~ 50.0	%	8.0	○	0x062A
F06.43	IF injection current	0.0 ~ 600.0	%	50.0	○	0x062B
F06.44	Time constant of pull-in current of magnetic pole	0.0 ~ 6000.0	ms	1.0	○	0x062C
F06.45	Initial lead angle of magnetic pole	0.0 ~ 359.9	°	30.0	○	0x062D

F06.46	Speed tracking proportional gain of synchronous motor	0.00 ~ 10.00		1.00	○	0x062E
F06.47	Speed tracking integral gain of synchronous motor	0.00 ~ 10.00		1.00	○	0x062F
F06.48	Filtering time constant of speed tracking of synchronous motor	0.00 ~ 10.00	ms	0.40	○	0x0630
F06.49	Speed tracking control intensity of synchronous motor	1.0 ~ 100.0		5.0	○	0x0631
F06.50	Speed tracking control threshold of synchronous motor	0.00 ~ 10.00		0.20	○	0x0632
F06.51	Rise time of injected active current of synchronous motor	0.010 ~ 1.000	s	0.020	○	0x0633
F06.76	Low-speed correction factor of stator resistor of asynchronous motor	10.0~500.0	%	100.0	●	0x064C
F06.77	Low speed correction factor of rotor resistor of asynchronous motor	10.0~500.0	%	100.0	●	0x064D

F06.78	Slip gain switching frequency of asynchronous motor	0.10 ~ Fmax								Hz	5.00	○	0x064D
F06.82	Udc filtering time constant	0~1500.0								ms	2.0	●	0x0652
<b>F07</b>	<b>Protection function setting group</b>												
F07.00	Protection shield	E20	*	E13	E06	*	E04	E07	E08	0*0 0*000	○	0x0700	
		0: valid protection 1: shielded protection											
F07.01	Motor overload protection gain	0.20 ~ 10.00									1.00	●	0x0701
F07.02	Motor overload pre-alarm coefficient	50 ~ 100								%	80	●	0x0702
F07.06	Bus voltage control options	Ones place: instantaneous stop/no-stop function options 0: invalid 1: deceleration 2: deceleration to stop Tens place: overvoltage stall function options 0: invalid 1: valid									10	○	0x0706
F07.07	Voltage of overvoltage stall control	110.0 ~ 150.0 (380V, 100.0=537V)								%	131.0 (703V)	○	0x0707
F07.08	Instantaneous stop/no-stop operating voltage	60.0 to instantaneous stop/no-stop recovery voltage (100.0 = standard bus voltage)								%	76.0	○	0x0708
F07.09	Instantaneous stop/no-stop recovery voltage	instantaneous stop/no-stop operating voltage to 100.0								%	86.0	●	0x0709



F07.10	Check time for instantaneous stop/no-stop recovery voltage	0.00 ~ 100.00								s	0.50	●	0x070A
F07.11	Current limit control	0: invalid 1: limit mode 1 2: limit mode 2									2	○	0x070B
F07.12	Current limit level	20.0-180.0(100.0 = the rated current of inverter)								%	150.0	●	0x070C
F07.13	Quick current limit options	0: invalid 1: valid									0	○	0x070D
F07.14	Protection retries	0-20; 0: Disable protection retry									0	○	0x070E
F07.15	Options of digital output action in protection retries	0: no action 1: action									0	○	0x070F
F07.16	Interval of protection retries	0.01 ~ 30.00								s	0.50	●	0x0710
F07.17	Restoration time of protection retries	0.01 ~ 30.00								s	10.00	●	0x0711
F07.18	Action option of protection	E08	*	E07	*	E02	E06	E05	E04	0 *0 *0000	○	0x0712	
		0: allow protection retry 1: disable protection retry											
F07.19	Action option 1 of protection	E21	E16	E15	E14	E13	*	E08	E07	000 00*00	○	0x0713	
		0: free stop 1: stop according to stop mode											
F07.20	Action option 2 of protection	E28		E27		*		E23		00*0	○	0x0714	
		0: free stop 1: stop according to stop mode											

F07.21	Options of load loss protection	0: invalid 1: valid							0	●	0x0715	
F07.22	Load loss detection level	0.0 ~ 100.0						%	20.0	●	0x0716	
F07.23	Load loss detection time	0.0 ~ 60.0						s	1.0	●	0x0717	
F07.24	Options of load loss protection action	0: trip protection, free stop 1: trip protection, stop according to stop mode 2: continue to run, with DO status output							1	○	0x0718	
F07.25	Motor overspeed detection level	0.0 ~ 50.0 (reference: maximum frequency F00.16)						%	20.0	●	0x0719	
F07.26	Motor overspeed detection time	0.0 ~ 60.0, 0.0: disable motor overspeed protection						s	1.0	●	0x071A	
F07.27	AVR function	0: invalid 1: valid 2: automatic							1	○	0x071B	
F07.28	Stall protection detection time	0.0~6000.0(0.0: no stall protection detection)						s	0.0	○	0x071C	
F07.29	Stall control intensity	0 ~ 100						%	20	○	0x071D	
F07.30	Instantaneous stop/no-stop deceleration time	0.00 ~ 300.00						s	20.00	○	0x071E	
F07.32	Action option 2 of protection	E10	E13	E15	E16	*	E19	E20	*	000 00000	○	0x0720
		0: allow protection retry 1: disable protection retry										
F07.36	Action option 3 of protection	*	*	*	*	*	*	E09	E17	**** *00	○	0x0724
		0: allow protection retry 1: disable protection retry										
F07.37	Save the initial voltage during	60.0~100.0						%	76.0	○	0x0725	

	power-off					
F07.38	Power-on read and judge the voltage	60.0~100.0	%	86.0	○	0x0726
F07.39	Power-on read judgment delay time	0~100.00	S	5.00	○	0x0727
F07.40	Steady-state undervoltage judgment delay time	5~6000	ms	20	○	0x0728
F07.42	Short-circuit the ground to judge the setting value of the current	0.0~100.0	%	20	○	0x072A
<b>F08</b>	<b>Multi-segment speed and simple PLC</b>					
F08.00	Multi-segment speed 1	0.00 to maximum frequency F00.16	Hz	0.00	●	0x0800
F08.01	Multi-segment speed 2	0.00 to maximum frequency F00.16	Hz	5.00	●	0x0801
F08.02	Multi-segment speed 3	0.00 to maximum frequency F00.16	Hz	10.00	●	0x0802
F08.03	Multi-segment speed 4	0.00 to maximum frequency F00.16	Hz	15.00	●	0x0803
F08.04	Multi-segment speed 5	0.00 to maximum frequency F00.16	Hz	20.00	●	0x0804
F08.05	Multi-segment speed 6	0.00 to maximum frequency F00.16	Hz	25.00	●	0x0805
F08.06	Multi-segment speed 7	0.00 to maximum frequency F00.16	Hz	30.00	●	0x0806

F08.07	Multi-segment speed 8	0.00 to maximum frequency F00.16	Hz	35.00	●	0x0807
F08.08	Multi-segment speed 9	0.00 to maximum frequency F00.16	Hz	40.00	●	0x0808
F08.09	Multi-speed 10	0.00 to maximum frequency F00.16	Hz	45.00	●	0x0809
F08.10	Multi-segment speed 11	0.00 to maximum frequency F00.16	Hz	50.00	●	0x080A
F08.11	Multi-segment speed 12	0.00 to maximum frequency F00.16	Hz	50.00	●	0x080B
F08.12	Multi-segment speed 13	0.00 to maximum frequency F00.16	Hz	50.00	●	0x080C
F08.13	Multi-segment speed 14	0.00 to maximum frequency F00.16	Hz	50.00	●	0x080D
F08.14	Multi-segment speed 15	0.00 to maximum frequency F00.16	Hz	50.00	●	0x080E
F08.15	Simple PLC running mode	0: stop after a single run 1: stop after a limited number of cycles 2: run at the last segment after a limited number of cycles 3: continuous cycles		0	●	0x080F
F08.16	Limited number of cycles	1 ~ 10000		1	●	0x0810
F08.17	Simple PLC memory options	Ones place: stop memory options 0: no memory (from the first segment) 1: memory (from the moment of stop) Tens place: power-down memory options 0: no memory (from the first segment) 1: memory (from the power-down moment)		0	●	0x0811
F08.18	Simple PLC time unit	0: s (second) 1: min (minute)		0	●	0x0812
F08.19	Setting of the first segment	Ones place: running direction options 0: forward 1: reverse Tens place: acceleration and deceleration time options 0: acceleration and deceleration time 1 1: acceleration and deceleration time 2 2: acceleration and deceleration time 3 3: acceleration and deceleration time 4		0	●	0x0813

F08.20	Running time of the first segment	0.0 ~ 6000.0	s/ min	5.0	●	0x0814
F08.21	Setting of the second segment	Ones place: running direction options 0: forward 1: reverse Tens place: acceleration and deceleration time options 0: acceleration and deceleration time 1 1: acceleration and deceleration time 2 2: acceleration and deceleration time 3 3: acceleration and deceleration time 4		0	●	0x0815
F08.22	Running time of the second segment	0.0 ~ 6000.0	s/ min	5.0	●	0x0816
F08.23	Setting of the third segment	Ones place: running direction options 0: forward 1: reverse Tens place: acceleration and deceleration time options 0: acceleration and deceleration time 1 1: acceleration and deceleration time 2 2: acceleration and deceleration time 3 3: acceleration and deceleration time 4		0	●	0x0817
F08.24	Running time of the third segment	0.0 ~ 6000.0	s/ min	5.0	●	0x0818
F08.25	Setting of the fourth segment	Ones place: running direction options 0: forward 1: reverse Tens place: acceleration and deceleration time options 0: acceleration and deceleration time 1 1: acceleration and deceleration time 2 2: acceleration and deceleration time 3 3: acceleration and deceleration time 4		0	●	0x0819
F08.26	Running time of the fourth segment	0.0 ~ 6000.0	s/ min	5.0	●	0x081A
F08.27	Setting of the fifth segment	Ones place: running direction options 0: forward 1: reverse Tens place: acceleration and deceleration time		0	●	0x081B

		options 0: acceleration and deceleration time 1 1: acceleration and deceleration time 2 2: acceleration and deceleration time 3 3: acceleration and deceleration time 4				
F08.28	Running time of the fifth segment	0.0 ~ 6000.0	s/ min	5.0	●	0x081C
F08.29	Setting of the sixth segment	Ones place: running direction options 0: forward 1: reverse Tens place: acceleration and deceleration time options 0: acceleration and deceleration time 1 1: acceleration and deceleration time 2 2: acceleration and deceleration time 3 3: acceleration and deceleration time 4		0	●	0x081D
F08.30	Running time of the sixth segment	0.0 ~ 6000.0	s/ min	5.0	●	0x081E
F08.31	Setting of the seventh segment	Ones place: running direction options 0: forward 1: reverse Tens place: acceleration and deceleration time options 0: acceleration and deceleration time 1 1: acceleration and deceleration time 2 2: acceleration and deceleration time 3 3: acceleration and deceleration time 4		0	●	0x081F
F08.32	Running time of the seventh segment	0.0 ~ 6000.0	s/ min	5.0	●	0x0820
F08.33	Setting of the eighth segment	Ones place: running direction options 0: forward 1: reverse Tens place: acceleration and deceleration time options 0: acceleration and deceleration time 1 1: acceleration and deceleration time 2 2: acceleration and deceleration time 3 3: acceleration and deceleration time 4		0	●	0x0821
F08.34	Running time of the eighth segment	0.0 ~ 6000.0	s/ min	5.0	●	0x0822

	segment				
F08.35	Setting of the ninth segment	Ones place: running direction options 0: forward 1: reverse Tens place: acceleration and deceleration time options 0: acceleration and deceleration time 1 1: acceleration and deceleration time 2 2: acceleration and deceleration time 3 3: acceleration and deceleration time 4		0	● 0x0823
F08.36	Running time of the ninth segment	0.0 ~ 6000.0	s/ min	5.0	● 0x0824
F08.37	Setting of the tenth segment	Ones place: running direction options 0: forward 1: reverse Tens place: acceleration and deceleration time options 0: acceleration and deceleration time 1 1: acceleration and deceleration time 2 2: acceleration and deceleration time 3 3: acceleration and deceleration time 4		0	● 0x0825
F08.38	Running time of the tenth segment	0.0 ~ 6000.0	s/ min	5.0	● 0x0826
F08.39	Setting of the eleventh segment	Ones place: running direction options 0: forward 1: reverse Tens place: acceleration and deceleration time options 0: acceleration and deceleration time 1 1: acceleration and deceleration time 2 2: acceleration and deceleration time 3 3: acceleration and deceleration time 4		0	● 0x0827
F08.40	Running time of the eleventh segment	0.0 ~ 6000.0	s/ min	5.0	● 0x0828
F08.41	Setting of the twelfth segment	Ones place: running direction options 0: forward 1: reverse Tens place: acceleration and deceleration time options		0	● 0x0829

		0: acceleration and deceleration time 1 1: acceleration and deceleration time 2 2: acceleration and deceleration time 3 3: acceleration and deceleration time 4				
F08.42	Running time of the twelfth segment	0.0 ~ 6000.0	s/ min	5.0	●	0x082A
F08.43	Setting of the thirteenth segment	Ones place: running direction options 0: forward 1: reverse Tens place: acceleration and deceleration time options 0: acceleration and deceleration time 1 1: acceleration and deceleration time 2 2: acceleration and deceleration time 3 3: acceleration and deceleration time 4		0	●	0x082B
F08.44	Running time of the thirteenth segment	0.0 ~ 6000.0	s/ min	5.0	●	0x082C
F08.45	Setting of the fourteenth segment	Ones place: running direction options 0: forward 1: reverse Tens place: acceleration and deceleration time options 0: acceleration and deceleration time 1 1: acceleration and deceleration time 2 2: acceleration and deceleration time 3 3: acceleration and deceleration time 4		0	●	0x082D
F08.46	Running time of the fourteenth segment	0.0 ~ 6000.0	s/ min	5.0	●	0x082E
F08.47	Setting of the fifteenth segment	Ones place: running direction options 0: forward 1: reverse Tens place: acceleration and deceleration time options 0: acceleration and deceleration time 1 1: acceleration and deceleration time 2 2: acceleration and deceleration time 3 3: acceleration and deceleration time 4		0	●	0x082F



F08.48	Running time of the fifteenth segment	0.0 ~ 6000.0	s/ min	5.0	●	0x0830
<b>F09</b>	<b>PID function group</b>					
F09.00	PID setting source	0: digital PID setting 1: AI1 2: AI2 3: reserved 4: reserved 5: PULSE, high-frequency pulse (X5) 6: communication setting		0	○	0x0900
F09.01	Digital PID setting	0.0 to PID setting feedback range F09.03		0.0	●	0x0901
F09.02	PID feedback source	1: AI1 2: AI2 3: reserved 4: reserved 5: PULSE, high-frequency pulse (X5) 6: communication setting		1	○	0x0902
F09.03	PID setting feedback range	0.1 ~ 6000.0		100.0	●	0x0903
F09.04	PID positive and negative action selection	0: positive 1: negative		0	○	0x0904
F09.05	Proportional gain 1	0.00 ~ 100.00		0.40	●	0x0905
F09.06	Integral time 1	0.000 ~ 30.000, 0.000: no integral	s	2.000	●	0x0906
F09.07	Differential time 1	0.000 ~ 30.000	ms	0.000	●	0x0907
F09.08	Proportional gain 2	0.00 ~ 100.00		0.40	●	0x0908
F09.09	Integral time 2	0.000 ~ 30.000, 0.000: no integral	s	2.000	●	0x0909
F09.10	Differential time 2	0.000 ~ 30.000	ms	0.000	●	0x090A
F09.11	PID parameter switching	0: no switching 1: switching via digital input terminal		0	●	0x090B

	conditions	2: automatic switching according to deviation 3: automatic switching by frequency				
F09.12	PID parameter switching deviation 1	0.00 ~ F09.13	%	20.00	●	0x090C
F09.13	PID parameter switching deviation 2	F09.12 ~ 100.00	%	80.00	●	0x090D
F09.14	Initial PID value	0.00~100.00	%	0.00	●	0x090E
F09.15	PID initial value holding time	0.00~650.00	s	0.00	●	0x090F
F09.16	Upper limit of PID output	F9.17~+100.0	%	100.0	●	0x0910
F09.17	Lower limit of PID output	-100.0~F9.16	%	0.0	●	0x0911
F09.18	PID deviation limit	0.00~100.00 (0.00: invalid)	%	0.00	●	0x0912
F09.19	PID differential limit	0.00~100.00	%	5.00	●	0x0913
F09.20	PID integral separation threshold	0.00~100.00 (100.00% = invalid integral separation)	%	100.0 0	●	0x0914
F09.21	PID setting change time	0.000~30.000	s	0.000	●	0x0915
F09.22	PID feedback filtering time	0.000~30.000	s	0.000	●	0x0916
F09.23	PID output filtering time	0.000~30.000	s	0.000	●	0x0917
F09.24	Upper limit detection value of PID feedback disconnection	0.00~100.00; 100.00 = invalid feedback disconnection	%	100.0 0	●	0x0918
F09.25	Lower limit detection value of PID feedback disconnection	0.00~100.00; 0.00 = invalid feedback disconnection	%	0.00	●	0x0919

F09.26	Detection time of PID feedback disconnection	0.000 ~ 30.000	s	0.000	●	0x091A
F09.27	PID sleep control options	0: invalid 1: sleep at zero speed 2: sleep at lower frequency limit 3: sleep with tube sealed		0	●	0x091B
F09.28	Sleep action point	0.00-100.00 (100.00 corresponds to the PID setting feedback range)	%	100.0 0	●	0x091C
F09.29	Sleep delay time	0.0 ~ 6500.0	s	0.0	●	0x091D
F09.30	Wake-up action point	0.00 ~100.00 (100.00 corresponds to the PID setting feedback range)	%	0.00	●	0x091E
F09.31	Wake-up delay time	0.0 ~ 6500.0	s	0.0	●	0x091F
F09.32	Multi-segment PID setting 1	0.0 to PID setting feedback range F09.03		0.0	●	0x0920
F09.33	Multi-segment PID setting 2	0.0 to PID setting feedback range F09.03		0.0	●	0x0921
F09.34	Multi-segment PID setting 3	0.0 to PID setting feedback range F09.03		0.0	●	0x0922
F09.35	Upper limit of feedback voltage	lower limit of feedback voltage to 10.00	V	10.00	●	0x0923
F09.36	Lower limit of feedback voltage	0.00 to upper limit of feedback voltage	V	0.00	●	0x0924
F09.37	Integral action option within set PID change time	0: always calculate the integral term 1: calculate the integral term after the F09.21 set time is reached 2: calculate the integral term when the error is less than F09.38		0 Straight-2	●	0x0925
F09.38	Integral within set PID change time Input deviation	0.00-100.00	%	0	●	0x0926

F09.39	Wake-up option	0: target pressure F09.01 * coefficient of wake-up action point 1: wake-up action point (F09.30)		0	○	0x0927
F09.40	Coefficient of wake-up action point	0.0~100.0 (100% corresponds to PID setting)	%	90.0	●	0x0928
F09.41	Pipeline network alarm overpressure	0.0 to pressure sensor range F09.03	%	90.0	●	0x0929
F09.42	Overpressure protection time	0 ~ 3600 (0: invalid)	s	6	●	0x092A
F09.43	PID reverse limit	0: no limit 1: limit		1	○	0x092B
F09.44	Dormation method selection	0: Follow the frequency of dormancy (F09.45) 1: Follow the dormant movement point to sleep (F09.28)		0	○	0x092C
F09.45	Dormant frequency	0.00 ~ upper limit frequency f00.18	Hz	30.00	●	0x092D
F09.46	Pressure feedback increment	0~100		5	●	0x092E
F09.47	PID regulating dead area	0.00~600.00	Bar	0.02	●	0x092F
<b>F10</b>	<b>Communication function group</b>					
F10.00	Local Modbus communication address	1-247; 0: broadcast address		1	○	0x0A00
F10.01	Baud rate of Modbus communication	0:4800 1:9600 2:19200 3:38400 4:57600 5:115200		1	○	0x0A01
F10.02	Modbus data format	0: 1-8-N-1 (1 start bit + 8 data bits + 1 stop bit) 1: 1-8-E-1 (1 start bit + 8 data bits + 1 even parity check bit + 1 stop bit) 2: 1-8-O-1 (1 start bit + 8 data bits + 1 odd parity check bit + 1 stop bit) 3: 1-8-N-2 (1 start bit + 8 data bits + 2 stop bits)		0	○	0x0A02

		4: 1-8-E-2 (1 start bit + 8 data bits + 1 even parity check bit + 2 stop bits) 5: 1-8-O-2 (1 start bit + 8 data bits + 1 odd parity check bit + 2 stop bits)				
F10.03	485 communication timeout	0.0s ~ 60.0s; 0.0: invalid (valid for the master-slave mode)	s	0.0	●	0x0A03
F10.04	Modbus response delay	1 ~ 20	ms	2	●	0x0A04
F10.05	Options of master-slave communication function	0: invalid 1: valid		0	○	0x0A05
F10.06	Master-slave options	0: slave 1: host (Modbus protocol broadcast transmission)		0	○	0x0A06
F10.07	Data sent by host	0: output frequency 1: set frequency 2: output torque 3: set torque 4: PID setting 5: output current		1	○	0x0A07
F10.08	Proportional factor of slave reception	0.00 ~ 10.00 (multiple)		1.00	●	0x0A08
F10.09	Host sending interval	0.000 ~ 30.000	s	0.200	●	0x0A09
F10.10	Communication protocol option	0: Modbus-RTU protocol		0	×	0x0A0A
F10.56	Options of 485 EEPROM writing	0-10: default operation (for commissioning) 11: writing not triggered (available after commissioning)		0	○	0x0A38
F10.57	Enabling of SCI sending timeout resetting	0: invalid resetting 1: valid resetting		1	●	0x0A39
F10.58	Delay time of SCI sending timeout resetting	110 ~ 10000	mS	150	●	0x0A3A

F10.61	SCI response option	0: reply to both read and write commands 1: reply to write commands only 2: no reply to both read and write commands		0	○	0x0A3D
<b>F11</b>	<b>User-selected parameter group</b>					
F11.00	User-selected parameter 1	The displayed content is Uxx.xx, which means that the Fxx.xx function code is selected. When the function code F11.00 is enabled, the keyboard displays U00.00, indicating that the first selected parameter is F00.00.		U 00.00	●	0x0B00
F11.01	User-selected parameter 2			U 00.01	●	0x0B01
F11.02	User-selected parameter 3			U 00.02	●	0x0B02
F11.03	User-selected parameter 4			U 00.03	●	0x0B03
F11.04	User-selected parameter 5			U 00.04	●	0x0B04
F11.05	User-selected parameter 6			U 00.07	●	0x0B05
F11.06	User-selected parameter 7			U 00.14	●	0x0B06
F11.07	User-selected parameter 8			U 00.15	●	0x0B07
F11.08	User-selected parameter 9			U 00.16	●	0x0B08
F11.09	User-selected parameter 10			U 00.18	●	0x0B09
F11.10	User-selected parameter 11			U 00.19	●	0x0B0A
F11.11	User-selected parameter 12			U 00.29	●	0x0B0B
F11.12	User-selected parameter 13			U 02.00	●	0x0B0C
F11.13	User-selected parameter 14			U 02.01	●	0x0B0D
F11.14	User-selected parameter 15			U 02.02	●	0x0B0E
F11.15	User-selected parameter 16			U 03.00	●	0x0B0F

F11.16	User-selected parameter 17			U 03.02	●	0x0B10
F11.17	User-selected parameter 18			U 03.21	●	0x0B11
F11.18	User-selected parameter 19			U 04.00	●	0x0B12
F11.19	User-selected parameter 20			U 04.20	●	0x0B13
F11.20	User-selected parameter 21			U 05.00	●	0x0B14
F11.21	User-selected parameter 22			U 05.03	●	0x0B15
F11.22	User-selected parameter 23			U 05.04	●	0x0B16
F11.23	User-selected parameter 24			U 08.00	●	0x0B17
F11.24	User-selected parameter 25			U 19.00	●	0x0B18
F11.25	User-selected parameter 26			U 19.01	●	0x0B19
F11.26	User-selected parameter 27			U 19.02	●	0x0B1A
F11.27	User-selected parameter 28			U 19.03	●	0x0B1B
F11.28	User-selected parameter 29			U 19.04	●	0x0B1C
F11.29	User-selected parameter 30			U 19.05	●	0x0B1D
F11.30	User-selected parameter 31			U 19.06	●	0x0B1E
<b>F12</b>	<b>Keyboard and display function group</b>					
F12.00	Reserved			1	○	0x0C00
F12.01	Options of stop function of STOP key	0: valid only in keyboard control 1: with all command channels valid		1	○	0x0C01

F12.02	Parameter locking	0: do not lock 1: reference input not locked 2: all locked, except for this function code		0	●	0x0C02
F12.03	Parameter copying	0: no operation 1: parameter upload to keyboard 2: download parameters to inverter(F01 and F14 groups do not download) 3: download parameters to inverter		0	○	0x0C03
F12.09	Load speed display coefficient	0.01~600.00		30.00	●	0x0C09
F12.10	UP/DOWN acceleration and deceleration rate	0.00: automatic rate 0.05~500.00Hz/s		5.00H z/s	○	0x0C0A
F12.11	Options of UP/DOWN offset clearing	0: not clear (clear changes in main frequency setting) 1: clear in non-running state 2: clear by releasing the UP/DOWN button 3: clear once in non-running state		0	○	0x0C0B
F12.12	Options of UP/DOWN power-down saving of offset	0: do not save 1: save (valid after the offset is modified)		1	○	0x0C0C
F12.13	Power meter resetting	0: do not clear 1: clear		0	●	0x0C0D
F12.14	Restoration of factory defaults	0: no operation 1: restoration of factory defaults (excluding the motor parameters, inverter parameters, manufacturer parameters, running and power-on time record)		0	○	0x0C0E
F12.15	Cumulative power-on time (h)	0~65535	h	XXX	×	0x0C0F
F12.16	Cumulative power-on time (min)	0 ~ 59	min	XXX	×	0x0C10
F12.17	Cumulative running time (h)	0 ~ 65535	h	XXX	×	0x0C11
F12.18	Cumulative running time (min)	0 ~ 59	min	XXX	×	0x0C12



F12.19	Rated power of inverter	0.40 ~ 650.00	kW	Depen ding on the motor type	×	0x0C13
F12.20	Rated voltage of inverter	60 ~ 690	V	Depen ding on the motor type	×	0x0C14
F12.21	Rated current of inverter	0.1 ~ 1500.0	A	Depen ding on the motor type	×	0x0C15
F12.22	Performance software S/N 1	XXX.XX		XXX. XX	×	0x0C16
F12.23	Performance software S/N2	XX.XXX		XX.X XX	×	0x0C17
F12.24	Functional software S/N 1	XXX.XX		XXX. XX	×	0x0C18
F12.25	Functional software S/N 2	XX.XXX		XX.X XX	×	0x0C19
F12.26	Keyboard software serial number 1	XXX.XX		XXX. XX	×	0x0C1A
F12.27	Keyboard software serial number 2	XX.XXX		XX.X XX	×	0x0C1B
F12.28	Serial No. 1	XX.XXX		XX.X XX	×	0x0C1C
F12.29	Serial No. 2	XXXX.X		XXX X.X	×	0x0C1D
F12.30	Serial No. 3	XXXXXX		XXX XX	×	0x0C1E
F12.31	LCD language options	0: Chinese 1: English 2: reserved		0	●	0x0C1F
F12.33	Running status display parameter 1 of Mode 1 (LED stop)	0.00 ~ 99.99		18.00	●	0x0C21

	status display parameter 5)					
F12.34	Running status display parameter 2 of Mode 1 (LED stop status display parameter 1)	0.00 - 99.99		18.01	●	0x0C22
F12.35	Running status display parameter 3 of Mode 1 (LED stop status display parameter 2)	0.00 ~ 99.99		18.06	●	0x0C23
F12.36	Running status display parameter 4 of Mode 1 (LED stop status display parameter 3)	0.00 ~ 99.99		18.08	●	0x0C24
F12.37	Running status display parameter 5 of Mode 1 (LED stop status display parameter 4)	0.00 ~ 99.99		18.09	●	0x0C25
F12.38	LCD large-line display parameter 1	0.00 ~ 99.99		18.00	●	0x0C26
F12.39	LCD large-line display parameter 2	0.00 ~ 99.99		18.06	●	0x0C27
F12.40	LCD large-line display	0.00 ~ 99.99		18.09	●	0x0C28

	parameter 3									
F12.41	Options of UP/DOWN zero crossing	0: invalid 1: valid						0	○	0x0C29
F12.42	Frequency setting of digital potentiometer	0.00 to maximum frequency F00.16					Hz	0.00	×	0x0C2A
F12.43	Digital potentiometer torque setting	0.00- Digital torque setting F13.02					%	0.0	×	0x0C2B
F12.45	UP/DOWN function options of keyboard	Communication	High-speed pulse	Analog quantity	Digital frequency	Multi-segment speed	00000	○	0x0C2C	
		0	0	0	0	0				
		0: invalid 1: valid								
F12.48	Output frequency display	0: absolute value 1: positive/negative						1	●	0x0C30
<b>F13</b>	<b>Torque control parameter group</b>									
F13.00	Speed/torque control options	0: speed control 1: torque control						0	○	0x0D00
F13.01	Options of torque setting source	0: digital torque setting F13.02 1: AI1 2: AI2 3: reserved 4: reserved 5: high frequency pulse input (X5) 6: communication setting 7: reserved 8: digital potentiometer setting (Full range of the items 1-6, corresponding to F13.02 digital torque setting)						0	○	0x0D01
F13.02	Digital torque setting	-200.0 ~ 200.0					%	100.0	●	0x0D02

F13.03	Multi-segment torque 1	-200.0 ~ 200.0	%	0.0	●	0x0D03
F13.04	Multi-segment torque 2	-200.0 ~ 200.0	%	0.0	●	0x0D04
F13.05	Multi-segment torque 3	-200.0 ~ 200.0	%	0.0	●	0x0D05
F13.06	Torque control acceleration and deceleration time	0.00 ~ 120.00	s	0.00	●	0x0D06
F13.08	Upper frequency limit options of torque control	0: set by F13.09 1: AI1 2: AI2 3: reserved 4: reserved 5: high frequency pulse input (X5) 6: communication setting (percentage) 7: communication setting (direct frequency)		0	○	0x0D08
F13.09	Positive upper limit of torque control frequency	0.50 to maximum frequency F00.16	Hz	50.00	●	0x0D09
F13.10	Upper frequency limit offset	0.00 to maximum frequency F00.16	Hz	0.00	●	0x0D0A
F13.11	Static friction torque compensation	0.0 ~ 100.0	%	0.0	●	0x0D0B
F13.12	Frequency range of static friction compensation	0.00 ~ 50.00	Hz	1.00	●	0x0D0C
F13.13	Dynamic friction torque compensation	0.0 ~ 100.0	%	0.0	●	0x0D0D
F13.18	Reverse speed limit options	0 ~ 100	%	100	●	0x0D12
F13.19	Reverse torque control options	0 ~ 1		0	●	0x0D13

F14		Parameter group of motor 2					
F14.00	Motor type	0: ordinary asynchronous motor 1: variable-frequency asynchronous motor 2: permanent magnet synchronous motor			0	○	0x0E00
F14.01	Rated power of electric motor	0.10~650.00		kW	Depen ding on the motor type	○	0x0E01
F14.02	Rated voltage of motor	50~2000		V	Depen ding on the motor type	○	0x0E02
F14.03	Rated current of motor	0.01 to 600.00 rated power of motor: ≤ 75 kW) 0.1 to 6000.0 (rated power of motor: > 75 kW)		A	Depen ding on the motor type	○	0x0E03
F14.04	Rated frequency of motor	0.01~600.00		Hz	Depen ding on the motor type	○	0x0E04
F14.05	Rated speed	1~60000		rpm	Depen ding on the motor type	○	0x0E05
F14.06	Motor winding connection	0:Y 1:Δ			Depen ding on the motor type	○	0x0E06
F14.07	Rated power factor of motor	0.600~1.000			Depen ding on the motor type	○	0x0E07
F14.08	Motor efficiency	30.0~100.0		%	Depen ding on the motor type	○	0x0E08
F14.09	Stator resistance of	1~ 60000 (rated power of motor: ≤ 75 kW) 0.1~ 6000.0 (rated power of motor: > 75kW)		mΩ	Depen ding	○	0x0E09

	asynchronous motor			on the motor type		
F14.10	Rotor resistance of asynchronous motor	1~60000 (rated power of motor: ≤ 75 kW) 0.1~6000.0 (rated power of motor: > 75kW)	mΩ	Depen ding on the motor type	○	0x0E0A
F14.11	Leakage inductance of asynchronous motor	0.01 to 600.00 (rated power of motor: ≤ 75 kW) 0.001 to 60.000 (rated power of motor: > 75 kW)	mH	Depen ding on the motor type	○	0x0E0B
F14.12	Mutual inductance of asynchronous motor	0.1 to 6000.0 (rated power of motor: ≤ 75 kW) 0.01 to 600.00 (rated power of motor: > 75 kW)	mH	Depen ding on the motor type	○	0x0E0C
F14.13	No-load excitation current of asynchronous motor	0.01 to 600.00 (rated power of motor: ≤ 75 kW) 0.1 to 6000.0 (rated power of motor: > 75 kW)	A	Depen ding on the motor type	○	0x0E0D
F14.14	Flux weakening coefficient 1 of asynchronous motor	10.00 ~ 100.00	%	87.00	○	0x0E0E
F14.15	Flux weakening coefficient 2 of asynchronous motor	10.00 ~ 100.00	%	80.00	○	0x0E0F
F14.16	Flux weakening coefficient 3 of asynchronous motor	10.00 ~ 100.00	%	75.00	○	0x0E10
F14.17	Flux weakening coefficient 4 of asynchronous motor	10.00 ~ 100.00	%	72.00	○	0x0E11

F14.18	Flux weakening coefficient 5 of asynchronous motor	10.00 ~ 100.00	%	70.00	○	0x0E12
F14.19	Stator resistance of synchronous motor	1~60000 (rated power of motor: ≤75kW) 0.1 to 6000.0 (rated power of motor: > 75 kW)	mΩ	Depen ding on the motor type	○	0x0E13
F14.20	d-axis inductance of synchronous motor	0.01~600.00 (rated power of motor: ≤ 75 kW) 0.001~60.000 (rated power of motor: > 75kW)	mH	Depen ding on the motor type	○	0x0E14
F14.21	q-axis inductance of synchronous motor	0.01~600.00 (rated power of motor: ≤ 75 kW) 0.001~60.000 (rated power of motor: > 75kW)	mH	Depen ding on the motor type	○	0x0E15
F14.22	Counter electromotive force of synchronous motor	10.0~2000.0 (counter electromotive force of rated speed)	V	Depen ding on the motor type	○	0x0E16
F14.23	Initial electrical angle of synchronous motor	0.0~359.9 (valid for synchronous motor)			○	0x0E17
F14.34	Motor parameter self-learning	00: no operation 01: static self-learning of asynchronous motor 02: rotation self-learning of asynchronous motor 03: inertia self-learning of asynchronous motor 11: static self-learning of synchronous motor 12: rotary self-learning of synchronous motor 13: encoder self-learning of synchronous motor		00	○	0x0E22
F14.35	Drive control mode of motor 2	0: v/f control (VVF) 1: speed sensorless vector control (SVC)		0	○	0x0E23
F14.36	Speed proportional gain ASR P1	0.00~100.00		12.00	●	0x0E24

F14.37	Speed integral time constant ASR T1	0.000~30.000 0.000: no integral	s	0.200	●	0x0E25
F14.38	Speed proportional gain ASR P2	0.00~100.00		8.00	●	0x0E26
F14.39	Speed integral time constant ASR T2	0.000~30.000 0.000: no integral	s	0.300	●	0x0E27
F14.40	Switching frequency 1	0.00 to switching frequency 2	Hz	5.00	●	0x0E28
F14.41	Switching frequency 2	switching frequency 1 to maximum frequency F00.16	Hz	10.00	●	0x0E29
F14.42	No-load current gain of motor 2	50.0~300.0	%	50.0	●	0x0E2A
F14.43	Filtering time constant of speed loop output	0.000 ~ 0.100	s	0.001	●	0x0E2B
F14.44	Vector control slip gain	50.00~200.00	%	100.0 0	●	0x0E2C
F14.45	Upper limit source selection of speed control torque	0: set by F06.10 and F06.11 1: AI1 2: AI2 3: reserved 4: reserved 5: communication setting (percentage) 6: The larger of AI1 and AI2 7: The smaller of AI1 and AI2		0	○	0x0E2D
F14.46	Upper limit of speed control motor torque	0.0 ~ 250.0	%	165.0	●	0x0E2E
F14.47	Upper limit of speed control brake torque	0.0 ~ 250.0	%	165.0	●	0x0E2F
F14.48	Excitation current proportional gain ACR-P1	0.00 ~100.00		0.50	●	0x0E30
F14.49	Excitation current integral time constant	0.00 ~ 600.00 0.00: no integral	ms	10.00	●	0x0E31



	ACR-T1					
F14.50	Torque current proportional gain ACR-P2	0.00 ~ 100.00		0.50	●	0x0E32
F14.51	Torque current integral time constant ACR-T2	0.00 ~ 600.00 0.00: no integral	ms	10.00	●	0x0E33
F14.52	Stiffness coefficient of speed loop of motor 2	0~20		12	●	0x0E34
F14.53	SVC zero-frequency processing	0: braking 1: not processed 2: seal the tube		2	○	0x0E35
F14.54	SVC zero-frequency braking current	50.0 ~ 400.0 (100.0 is the no-load current of the motor)	%	100.0	○	0x0E36
F14.56	Voltage feedforward gain	0 ~ 100	%	0	●	0x0E38
F14.57	Flux weakening control options	0: invalid 1: direct calculation 2: automatic adjustment		2	○	0x0E39
F14.58	Flux weakening voltage	70.00 ~ 100.00	%	95.00	●	0x0E3A
F14.59	Maximum field weakening current of synchronous motor	0.0 ~ 150.0 (100.0 is the rated current of the motor)	%	100.0	●	0x0E3B
F14.60	Proportional gain of flux weakening regulator	0.00 ~ 10.00		0.50	●	0x0E3C
F14.61	Integral time of flux weakening regulator	0.01 ~ 60.00	s	2.00	●	0x0E3D
F14.62	MTPA control option of synchronous	0: invalid 1: valid		0	○	0x0E3E

	motor					
F14.63	Self-learning gain at initial position	0 ~ 200	%	100	●	0x0E3F
F14.64	Frequency of low frequency band of injection current	0.00 ~ 100.00 (100.00 is the rated frequency of the motor)	%	10.00	●	0x0E40
F14.65	Injection current of low frequency band	0.0 ~ 60.0 (100.0 is the rated current of the motor)	%	20.0	●	0x0E41
F14.66	Regulator gain of low frequency band of injection current	0.00 ~ 10.00		0.50	●	0x0E42
F14.67	Regulator integral time of low frequency band of injection current	0.00 ~ 300.00	ms	10.00	●	0x0E43
F14.68	Frequency of high frequency band of injection current	0.00 ~ 100.00 (100.00 is the rated frequency of the motor)	%	20.00	●	0x0E44
F14.69	Injection current of high frequency band	0.0 ~ 30.0 (100.0 is the rated current of the motor)	%	8.0	●	0x0E45
F14.70	Regulator gain of high frequency band of injection current	0.00 ~ 10.00		0.50	●	0x0E46
F14.71	Regulator integral time of high frequency band of	0.00 ~ 300.00	ms	10.00	●	0x0E47

	injection current					
F14.77	Acceleration/deceleration time options of motor 2	0: the same as motor 1 1: acceleration and deceleration time 1 2: acceleration and deceleration time 2 3: acceleration and deceleration time 3 4: acceleration and deceleration time 4		0	○	0x0E4D
F14.78	Maximum frequency of motor 2	20.00 ~ 600.00	Hz	50	○	0x0E4E
F14.79	Upper frequency limit of motor 2	lower limit frequency F00.19 to maximum frequency F14.78	Hz	50	●	0x0E4F
F14.80	V/F curve setting of motor 2	0: straight line V/F 1: multi-point broken line V/F 2: 1.3-power V/F 3: 1.7-power V/F 4: square V/F 5: VF complete separation mode (Ud = 0, Uq = K * t = voltage of separation voltage source) 6: VF semi-separation mode (Ud = 0, Uq = K * t = F/Fe * 2 * voltage of separation voltage source)		0	○	0x0E50
F14.81	Multi-point VF frequency F1 of motor 2	0.00 ~ F14.83	Hz	0.50	●	0x0E51
F14.82	Multi-point VF voltage V1 of motor 2	0.0~100.0 (100.0 = Rated voltage)	%	1.0	●	0x0E52
F14.83	Multi-point VF frequency F2 of motor 2	F14.81 ~ F14.85	Hz	2.00	●	0x0E53
F14.84	Multi-point VF voltage V2 of motor 2	0.0 ~ 100.0	%	4.0	●	0x0E54
F14.85	Multi-point VF frequency F3 of motor 2	F14.83 to rated frequency of motor (reference frequency)	Hz	5.00	●	0x0E55
F14.86	Multi-point VF voltage V3 of motor 2	0.0 ~ 100.0	%	10.0	●	0x0E56
F14.87	Stop mode of motor 2	0: slow down to stop 1: free stop		0	○	0x0E57
F14.96	Low speed correction	10.0 ~ 500.0	%	100.0	●	0x0E60

	factor of stator resistor of asynchronous motor 2					
F14.97	Low speed correction factor of rotor resistor of asynchronous motor 2	10.0 ~ 500.0	%	100.0	●	0x0E61
F14.98	Slip gain switching frequency of asynchronous motor 2	0.10 ~ Fmax	Hz	5.00	○	0x0E62
<b>F15</b>	<b>Auxiliary function group</b>					
F15.00	Jog frequency	0.00 to maximum frequency F00.16	Hz	5.00	●	0x0F00
F15.01	Jog acceleration time	0.00 ~ 650.00 (F15.13=0) 0.0 ~ 6500.0 (F15.13=1) 0 ~ 65000 (F15.13=2)	s	5.00	●	0x0F01
F15.02	Jog deceleration time	0.00 ~ 650.00 (F15.13=0) 0.0 ~ 6500.0 (F15.13=1) 0 ~ 65000 (F15.13=2)	s	5.00	●	0x0F02
F15.03	Acceleration time 2	0.00 ~ 650.00 (F15.13=0) 0.0 ~ 6500.0 (F15.13=1) 0 ~ 65000 (F15.13=2)	s	15.00	●	0x0F03
F15.04	Deceleration time 2	0.00 ~ 650.00 (F15.13=0) 0.0 ~ 6500.0 (F15.13=1) 0 ~ 65000 (F15.13=2)	s	15.00	●	0x0F04
F15.05	Acceleration time 3	0.00 ~ 650.00 (F15.13=0) 0.0 ~ 6500.0 (F15.13=1) 0 ~ 65000 (F15.13=2)	s	15.00	●	0x0F05
F15.06	Deceleration time 3	0.00 ~ 650.00 (F15.13=0) 0.0 ~ 6500.0 (F15.13=1) 0 ~ 65000 (F15.13=2)	s	15.00	●	0x0F06
F15.07	Acceleration time 4	0.00 ~ 650.00 (F15.13=0) 0.0 ~ 6500.0 (F15.13=1) 0 ~ 65000 (F15.13=2)	s	15.00	●	0x0F07
F15.08	Deceleration time 4	0.00 ~ 650.00 (F15.13=0) 0.0 ~ 6500.0 (F15.13=1) 0 ~ 65000 (F15.13=2)	s	15.00	●	0x0F08

F15.09	Fundamental frequency of acceleration and deceleration time	0: maximum frequency F00.16 1: 50.00Hz 2: set frequency		0	○	0x0F09
F15.10	Automatic switching of acceleration and deceleration time	0: invalid 1: valid		0	○	0x0F0A
F15.11	Switching frequency of acceleration time 1 and 2	0.00 to maximum frequency F00.16	Hz	0.00	●	0x0F0B
F15.12	Switching frequency of deceleration time 1 and 2	0.00 to maximum frequency F00.16	Hz	0.00	●	0x0F0C
F15.13	Acceleration and deceleration time unit	0:0.01s 1:0.1s 2:1s		0	○	0x0F0D
F15.14	Frequency hopping point 1	0.00 ~ 600.00	Hz	600.0 0	●	0x0F0E
F15.15	Hopping range 1	0.00 ~ 20.00, 0.00 is invalid	Hz	0.00	●	0x0F0F
F15.16	Frequency hopping point 2	0.00 ~ 600.00	Hz	600.0 0	●	0x0F10
F15.17	Hopping range 2	0.00 ~ 20.00, 0.00 is invalid	Hz	0.00	●	0x0F11
F15.18	Frequency hopping point 3	0.00 ~ 600.00	Hz	600.0 0	●	0x0F12
F15.19	Hopping range 3	0.00 ~ 20.00, 0.00 is invalid	Hz	0.00	●	0x0F13
F15.20	Detection width of output	0.00 ~ 50.00	Hz	2.50	○	0x0F14

	frequency arrival (FAR)					
F15.21	Output frequency detection FDT1	0.00 to maximum frequency F00.16	Hz	30.00	○	0x0F15
F15.22	FDT1 hysteresis	-(Fmax-F15.21)~F15.21	Hz	2.00	○	0x0F16
F15.23	Output frequency detection FDT2	0.00 to maximum frequency F00.16	Hz	20.00	○	0x0F17
F15.24	FDT2 hysteresis	-(Fmax-F15.23)~F15.23	Hz	2.00	○	0x0F18
F15.25	Options of analog level detection ADT	0: AI1 1: AI2		0	○	0x0F19
F15.26	Analog level detection ADT1	0.00 ~ 100.00	%	20.00	●	0x0F1A
F15.27	ADT1 hysteresis	0.00 to F15.26 (valid down in one direction)	%	5.00	●	0x0F1B
F15.28	Analog level detection ADT2	0.00 ~ 100.00	%	50.00	●	0x0F1C
F15.29	ADT2 hysteresis	0.00 to F15.28 (valid down in one direction)	%	5.00	●	0x0F1D
F15.30	Options of energy consumption braking function	0: invalid 1: valid		0	○	0x0F1E
F15.31	Energy consumption braking voltage	110.0 ~ 140.0 (380V, 100.0 = 537V)	%	125.0	○	0x0F1F
F15.32	Braking rate	20 ~ 100 (100 means that duty ratio is 1)	%	100	●	0x0F20
F15.33	Operating mode with set frequency less	0: running at the lower frequency limit 1: shutdown 2: zero-speed running		0	○	0x0F21

	than lower frequency limit					
F15.34	Fan control	<p>Ones place: fan control mode                      0: running after power-on                      1: running at startup                      2: intelligent operation, subject to temperature control</p> <p>Tens place: power on fan control                      0: run for 1 minute and then run in fan control mode                      1: directly operate in fan control mode</p> <p>Hundreds place: Fan low speed mode enable (above 280kW)                      1: the operation at low speed is invalid                      2: low speed operation is valid</p>		101	○	0x0F22
F15.35	Overmodulation intensity	1.00 ~ 1.10		1.05	●	0x0F23
F15.36	Switching options of PWM modulation mode	<p>0: invalid (7-segment PWM modulation)                      1: valid (5-segment PWM modulation)</p>		0	○	0x0F24
F15.37	Switching frequency of PWM modulation mode	0.00 to maximum frequency F00.16	Hz	15.00	●	0x0F25
F15.38	Options of dead zone compensation mode	<p>0: no compensation                      1: compensation mode 1                      2: compensation mode 2</p>		1	○	0x0F26
F15.39	Terminal jog priority	<p>0: invalid                      1: valid</p>		0	○	0x0F27
F15.40	Deceleration time for quick stop	<p>0.00 ~ 650.00 (F15.13=0)                      0.0 ~ 6500.0 (F15.13=1)                      0 ~ 65000 (F15.13=2)</p>	s	1.00	●	0x0F28
F15.55	The current reaches the measured value	0.0~300.0 (100.0% corresponding to rated motor current)	%	100.0	●	0x0F37

F15.56	The current reaches the hysteresis	0.0~F15.44	%	5.0	●	0x0F38
F15.57	Torque reaches test value	0.0~300.0 (100.0% corresponding to rated motor torque)	%	100.0	●	0x0F39
F15.58	The torque reaches the hysteresis ring	0.0~F15.46	%	5.0	●	0x0F3A
F15.62	PG card feedback frequency display filtering time	0~20000	ms	300	●	0x0F3E
F15.63	The speed reaches the limit of rise	0.00~Fmax	Hz	30.00	●	0x0F3F
F15.64	The speed reaches filtering time	0~60000	ms	500	●	0x0F40
F15.65	The speed reaches the limit of descent	0.00~Fmax	Hz	0.00	●	0x0F41
F15.66	Overcurrent detection level	0.1~ 300.0 (0.0: no detection; 100.0%: corresponding to the rated current of motor)	%	200.0	●	0x0F42
F15.67	Overcurrent detection delay time	0.00 ~ 600.00	s	0.00	●	0x0F43
F15.68	Market price	0.00 ~ 100.00		1.00	○	0x0F44
F15.69	Power-frequency load factor	30.0 ~ 200.0	%	90.0	○	0x0F45
<b>F16</b>	<b>Customization function group</b>					
F16.00	Industry application	0: universal model 1: water supply application 2: air compressor application 3: winding application 4: fan application 5: spindle application of machine tool		0	○	0x1000



		6: extruder application 7: high-speed motor application 8: plastic extruding machine 9: EM100 comm macro 10: EM303B comm macro				
F16.01	Set length	1 ~ 65535 (F16.13=0) 0.1 ~ 6553.5 (F16.13=1) 0.01~ 655.35 (F16.13=2) 0.001 ~ 65.535 (F16.13=3)	m	1000	●	0x1001
F16.02	Pulses per meter	0.1 ~ 6553.5		100.0	●	0x1002
F16.03	Set count value	F16.04 ~ 65535		1000	●	0x1003
F16.04	Specified count value	1 ~ F16.03		1000	●	0x1004
F16.05	Set time of regular running	0.0~ 6500.0, 0.0 is invalid	min	0.0	●	0x1005
F16.06	Agent password	0~65535		0	●	0x1006
F16.07	Setting of cumulative power-on arrival time	0-65535; 0: disable the protection when the power-on time is up	h	0	●	0x1007
F16.08	Setting of cumulative running arrival time	0-65535; 0: disable the protection when the running time is up	h	0	●	0x1008
F16.09	Factory password	0~65535		XXX X	●	0x1009
F16.10	Analog output percentage corresponding to the count value 0	0.00 ~100.00	%	0.00	○	0x100A
F16.11	Analog output percentage corresponding to the set count value	0.00 ~100.00	%	100.0 0	○	0x100B

F16.13	Set length resolution	0:1m 1:0.1m 2:0.01 m 3:0.001m									0	○	0x100D
<b>F17</b>	<b>Virtual I/O function group</b>												
F17.00	VX1 virtual input function options	The same as the function options of digital input terminal of F02 group									0	○	0x1100
F17.01	VX2 virtual input function options										0	○	0x1101
F17.02	VX3 virtual input function options										0	○	0x1102
F17.03	VX4 virtual input function options										0	○	0x1103
F17.04	VX5 virtual input function options										0	○	0x1104
F17.05	VX6 virtual input function options										0	○	0x1105
F17.06	VX7 virtual input function options										0	○	0x1106
F17.07	VX8 virtual input function options										0	○	0x1107
F17.08	Virtual input positive/negative logic	D7	D6	D5	D4	D3	D2	D1	D0	00000000	○	0x1108	
		VX8	VX7	VX6	VX5	VX4	VX3	VX2	VX1				
		0: positive logic, valid in the closed state/invalid in the open state 1: negative logic, invalid in the closed state/valid in the open state											
F17.09	VX1-VX8 status setting	D7	D6	D5	D4	D3	D2	D1	D0	00000000	○	0x1109	

	options	VX8	VX7	VX6	VX5	VX4	VX3	VX2	VX1				
		0: the VXn status is the same as VYn output status 1: status set by F17.10											
F17.10	VX1-VX8 status setting	D7	D6	D5	D4	D3	D2	D1	D0		000 00000	●	0x110A
		VX8	VX7	VX6	VX5	VX4	VX3	VX2	VX1				
		0: invalid 1: valid											
F17.11	VX1 valid delay time	0.000~30.000								s	0.000	●	0x110B
F17.12	VX1 invalid delay time	0.000~30.000								s	0.000	●	0x110C
F17.13	VX2 valid delay time	0.000~30.000								s	0.000	●	0x110D
F17.14	VX2 invalid delay time	0.000~30.000								s	0.000	●	0x110E
F17.15	VX3 valid delay time	0.000~30.000								s	0.000	●	0x110F
F17.16	VX3 invalid delay time	0.000~30.000								s	0.000	●	0x1110
F17.17	VX4 valid delay time	0.000~30.000								s	0.000	●	0x1111
F17.18	VX4 invalid delay time	0.000~30.000								s	0.000	●	0x1112
F17.19	VY1 virtual output function options	The same as the function options of digital output terminal of F03 group									0	○	0x1113
F17.20	VY2 virtual output function options										0	○	0x1114
F17.21	VY3 virtual output										0	○	0x1115

	function options												
F17.22	VY4 virtual output function options										0	○	0x1116
F17.23	VY5 virtual output function options										0	○	0x1117
F17.24	Reserved												0x1118
F17.25	Reserved												0x1119
F17.26	Reserved												0x111A
F17.27	Virtual output positive/negative logic	D7	D6	D5	D4	D3	D2	D1	D0	00000	○	0x111B	
		VY8	VY7	VY6	VY5	VY4	VY3	VY2	VY1				
		0: positive logic, valid in the closed state/invalid in the open state 1: negative logic, invalid in the closed state/valid in the open state											
F17.28	Control options of virtual output terminal	D7	D6	D5	D4	D3	D2	D1	D0	11111	○	0x111C	
		VY8	VY7	VY6	VY5	VY4	VY3	VY2	VY1				
		0: depending on the status of terminal X1-X5 (without VY6-8) 1: depending on the output function status											
F17.29	VY1 valid delay time	0.000~30.000								s	0.000	●	0x111D
F17.30	VY1 invalid delay time	0.000~30.000								s	0.000	●	0x111E
F17.31	VY2 valid delay time	0.000~30.000								s	0.000	●	0x111F

F17.32	VY2 invalid delay time	0.000~30.000						s	0.000	●	0x1120	
F17.33	VY3 valid delay time	0.000~30.000						s	0.000	●	0x1121	
F17.34	VY3 invalid delay time	0.000~30.000						s	0.000	●	0x1122	
F17.35	VY4 valid delay time	0.000~30.000						s	0.000	●	0x1123	
F17.36	VY4 invalid delay time	0.000~30.000						s	0.000	●	0x1124	
F17.37	Virtual input terminal status	VX8	VX7	VX6	VX5	VX4	VX3	VX2	VX1	0000000	×	0x1125
		0: invalid 1: valid										
F17.38	Virtual output terminal status	VY8	VY7	VY6	VY5	VY4	VY3	VY2	VY1	00000	×	0x1126
		0: invalid 1: valid										
<b>F18</b>	<b>Monitoring parameter group</b>											
F18.00	Output frequency	0.00 to upper frequency limit						Hz	XXX	×	0x1200	
F18.01	Set frequency	0.00 to maximum frequency F00.16						Hz	XXX	×	0x1201	
F18.03	Estimate feedback frequency	0.00 to upper frequency limit						Hz	XXX	×	0x1203	
F18.04	Output torque	-200.0 ~ 200.0						%	XXX	×	0x1204	
F18.05	Torque setting	-200.0 ~ 200.0						%	XXX	×	0x1205	
F18.06	Output current	0.00 to 650.00 (rated power of motor: ≤ 75 kW)						A	XXX	×	0x1206	
		0.0 to 6500.0 (rated power of motor: > 75 kW)										
F18.07	Output current percentage	0.0~300.0 (100.0 = the rated current of inverter)						%	0	×	0x1207	

F18.08	Output voltage	0.0 ~ 690.0					V	XXX	×	0x1208
F18.09	DC bus voltage	0 ~ 1200					V	XXX	×	0x1209
F18.10	Simple PLC running times	0 ~ 10000						XXX	×	0x120A
F18.11	Simple PLC operation stage	1 ~ 15						XXX	×	0x120B
F18.12	PLC running time at the current stage	0.0 ~ 6000.0						XXX	×	0x120C
F18.14	Load rate	0~65535					rpm	XXX	×	0x120E
F18.15	UP/DOWN offset frequency	0.00 to 2 * Maximum frequency F00.16					Hz	XXX	×	0x120F
F18.16	PID setting	0.0 to PID maximum range						XXX	×	0x1210
F18.17	PID feedback	0.0 to PID maximum range						XXX	×	0x1211
F18.18	Power meter: MWh	0~65535					MWh	XXX	×	0x1212
F18.19	Watt-hour meter: kWh	0.0 ~ 999.9					kWh	XXX	×	0x1213
F18.20	Output power	-650.00~650.00					kW	XXX	×	0x1214
F18.21	Output power factor	-1.000 ~ 1.000						XXX	×	0x1215
F18.22	Digital input terminal status 1	X5	X4	X3	X2	X1		XXX	×	0x1216
		0/1	0/1	0/1	0/1	0/1				
F18.23	Digital input terminal status 2	*	AI2	AI1	*	*		XXX	×	0x1217
		*	0/1	0/1	*	0/1				
F18.25	Output terminal state	*	*	R1	*	Y1		XXX	×	0x1219

		*	*	0/1	*	0/1				
F18.26	AI1	0.0~100.0					%	XXX	×	0x121A
F18.27	AI2	0.0~100.0					%	XXX	×	0x121B
F18.31	High-frequency pulse input frequency: kHz	0.00~100.00					kHz	XXX	×	0x121F
F18.32	High-frequency pulse input frequency: Hz	0~65535					Hz	XXX	×	0x1220
F18.33	Count value	0~65535						XXX	×	0x1221
F18.34	Actual length	0~65535					m	XXX	×	0x1222
F18.35	Remaining time of regular running	0.0 ~ 6500.0					min	XXX	×	0x1223
F18.36	Rotor position of synchronous motor	0.0~359.9°						XXX	×	0x1224
F18.39	VF separation target voltage	0 ~ 690					V	XXX	×	0x1227
F18.40	VF separation output voltage	0 ~ 690					V	XXX	×	0x1228
F18.45	Speed setting	0~65535					rpm	XXX	×	0x12D
F18.46	Output frequency symbol	0~65535						XXX	×	0x122E
F18.51	PID output	-100.0 ~ 100.0					%		×	0x1233
F18.60	Inverter temperature	-40 to 200					°C	0	×	0x123C
F18.67	Saved electric energy (MWH)	cumulative energy saving MWH					0~65535	MWh	×	0x1243

F18.68	Saved electric energy (KWH)	cumulative energy saving KWH	0.0 ~ 999.9	kWh	×	0x1244
F18.69	Saved electric charge (1,000 yuan)	high cumulative cost saving (*1000)	0~ 655.35		×	0x1245
F18.70	Saved electric charge (yuan)	low cumulative cost saving	0.0 ~ 999.9		×	0x1246
F18.71	Power-frequency power consumption MWh	power-frequency power consumption MWh	0~ 655.35	MWh	×	0x1247
F18.72	Power-frequency power consumption KWh	power-frequency power consumption KWh	0.0 ~ 999.9	kWh	×	0x1248
<b>F19</b>	<b>Protection record group</b>					
F19.00	Category of last protection	0: no protection E01: output short circuit protection E02: instantaneous overcurrent E04: steady-state overcurrent E05: overvoltage E06: undervoltage E07: input phase loss E08: output phase loss E09: inverter overload E10: inverter overheat protection E11: parameter setting conflict E13: motor overload E14: external protection E15: inverter memory protection E16: communication abnormality E17: temperature sensor abnormality E18: abnormal disconnection of soft start relay E19: current detection circuit abnormality E20: stall protection E21: PID feedback disconnection E22: reserved E24: parameter identification abnormality		0	×	0x1300



		E25: reserved E26: load loss protection E27: up to the cumulative power-on time E28: up to the cumulative running time E43: material cutoff protection E44: cable protection E57: overpressure in pipeline network E58: under-pressure in pipeline network E76: short-circuit protection to ground				
F19.01	Output frequency in protection	0.00 to upper frequency limit	Hz	0.00	×	0x1301
F19.02	Output current in protection	0.00 to 650.00 (rated power of motor: ≤ 75 kW) 0.0 to 6500.0 (rated power of motor: > 75 kW)	A	0.00	×	0x1302
F19.03	Bus voltage in protection	0 ~ 1200	V	0	×	0x1303
F19.04	Operating status in protection	0: not running 1: forward acceleration 2: reverse acceleration 3: forward deceleration 4: reverse deceleration 5: constant speed in forward running 6: reverse constant speed in reverse running		0	×	0x1304
F19.05	Working time in protection		h	0	×	0x1305
F19.06	Category of previous protection	same as F19.00 parameter description		0	×	0x1306
F19.07	Output frequency in protection		Hz	0.00	×	0x1307
F19.08	Output current in protection		A	0.00	×	0x1308
F19.09	Bus voltage in protection		V	0	×	0x1309
F19.10	Operating status in protection	same as F19.04 parameter description		0	×	0x130A
F19.11	Working time in protection		h	0	×	0x130B

F19.12	Category of two previous protections	same as F19.00 parameter description		0	×	0x130C
F19.13	Output frequency in protection		Hz	0.00	×	0x130D
F19.14	Output current in protection		A	0.00	×	0x130E
F19.15	Bus voltage in protection		V	0	×	0x130F
F19.16	Operating status in protection	same as F19.04 parameter description		0	×	0x1310
F19.17	Working time in protection		h	0	×	0x1311
<b>F27</b>	<b>Winding/unwinding application macro parameter group</b>					
F27.00	Application macro	0: winding mode 1: unwinding mode 2: wire drawing mode 3: straight wire drawing machine mode		0	○	0x1B00
F27.01	Feedforward gain action channel	0: feedforward gain * set source B 1: feedforward gain * set source A 2: feedforward gain * 10V		1	○	0x1B01
F27.02	Feedforward gain input mode	0: no change in feedforward gain 1: 0.00 to upper limit of feedforward gain 2: - upper limit of feedforward gain to + upper limit of feedforward gain		1	○	0x1B02
F27.03	Feedforward control	Ones place: feedforward reset option 0: automatic reset 1: terminal reset Tens place: feedforward power-off stop option 0: save after power failure 1: not save after power failure Hundreds place: options of continuous feedforward calculation 0: not calculate 1: calculate		10	○	0x1B03
F27.04	Upper limit of feedforward gain	0.00~500.00	%	500.0 0	○	0x1B04

F27.05	Initial feedforward gain	0.00~500.00	%	50.00	●	0x1B05
F27.06	Feedforward gain filter time	0~1000	ms	0	●	0x1B06
F27.07	Feedforward range 0	0.00 to feedforward range 1	%	4.00	●	0x1B07
F27.08	Feedforward range 1	feedforward range 0 to feedforward range 2	%	12.00	●	0x1B08
F27.09	Feedforward range 2	feedforward range 1 to feedforward range 3	%	23.00	●	0x1B09
F27.10	Feedforward range 3	feedforward range 2 to feedforward range 4	%	37.00	●	0x1B0A
F27.11	Feedforward range 4	feedforward range 3 to feedforward range 5	%	52.00	●	0x1B0B
F27.12	Feedforward range 5	feedforward range 4 to 100.00	%	72.00	●	0x1B0C
F27.13	Soft start increment	0.00 ~ 50.00	%/S	0.60	●	0x1B0D
F27.14	Feedforward increment 1	0.00 ~ 50.00	%/S	0.11	●	0x1B0E
F27.15	Feedforward increment 2	0.00 ~ 50.00	%/S	0.30	●	0x1B0F
F27.16	Feedforward increment 3	0.00 ~ 50.00	%/S	0.75	●	0x1B10
F27.17	Feedforward increment 4	0.00 ~ 50.00	%/S	1.55	●	0x1B11
F27.18	Feedforward increment 5	0.00 ~ 50.00	%/S	4.00	●	0x1B12
F27.19	Feedforward increment 6	0.00 ~ 50.00	%/S	11.00	●	0x1B13
F27.20	Material cutoff control mode	Ones place: disconnection detection mode 0: automatic detection 1: external signal Tens place: material cutoff detection control 0: detect when the output is greater than the lower limit of material cutoff detection 1: no detection Hundreds place: material cutoff handling mode		01201	○	0x1B14

		0: protection of terminal action only 1: delayed stop and trip protection 2: material cutoff protection 3: automatic reset after protection shutdown 4: material cutoff detection terminal output only (straight wire drawing machine) 5: automatic reset of cutoff detection terminal (straight wire drawing machine) Thousands place: brake mode 0: mode 0 1: mode 1 Myriabit: reverse unwinding mode 0: no speed limit 1: reverse speed limit by F27.24				
F27.21	Material cutoff detection delay	0.0~10.0	S	6.0	●	0x1B15
F27.22	Lower limit of material cutoff detection after parking	0.00 ~ 60.00	Hz	5.00	●	0x1B16
F27.23	Time of continuous running after material cutoff	0.0 ~ 60.0	S	10.0	●	0x1B17
F27.24	Frequency of continuous running after material cutoff	0.00~Fmax	Hz	5.00	●	0x1B18
F27.25	Brake signal output frequency	0.00~FUP	Hz	2.50	●	0x1B19
F27.26	Braking signal duration	0.0~100.0	S	5.0	●	0x1B1A
F27.27	Minimum frequency of wiring detection	0.00~20.00	Hz	10.00	●	0x1B1B
F27.28	Judgment time for invalid cable signal	0.1 ~ 20.0	S	10.0	●	0x1B1C
F27.29	Judgment time for valid cable	0.1 ~ 20.0	S	2.0	●	0x1B1D

	signal					
F27.30	Filtering time for material cutoff detection	1~100	ms	5	●	0x1B1E
F27.36	Current value of feedforward gain	-500.0~500.0	%		×	0x1B24
<b>F45</b>	<b>Modbus free mapping parameter group</b>					
F45.00	Modbus communication mapping	0: invalid 1: valid	-	0	●	0x2D00
F45.01	Source address 1	0~65535	-	0	●	0x2D01
F45.02	Destination address 1	0~65535	-	0	●	0x2D02
F45.03	Mapping coefficient 1	0.00~100.00	-	1.00	●	0x2D03
F45.04	Source address 2	0~65535	-	0	●	0x2D04
F45.05	Destination address 2	0~65535	-	0	●	0x2D05
F45.06	Mapping coefficient 2	0.00~100.00	-	1.00	●	0x2D06
F45.07	Source address 3	0~65535	-	0	●	0x2D07
F45.08	Destination address 3	0~65535	-	0	●	0x2D08
F45.09	Mapping coefficient 3	0.00~100.00	-	1.00	●	0x2D09
F45.10	Source address	0~65535	-	0	●	0x2D0A

	4					
F45.11	Destination address 4	0~65535	-	0	●	0x2D0B
F45.12	Mapping coefficient 4	0.00~100.00	-	1.00	●	0x2D0C
F45.13	Source address 5	0~65535	-	0	●	0x2D0D
F45.14	Destination address 5	0~65535	-	0	●	0x2D0E
F45.15	Mapping coefficient 5	0.00~100.00	-	1.00	●	0x2D0F
F45.16	Source address 6	0~65535	-	0	●	0x2D10
F45.17	Destination address 6	0~65535	-	0	●	0x2D11
F45.18	Mapping coefficient 6	0.00~100.00	-	1.00	●	0x2D12
F45.19	Source address 7	0~65535	-	0	●	0x2D13
F45.20	Destination address 7	0~65535	-	0	●	0x2D14
F45.21	Mapping coefficient 7	0.00~100.00	-	1.00	●	0x2D15
F45.22	Source address 8	0~65535	-	0	●	0x2D16
F45.23	Destination address 8	0~65535	-	0	●	0x2D17
F45.24	Mapping coefficient 8	0.00~100.00	-	1.00	●	0x2D18

F45.25	Source address 9	0~65535	-	0	●	0x2D19
F45.26	Destination address 9	0~65535	-	0	●	0x2D1A
F45.27	Mapping coefficient 9	0.00~100.00	-	1.00	●	0x2D1B
F45.28	Source address 10	0~65535	-	0	●	0x2D1C
F45.29	Destination address 10	0~65535	-	0	●	0x2D1D
F45.30	Mapping coefficient 10	0.00~100.00	-	1.00	●	0x2D1E
F45.31	Source address 11	0~65535	-	0	●	0x2D1F
F45.32	Destination address 11	0~65535	-	0	●	0x2D20
F45.33	Mapping coefficient 11	0.00~100.00	-	1.00	●	0x2D21
F45.34	Source address 12	0~65535	-	0	●	0x2D22
F45.35	Destination address 12	0~65535	-	0	●	0x2D23
F45.36	Mapping coefficient 12	0.00~100.00	-	1.00	●	0x2D24
F45.37	Source address 13	0~65535	-	0	●	0x2D25
F45.38	Destination address 13	0~65535	-	0	●	0x2D26
F45.39	Mapping coefficient 13	0.00~100.00	-	1.00	●	0x2D27

F45.40	Source address 14	0~65535	-	0	●	0x2D28
F45.41	Destination address 14	0~65535	-	0	●	0x2D29
F45.42	Mapping coefficient 14	0.00~100.00	-	1.00	●	0x2D2A
F45.43	Source address 15	0~65535	-	0	●	0x2D2B
F45.44	Destination address 15	0~65535	-	0	●	0x2D2C
F45.45	Mapping coefficient 15	0.00~100.00	-	1.00	●	0x2D2D
F45.46	Source address 16	0~65535	-	0	●	0x2D2E
F45.47	Destination address 16	0~65535	-	0	●	0x2D2F
F45.48	Mapping coefficient 16	0.00~100.00	-	1.00	●	0x2D30
F45.49	Source address 17	0~65535	-	0	●	0x2D31
F45.50	Destination address 17	0~65535	-	0	●	0x2D32
F45.51	Mapping coefficient 17	0.00~100.00	-	1.00	●	0x2D33
F45.52	Source address 18	0~65535	-	0	●	0x2D34
F45.53	Destination address 18	0~65535	-	0	●	0x2D35
F45.54	Mapping coefficient 18	0.00~100.00	-	1.00	●	0x2D36



F45.55	Source address 19	0~65535	-	0	●	0x2D37
F45.56	Destination address 19	0~65535	-	0	●	0x2D38
F45.57	Mapping coefficient 19	0.00~100.00	-	1.00	●	0x2D39
F45.58	Source address 20	0~65535	-	0	●	0x2D3A
F45.59	Destination address 20	0~65535	-	0	●	0x2D3B
F45.60	Mapping coefficient 20	0.00~100.00	-	1.00	●	0x2D3C
F45.61	Source address 21	0~65535	-	0	●	0x2D3D
F45.62	Destination address 21	0~65535	-	0	●	0x2D3E
F45.63	Mapping coefficient 21	0.00~100.00	-	1.00	●	0x2D3F
F45.64	Source address 22	0~65535	-	0	●	0x2D40
F45.65	Destination address 22	0~65535	-	0	●	0x2D41
F45.66	Mapping coefficient 22	0.00~100.00	-	1.00	●	0x2D42
F45.67	Source address 23	0~65535	-	0	●	0x2D43
F45.68	Destination address 23	0~65535	-	0	●	0x2D44
F45.69	Mapping coefficient 23	0.00~100.00	-	1.00	●	0x2D45

F45.70	Source address 24	0~65535	-	0	●	0x2D46
F45.71	Destination address 24	0~65535	-	0	●	0x2D47
F45.72	Mapping coefficient 24	0.00~100.00	-	1.00	●	0x2D48
F45.73	Source address 25	0~65535	-	0	●	0x2D49
F45.74	Destination address 25	0~65535	-	0	●	0x2D4A
F45.75	Mapping coefficient 25	0.00~100.00	-	1.00	●	0x2D4B
F45.76	Source address 26	0~65535	-	0	●	0x2D4C
F45.77	Destination address 26	0~65535	-	0	●	0x2D4D
F45.78	Mapping coefficient 26	0.00~100.00	-	1.00	●	0x2D4E
F45.79	Source address 27	0~65535	-	0	●	0x2D4F
F45.80	Destination address 27	0~65535	-	0	●	0x2D50
F45.81	Mapping coefficient 27	0.00~100.00	-	1.00	●	0x2D51
F45.82	Source address 28	0~65535	-	0	●	0x2D52
F45.83	Destination address 28	0~65535	-	0	●	0x2D53
F45.84	Mapping coefficient 28	0.00~100.00	-	1.00	●	0x2D54

F45.85	Source address 29	0~65535	-	0	●	0x2D55
F45.86	Destination address 29	0~65535	-	0	●	0x2D56
F45.87	Mapping coefficient 29	0.00~100.00	-	1.00	●	0x2D57
F45.88	Source address 30	0~65535	-	0	●	0x2D58
F45.89	Destination address 30	0~65535	-	0	●	0x2D59
F45.90	Mapping coefficient 30	0.00~100.00	-	1.00	●	0x2D5A

## Chapter 7 Function Code Details

### 7.1 Basic Function Parameter Group of F00 Group

Function code	Function code name	Parameter description	Unit	Default setting	Attribute	mailing address
F00.01	Drive control mode of motor 1	0: V/F control (VVF) 1: Speed sensorless vector control (SVC)		0	○	0x0001

#### **F00.01=0: V/F control (VVF)**

It is used for one-to-many, fast and low-precision speed control.

#### **F00.01=1: speed sensorless vector control (SVC)**





The open-loop vector control is suitable for general high-performance control. An inverter drives one motor only. It is suitable for machine tools, centrifuges, drawing machines, injection molding machines and other loads.



1. In order to improve the control performance, self-learning is needed to obtain the correct motor parameters before vector control.
2. In the vector control mode, the inverter can be used with one motor only, and the motor capacity should not be greatly different from the inverter capacity; otherwise, the control performance may decline or the system may not work properly.

Function code	Function code name	Parameter description	Unit	Default setting	Attribute	mailing address
F00.02	Options of command source	F00.02=0: keyboard control (LOC/REM indicator ON) 1: terminal control (LOC/REM indicator: OFF) 2: communication control (LOC/REM indicator: flicker)		0	○	0x0002

#### **F00.02=0: keyboard control (LOC/REM indicator ON)**

The start and stop of the inverter are controlled by the RUN key , STOP key  on the keyboard. In the case of no trip protection, press the RUN key  to enter the running status. If the green LED indicator above the RUN key  is ON, it indicates that the inverter is in the running status. If this indicator is flickering, it means that the inverter is in

the status of deceleration to stop.

Regardless of the speed or torque reference input control, the inverter will run in the input control mode at the jog speed once jogging is enabled.

**F00.02=1: terminal control (LOC/REM indicator OFF)**

The start and stop of the inverter are controlled by the start and stop control terminals that are defined by the function codes F02.00 to F02.06. Detailed settings of terminal control are dependent on F00.03.

**F00.02=2: Communication control (LOC/REM indicator flickering)**

The inverter start and stop are controlled by the host through the RS485 communication port. See the 11.3.4 Register **address distribution** 7000H control description for details.

	<p>The final command source also depends on the input functions “24: switching from the Run command to keyboard” and “25: switching from the Run command to communication”. If the input function “24: switching from the Run command to keyboard” is valid, the current command source is “keyboard control”. If the input function “25: switching from the Run command to communication” is valid, the current command source is “communication control”. Otherwise, the command source depends on the setting of the function code F00.02.</p>
---	---

Function code	Function code name	Parameter description	Unit	Default setting	Attribute	mailing address
F00.03	Options of terminal control mode	0: terminal RUN (running) and F/R (forward/reverse) 1: terminal RUN (forward) and F/R (reverse) 2: terminal RUN (forward), Xi (stop) and F/R (reverse) 3: terminal RUN (running), Xi (stop) and F/R (forward/reverse)		0	○	0x0003

**Terminal RUN:** Xi terminal is set to “1: terminal RUN”

**Terminal F/R:** Xi terminal is set to “2: running direction F/R”

**Terminal control can be divided into two types: two-line control & three-line control.**

**Two-line control:**

F00.03=0: the terminal RUN is in the running status, and F/R in the forward/reverse status.

Enable/Disable the terminal RUN to control the start and stop of the inverter, and the terminal F/R to control the forward/reverse running. If F00.21 is set to 1 and reverse running is disabled, the F/R terminal will not be available. If the mode of deceleration to stop is selected,

the logic diagram is as shown in Fig. 7-6(b);

**F00.03=1: the terminal RUN controls forward running, and the terminal F/R is in the reverse mode.**

Enable/Disable the terminal RUN to control the forward running and stop of the inverter, and the terminal F/R to control the reverse running and stop. When the terminals RUN and F/R are enabled simultaneously, the inverter will be stopped. If reverse running is disabled, the terminal F/R will not be available. If the mode of deceleration to stop is selected, the forward/reverse logic will be run, as shown in Fig. 7-6(d);

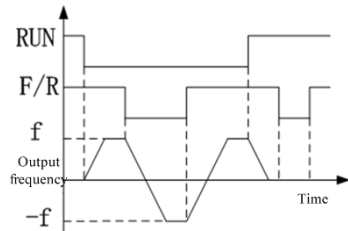
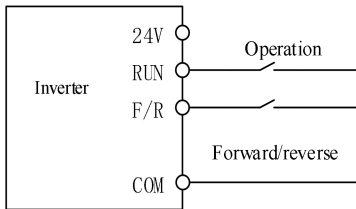

(a) Wiring diagram of two-line control (F00.03=0) (b) F04.19=0, F00.03=0, run the forward/reverse logic

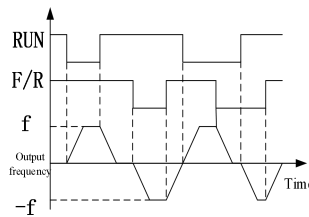
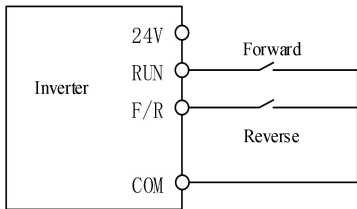

(c) Wiring diagram of two-line control (F00.03=1) (d) F04.19=0, F00.03=1: forward/reverse running logic

Fig. 7-6 Two-line Control

When the start/stop value of F00.03 is set to 0 or 1, even if the terminal RUN is available, the inverter can be stopped by pressing the STOP key  or sending an external stop command to the terminal. In this case, the inverter will not be in the running status until the terminal RUN is disabled and then enabled.

**Three-line control:**

**F00.03=2: the terminal RUN controls forward running, the terminal Xi is for stop, and the terminal F/R is in the reverse status.**

The terminal RUN is normally ON for forward running, and the terminal F/R is normally ON for reverse running, with valid pulse edges. The terminal Xi is normally closed for stop, with the valid level. When the inverter is in the running status, press Xi to stop it. When the mode of deceleration to stop (F04.19=0) is selected, the logic diagram is as shown in Fig. 7-7(b). The terminal Xi is for “three-line running and stop control” as defined by F02.00 to F02.04.

**F00.03=3: the terminal RUN is for running, Xi for stop and F/R for forward/reverse control.**

The terminal RUN is normally ON for running, with the valid pulse edge, F/R for forward/reverse switching (forward in the OFF status and reverse in the ON status), and Xi is normally OFF for stop, with the valid level. When the mode of deceleration to stop (F04.19=0) is selected, the logic diagram is as shown in Fig. 7-7(d).

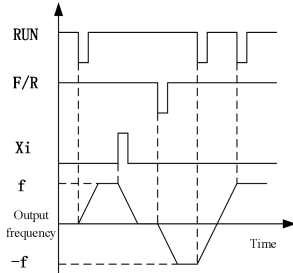
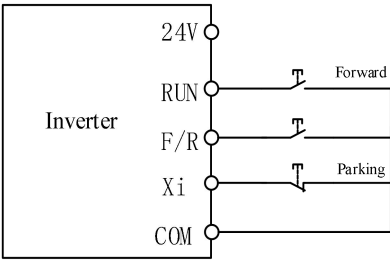

(a) Wiring diagram of three-line control (F00.03=2) (b) F04.19=0, F00.03=2: forward/reverse running logic

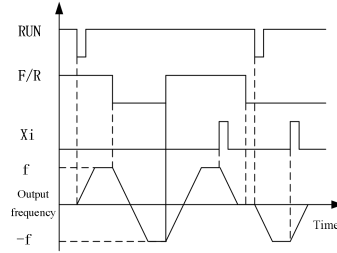
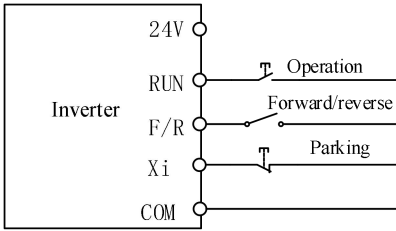

(c) Wiring diagram of three-line control (F00.03=3)

(d) F04.19=0, F00.03=3: forward/reverse running logic

Fig. 7-7 Three-line Control

 The three-line control logic of the EM730 series inverter is consistent with the conventional electrical control. The keys and knob switches should be used correctly as shown in the schematic diagram. Otherwise, operation errors may be caused.

Function code	Function code name	Parameter description	Unit	Default setting	Attribute	mailing address
F00.04	Options of main frequency source A	0: digital frequency setting F00.07 1: AI1 2: AI2 3: reserved 4: reserved 5: high frequency pulse input (X5) 6: percentage setting of main frequency communication 7: direct setting of main frequency communication 8: digital potentiometer setting		8	○	0x0004

**F00.04=0: digital frequency setting F00.07**

The main frequency source A depends on the digital frequency setting F00.07.

**F00.04=1:AI1**

**F00.04=2:AI2**

The main frequency source A depends on the AI (percentage) \* F00.16.

AI1 is the 0-10V voltage input;

AI2 is the 0-10V voltage input or 0-20mA current input, selected via the terminals S4/S5 on the terminal block.

The percentage corresponding to the input physical quantity of the AI terminal is set by the



function codes F02.31 to F02.36. 100.00% is the percentage to the set value of F00.16 (maximum frequency).

**F00.04=5: High-frequency pulse input (X5)**

The main frequency source A depends on the HDI (percentage) \* F00.16.

The terminal X5 can also be used for high-frequency pulse input (set the terminal function F02.04 to “40: pulse input”), with the frequency of 0.00-100.00kHz and voltage of 12-48V. The corresponding percentage of terminal input pulse frequency is set by F02.06-F02.29. 100.00% is the percentage relative to the set value of F00.16 (maximum frequency).

**F00.04=6 or 7: main frequency communication setting**

The main frequency source A depends on the communication, etc.

- If the master-slave communication (F10.05=1) is enabled and the inverter works as the slave (F10.06=0), the main frequency source A is set to “700FH (master-slave communication setting) \* F00.16 (maximum frequency) \* F10.08 (slave receiving proportional coefficient)”, and the 700FH data range is -100.00% to 100.00%, as detailed in Table 12-31.
- For general communication (F10.05=0):

- a、**F00.04=6** percentage setting: the main frequency source A is set to “7001H (communication percentage setting of the main channel frequency A) \* F00.16 (maximum frequency)”;
- b、**F00.04=7** direct frequency setting: the main frequency source A is set to “7015H (communication setting of the main channel frequency A)”

The 7001H data range is -100.00% to 100.00%, and the 7015H data range is 0.00 to F00.16 (maximum frequency), as detailed in Table 12-31.

**F00.04=8: digital potentiometer setting**

In the speed mode, the main frequency source A is set directly by the digital potentiometer, and only the monitoring interface is available. See F12.42 for the specific value.

**Operating instructions for the digital potentiometer:** In the monitoring interface, turn the digital potentiometer clockwise or counterclockwise to increase or decrease the set frequency. This is the editing status, and the value will flash if changed. After the change is made, press the ENTER key to exit the editing status. The indicator will no longer flicker. Or, After the modification is complete, press ESC to return to the One-level menu interface. The previously modified value is still valid. See the running monitoring of keyboard operation.

The final setting of the main frequency source A is also dependent on the DI terminal status:

Table 7-3 Detailed Setting of Main Frequency Source A

Terminal Function	Status Description	Priority
11-14: multi-segment speed terminals 1-4	If one is valid, the multi-segment speed mode will be enabled (F08.00-F08.14).	1
51: switching of main frequency source to digital frequency setting	Valid, depending on the digital frequency setting F00.07, the same as the function code F00.04=0	2
52: switching of main frequency source to AI1	Valid, depending on the AI1 input percentage setting, the same as the function code F00.04=1	3
53: Switching of main frequency source to AI2	Valid, depending on the AI2 input percentage setting, the same as the function code F00.04=2	4
56: switching of main frequency source to communication setting	Valid, depending on the communication input, the same as the function code F00.04=6	7
--	All invalid, depending on the setting of function code F00.04	8

**F00.05=0: digital frequency setting F00.07**

Function code	Function code name	Parameter description	Unit	Default setting	Attribute	mailing address
F00.05	Options of auxiliary frequency source B	0: digital frequency setting F00.07 1: AI1 2: AI2 3: reserved 4: reserved 5: high frequency pulse input (X5) 6: percent setting of auxiliary frequency communication 7: direct setting of auxiliary frequency communication 8: digital potentiometer setting 9: reserved 10: process PID 11: simple PLC		0	○	0x0005

The auxiliary frequency B depends on the digital frequency setting F00.07.

**F00.05=1:AI1**

**F00.05=2:AI2**

The auxiliary frequency B is determined by AI (percentage) \* F00.16.

For the details of AI1 and AI2, refer to the F00.04 description. They have the same meaning. 100.00% is the percentage to the set value of F00.16 (maximum frequency).

**F00.05=5: High-frequency pulse input (X5)**

The auxiliary frequency B is determined by HDI (percentage) \* F00.16.

For the details of AI1-AI2 and X5, refer to the F00.04 description. They have the same meaning. 100.00% is the percentage to the set value of F00.16 (maximum frequency).

**F00.05=6 or 7: auxiliary frequency communication setting**

The auxiliary frequency B depends on the communication and others.

- If the master-slave communication (F10.05=1) is enabled and the inverter works as the slave (F10.06=0), the auxiliary frequency B is set to “700FH (master-slave communication setting) \* F00.16 (maximum frequency) \* F10.08 (slave receiving proportional coefficient)”, and the 700FH data range is -100.00% to 100.00%, as detailed in Table 12-31.

- For general communication (F10.05=0):

- a. **F00.05=6**, the auxiliary frequency B is set to “7002H (communication setting of the auxiliary channel frequency B) \* F00.16 (maximum frequency)”;
- b. **F00.05=7**, the auxiliary frequency B is set to “7016H (communication setting of the auxiliary channel frequency B)”.

The 7002H data range is -100.00% to 100.00%, and the 7002H data range is 0.00 to F00.16 (maximum frequency), as detailed in Table 12-31.

**F00.05=8: digital potentiometer setting**

In the speed mode, the auxiliary frequency B is set directly by the digital potentiometer. See the F00.04 description for details.

**F00.05=10: process PID**

The auxiliary frequency B depends on the process PID function output, as detailed in 7.10. This is usually applied in on-site closed-loop process control, such as the constant-pressure closed-loop control and constant-tension closed-loop control.

**F00.05=11: Simple PLC**

The auxiliary frequency B depends on the simple PLC function output, as detailed in the

multi-segment group (F08) and simple PLC parameter group.



The same physical channel (AI1 or AI2) cannot be selected for the main frequency source A and auxiliary frequency source B;

The process PID and simple PLC modules will not be valid until they are selected.

Function code	Function code name	Parameter description	Unit	Default setting	Attribute	mailing address
F00.06	Options of frequency source	0: main frequency source A 1: auxiliary frequency source B 2: main and auxiliary operation results 3: switching between main frequency source A and auxiliary frequency source B 4: switching between main frequency source A and main and auxiliary operation results 5: switching between auxiliary frequency source B and main and auxiliary operation results		0	○	0x0006

Select the final valid frequency setting channel and operation mode.

**F00.06=0: main frequency source A**

The final set frequency only depends on the main frequency source A.

**F00.06=1: auxiliary frequency source B**

The final set frequency only depends on the auxiliary frequency source B.

**F00.06=2: main and auxiliary operation results**

The final set frequency depends on the main and auxiliary operation results. Refer to the description of the function code F00.08.

**F00.06=3: switching between the main frequency source A and auxiliary frequency source B**

The final set frequency is determined by the status of the input function “26: Frequency source switching”: invalid, depending on the main frequency source A; valid, depending on the auxiliary frequency source B.

**F00.06=4: switching between main frequency source A and main and auxiliary calculation results**

The final set frequency is determined by the status of the input function “26: Frequency source switching”: invalid, depending on the main frequency source A; valid, depending on the main and auxiliary operation results. Refer to the description of the function code F00.08.

**F00.06=5: switching between the auxiliary frequency source B and main and auxiliary operation results**

The final set frequency is determined by the status of the input function “26: Frequency source switching”: invalid, depending on the auxiliary frequency source B; valid, depending on the main and auxiliary operation results. Refer to the description of the function code F00.08.

Function code	Function code name	Parameter description	Unit	Default setting	Attribute	mailing address
F00.07	Digital frequency setting	0.00 to maximum frequency	Hz	50.00	●	0x0007

F00.07 is used to set the digital frequency, and its maximum value is limited by the maximum frequency (F00.16).

Function code	Function code name	Parameter description	Unit	Default setting	Attribute	mailing address
F00.08	Options of main and auxiliary operation	0: main frequency source A + auxiliary frequency source B 1: main frequency source A - auxiliary frequency source B 2: larger value of main and auxiliary frequency sources 3: smaller value of main and auxiliary frequency sources		0	○	0x0008

Select the main and auxiliary operation mode. The final results are limited by the lower frequency limit (F00.19) and upper frequency limit (F00.18).

**F00.08=0: main frequency source A + auxiliary frequency source B**

The main and auxiliary operation result is the sum of the two items, and may be positive or negative. That is, the result of the forward 20.00Hz and reverse 40.00Hz is reverse 20.00Hz.

**F00.08=1: main frequency source A - auxiliary frequency source B**

The main and auxiliary operation result is the difference between the two items, and may be positive or negative. That is, the result of the forward 20.00Hz and reverse 40.00Hz is forward 50.00Hz (upper frequency limit F00.18=50.00).

**F00.08=2: the larger of main and auxiliary operation results**

The main and auxiliary operation result is the larger of the two items, and may be positive or negative. That is, the result of the forward 20.00Hz and reverse 40.00Hz is forward 20.00Hz.

**F00.08=3: the smaller of main and auxiliary operation results**

The main and auxiliary operation result is the smaller of the two items, and may be positive or negative. That is, the result of the forward 20.00Hz and reverse 40.00Hz is reverse 40.00Hz.

**F00.08=4: main frequency source A - auxiliary frequency source B, the result is greater than or equal to zero**

The main and auxiliary operation result is the difference between the two items, and the result is greater than or equal to zero, that is, the operation results of 20.00Hz forward and 40.00Hz reverse are 0Hz.

**F00.08=5: main frequency source A + auxiliary frequency source B, the result is greater than or equal to zero**

The main and auxiliary operation result is the sum of the two items, and the result is greater than or equal to zero, that is, the operation result of forward 20.00Hz and reverse 40.00Hz is 0Hz (the upper frequency is F00.18).

Function code	Function code name	Parameter description	Unit	Default setting	Attribute	mailing address
F00.09	Reference options of auxiliary frequency source B in main and auxiliary operation	0: relative to the maximum frequency 1: relative to main frequency source A		0	○	0x0009

During the main and auxiliary operations, the range of the auxiliary frequency source B depends on the selected object, maximum frequency by default. If selected relative to the main frequency source A (F00.09=1), the range of the auxiliary frequency source B will change along with that of the main frequency source A (according to the maximum frequency by default).

Function code	Function code name	Parameter description	Unit	Default setting	Attribute	mailing address
F00.10	Gain of main frequency source	0.0~300.0	%	100.0	●	0x000A

F00.11	Gain of auxiliary frequency source	0.0~300.0	%	100.0	●	0x000B
F00.12	Synthetic gain of main and auxiliary frequency sources	0.0~300.0	%	100.0	●	0x000C
F00.13	Analog adjustment of synthetic frequency	0: synthetic frequency of main and auxiliary channels 1: AI1 * synthetic frequency of main and auxiliary channels 2: AI2 * synthetic frequency of main and auxiliary channels 3: reserved 4: reserved 5: high frequency pulse (PULSE) * synthetic frequency of main and auxiliary channels		0	○	0x000D

Such parameters are mainly used to adjust the gain of each setting source, as shown in Fig. 7-8. Both the main frequency source A and the auxiliary frequency source B have a set gain. When synthesis is selected via the function code F00.06, a synthetic gain will be generated. The final setting is limited by the analog adjustment and upper and lower frequency limits.

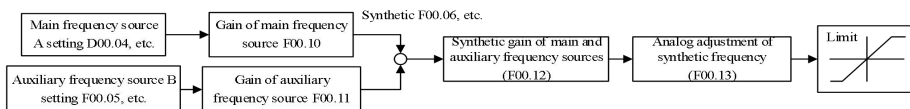

Fig. 7-8 Frequency Source Setting Control (Gain Description)

The gain type function codes (F00.10 to F00.12) are for “multiplication”, i.e. “set value = original set value \* gain”. Below is only the description of the analog adjustment (F00.13).

**F00.13=0: synthetic frequency of main and auxiliary channels**

The synthetic frequency is directly set to the synthetic frequency of main and auxiliary channels.

**F00.13=1: AI1 \* synthetic frequency of main and auxiliary channels**

**F00.13=2: AI2 \* synthetic frequency of main and auxiliary channels**

The synthetic frequency is directly set to “AI (percentage) \* synthetic frequency of main and auxiliary channels”.

For the details of AI1-AI2 and X5, refer to the F00.04 description. They have the same meaning. 100.00% is the percentage relative to the main and auxiliary synthetic frequency.

**F00.13=5: High frequency pulse (PULSE) \* synthetic frequency of main and auxiliary channels**

The synthetic frequency is directly set to “HDI (percentage) \* synthetic frequency of main and auxiliary channels”.

For the details of AI1-AI2 and X5, refer to the F00.04 description. They have the same meaning. 100.00% is the percentage relative to the main and auxiliary synthetic frequency.

Function code	Function code name	Parameter description	Unit	Default setting	Attribute	mailing address
F00.14	Acceleration time 1	0.00 ~ 650.00 (F15.13=0) 0.0 ~ 6500.0 (F15.13=1) 0 ~ 65000 (F15.13=2)	s	15.00	●	0x000E
F00.15	Deceleration time 1	0.00 ~ 650.00 (F15.13=0) 0.0 ~ 6500.0 (F15.13=1) 0 ~ 65000 (F15.13=2)	s	15.00	●	0x000F

The acceleration time is the time for the output frequency to rise from 0.00Hz to the set value Fbase of F15.09 (reference frequency of the acceleration and deceleration time); and the deceleration time is the time for the output frequency to fall from Fbase to 0.00Hz, regardless of forward and reverse running. See Fig. 7-9.

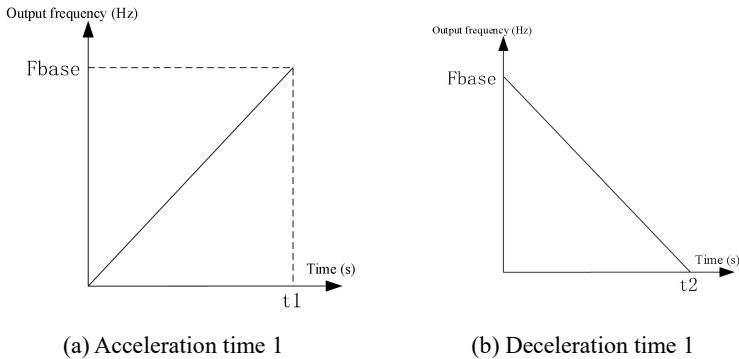

Fig. 7-9 Acceleration and Deceleration Time





Note that the acceleration and deceleration time is in 0.01 s, 0.1 s or 1s, depending on the F15.13.

Function code	Function code name	Parameter description	Unit	Default setting	Attribute	mailing address
F00.16	Maximum frequency	1.00~600.00	Hz	50.00	○	0x0010

The allowable maximum frequency of the inverter is represented by Fmax. The Fmax range is from 20.00 to 600.00Hz.

Function code	Function code name	Parameter description	Unit	Default setting	Attribute	mailing address
F00.17	Options of upper frequency limit control	0: set by F00.18 1: AI1 2: AI2 3: reserved 4: reserved 5: high frequency pulse input (X5) 6: percent setting of upper limit frequency communication 7: direct setting of upper limit frequency communication		0	○	0x0011
F00.18	Upper frequency limit	Lower frequency limit F00.19 to maximum frequency F00.16	Hz	50.00	●	0x0012
F00.19	Lower frequency limit	0.00 to upper frequency limit F00.18	Hz	0.00	●	0x0013

**F00.17=0: set by F00.18**

The upper frequency limit is set by F00.18.

**F00.17=1:AI1**

**F00.17=2:AI2**

The upper frequency limit depends on AI (percentage) \* F00.18.

For the details of AI1 and AI2, refer to the F00.04 description. They have the same meaning. 100.00% is the percentage relative to the set value of F00.18 (upper frequency limit).

**F00.17=5: High-frequency pulse input (X5)**

The upper frequency limit depends on HDI (percentage) \* F00.18.

For the details of AI1-AI2 and X5, refer to the F00.04 description. They have the same meaning. 100.00% is the percentage relative to F00.18 (maximum frequency).

**F00.17=6 or 7: communication setting**

The torque depends on the communication and the like.

- If the master-slave communication (F10.05=1) is enabled, and the inverter works as the slave (F10.06=0), the actual upper frequency limit is “700FH (master-slave communication setting) \* F10.08 (slave receiving proportional coefficient) \* F00.18 (upper frequency limit)”, and the 700FH data range is -100.00% to 100.00%, as detailed in Table 12-31.
- For general communication (F10.05=0):
  - a. **F00.17=6**, the actual frequency limit is “700AH (communication setting of the upper frequency limit) \* F00.18 (upper frequency limit)”.
  - b. **F00.17=7**, the actual frequency limit is “7017H (communication setting of the upper frequency limit)”.

The 700AH data range is 0.00% to 200.00%, and the 7017H data range is 0.00 to F00.16 (maximum frequency). For details, see Table 12-31.

F00.18 is the highest frequency allowed after the inverter is started. It is represented by Fup, ranging from Fdown to Fmax;

F00.19 is the lowest frequency allowed after the inverter is started. It is represented by Fdown, ranging from 0.00Hz to Fup.

1. The upper and lower frequency limits should be set carefully according to the nameplate parameters and operating conditions of the actually controlled motor, and the motor should be prevented from long-time operation at the low frequency; otherwise, the motor life may be shortened due to overheat.

2. Relationship of the maximum frequency, upper frequency limit and lower frequency limit:  $0.00\text{Hz} \leq F_{\text{down}} \leq F_{\text{up}} \leq F_{\text{max}} \leq 600.00\text{Hz}$ ;

3. When the set frequency is lower than F00.19 (lower frequency limit), the running mode is dependent on F15.33.

Function code	Function code name	Parameter description	Unit	Default setting	Attribute	mailing address
F00.20	Running direction	0: consistent direction 1: opposite direction		0	●	0x0014

The rotation direction of the motor can be changed by modifying this function code instead of motor wiring. This is equivalent to the change in the rotation direction of the motor by adjusting any two wires of the motor (U, V, W).

1. After the parameters are initialized, the rotation direction of the motor will return to its original status.
-  2. Be careful to conduct the aforesaid operation where it is forbidden to change the rotation direction of the motor after system debugging.
3. When the inverter is prohibited from reverse running (e.g. F00.21=1), this function is invalid.

Function code	Function code name	Parameter description	Unit	Default setting	Attribute	mailing address
F00.21	Reverse control	0: allow forward/reverse running 1: prohibit reversing		0	○	0x0015
F00.22	Duration of forward and reverse dead zone	0.00~650.00	s	0.00	●	0x0016

**F00.21=0: reversing running is allowed.**

The rotation direction of the motor is controlled by the setting of the F/R terminal or F00.20.

**F00.21=1: reverse running is prohibited.**

The motor can only work in one direction, and the F/R terminal and F00.20 are invalid.

**Select the forward/reverse status of the motor.**

If F00.22=0.00 is set, forward and reverse running is subject to smooth transition.

If F00.22≠0 is set, when the speed drops to 0.00Hz during forward and reverse switching, the inverter will work at 0.00Hz within the duration of the forward and reverse dead zone (F00.22) and then in the opposite direction to the set frequency. See Fig. 7- 10.

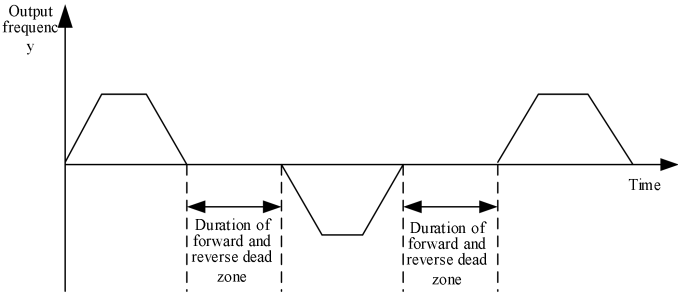

Fig. 7- 10 Schematic Diagram of Duration of Forward/Reverse Dead Zone

When reverse running is allowed, the running direction of the inverter depends on the



status of the F/R terminal and the set value of F00.20. If the set forward running direction of the inverter is inconsistent with the desired rotation direction of the motor, exchange any two of the output terminal wires (U, V, W) of the inverter, or set F00.20 to the opposite value.

Function code	Function code name	Parameter description	Unit	Default setting	Attribute	mailing address
F00.23	Carrier frequency	1.0~16.0 (rated power of the inverter: less than 4.00kW) 1.0~10.0 (rated power of the inverter: 5.50~7.50kW) 1.0~8.0 (rated power of inverter 11.00 - 45.00kW) 1.0~4.0 (rated power of inverter 55.00 - 90.00kW) 1.0~3.0 (rated power of inverter: 110.00kW and above)	kHz	4.0 (7.5 and below) /2.0	●	0x0017

Increasing the carrier frequency can reduce the motor noise, but will lead to the heat increase of the inverter. When the carrier frequency is higher than the default value and increased by 1kHz, the load needs to be derated to some extent. Please set F00.24=1. The actual carrier frequency of the inverter will be adjusted automatically according to the actual situation.

The recommended relationship between the rated power and carrier frequency of the inverter is shown in Table 7-4.

Table 7-4 Relationship between Rated Power and Carrier Frequency Setting of Inverter

Inverter power Pe	Pe≤4kW	5.5kW~7.5kW	11kW~45kW	55kW~90kW	110kW~560kW
Rated carrier frequency	4.0kHz		2.0kHz		
Maximum allowable carrier frequency	16.0 kHz	10.0kHz	8.0kHz	4.0kHz	3.0kHz

Function code	Function code name	Parameter description	Unit	Default setting	Attribute	mailing address
F00.24	Automatic adjustment of carrier	0: invalid 1: valid 1 2: valid 2		1	○	0x0018

frequency					
-----------	--	--	--	--	--

**F00.24=0: invalid**

The carrier frequency is dependent on F00.23, but limited by the allowable maximum carrier frequency. It will not change during operation.

**F00.24=1: valid 1**

The carrier frequency is affected by the inverter temperature and load based on the F00.23 setting. If the inverter temperature is too high or the load is too heavy, the carrier frequency will be limited. When the set carrier frequency F00.23 is greater than the limit, the carrier frequency of the inverter will be the limit during operation.

**F00.24=2: valid 2**

The carrier frequency is auto-tuned on the basis of the F00.23 setting.

Function code	Function code name	Parameter description	Unit	Default setting	Attribute	mailing address
F00.25	Noise suppression of carrier frequency	0: invalid 1: valid		0	○	0x0019
F00.27	Noise suppression intensity	10~150	Hz	100	●	0x001B

When the noise suppression function is enabled (F00.25=1), the motor noise can be suppressed to a certain extent.

Function code	Function code name	Parameter description	Unit	Default setting	Attribute	mailing address
F00.28	Options of motor parameter group	0: parameter group of motor 1 1: parameter group of motor 2		0	○	0x001C

The EM730 series inverter supports time-sharing control of two motors. The motor parameters and control parameters can be set separately. The corresponding parameters of the motor 1 are in the F00 group, F01 group and F06 group, and those of the motor 2 are in the F14 group.

The valid motor can be selected in conjunction with F00.28 and the input function “Motor 1/Motor 2 switching”, as detailed in Table 7-5.

Table 7-5 Details of Motor Parameter Group Options

F00.28: Motor parameter group options	30: motor 1/motor 2 switching	Valid motor	Related parameter group
---------------------------------------	-------------------------------	-------------	-------------------------

User Manual of EM730 Series Inverter

0: parameter group of motor 1	Invalid	Motor 1	F00/F01/F06
	Valid	Motor 2	F14
1: parameter group of motor 2	Invalid	Motor 2	
	Valid	Motor 1	F00/F01/F06

Function code	Function code name	Parameter description	Unit	Default setting	Attribute	mailing address
F00.29	User password	0 - 65535		0	○	0x001D

F00.29 is used to set a password to enable the password protection and prevent the function code parameters of the inverter from modification by unauthorized personnel. If the password is set to 0, the password function will be invalid. When a non-zero user password is set, all parameters (except this function code) can only be viewed and are not modifiable.

Function code	Function code name	Parameter description	Unit	Default setting	Attribute	mailing address
F00.31	Frequency resolution	0: 0.01Hz 1: 0.1Hz (speed unit: 10rpm)		0	○	0x001F

**F00.31=0:** The frequency resolution is 0.01Hz, corresponding to the frequency of 50.00Hz. The maximum frequency in this mode is 600.00Hz.

**F00.31=1:** The frequency resolution is 0.1Hz, corresponding to the frequency of 50.00Hz. The maximum frequency in this mode is 3000.0Hz. It is suitable for high-frequency spindle motors.

Function code	Function code name	Parameter description	Unit	Default setting	Attribute	mailing address
F00.35	Power supply voltage selection	0: 380V 1: 440V		0	○	0x0023

**F00.55=0: 380V**

The voltage of the applied power supply is 380V.

**F00.55=1: 440V**

The voltage of the applied power supply is 440V. When the function code is set to 440V, the corresponding dynamic braking voltage and stall overvoltage will increase accordingly.

## 7.2 Motor 1 parameter group of F01 group

Function	Function code	Parameter description	Unit	Default	Attribute	mailing
----------	---------------	-----------------------	------	---------	-----------	---------

code	name		setting		address
F01.00	Motor type	0: ordinary asynchronous motor 1: variable-frequency asynchronous motor 2: permanent magnet synchronous motor	0	○	0x0100

The EM730 series inverter supports asynchronous and synchronous motors. Please set this parameter correctly according to the actual situation.

Function code	Function code name	Parameter description	Unit	Default setting	Attribute	mailing address
F01.01	Rated power of electric motor	0.10~650.00	kW	Depending on the motor type	○	0x0101
F01.02	Rated voltage of motor	50~2000	V	Depending on the motor type	○	0x0102
F01.03	Rated current of motor	0.01 to 600.00 (rated power of motor: ≤ 75 kW) 0.1 to 6000.0 (rated power of motor: > 75 kW)	A	Depending on the motor type	○	0x0103
F01.04	Rated frequency of motor	0.01~600.00	Hz	Depending on the motor type	○	0x0104
F01.05	Rated speed	1~60000	rpm	Depending on the motor type	○	0x0105
F01.06	Motor winding connection	0:Y 1:Δ		Depending on the motor type	○	0x0106
F01.07	Rated power factor of motor	0.600~1.000		Depending on the motor type	○	0x0107
F01.08	Motor efficiency	30.0~100.0	%	Depending on the motor	○	0x0108

				type		
--	--	--	--	------	--	--

The above function codes are the nameplate parameters of the asynchronous motor. When the motor is connected to the inverter for the first time, regardless of VF control or vector control, the above parameters must be correctly set according to the motor nameplate before operation.

When the rated power (F01.01) of the motor is changed, the values of F01.03 to F01.08 of the inverter will change automatically. Pay attention to this during operation.

Function code	Function code name	Parameter description	Unit	Default setting	Attribute	Mailing address
F01.09	Stator resistance of asynchronous motor	1~60000 (rated power of motor: ≤ 75 kW) 0.1~6000.0 (rated power of motor: > 75kW)	mΩ	Depending on the motor type	○	0x0109
F01.10	Rotor resistance of asynchronous motor	1~60000 (rated power of motor: ≤ 75 kW) 0.1~6000.0 (rated power of motor: > 75kW)	mΩ	Depending on the motor type	○	0x010A
F01.11	Leakage inductance of asynchronous motor	0.01 to 600.00 (rated power of motor: ≤ 75 kW) 0.001 to 60.000 (rated power of motor: > 75 kW)	mH	Depending on the motor type	○	0x010B
F01.12	Mutual inductance of asynchronous motor	0.1 to 6000.0 (rated power of motor: ≤ 75 kW) 0.01 to 600.00 (rated power of motor: > 75 kW)	mH	Depending on the motor type	○	0x010C
F01.13	No-load excitation current of asynchronous motor	0.01 to 600.00 (rated power of motor: ≤ 75 kW) 0.1 to 6000.0 (rated power of motor: > 75 kW)	A	Depending on the motor type	○	0x010D

The function codes F01.09 to F01.13 are the parameters of the asynchronous motor. They are usually unavailable to users. Please get them through motor parameter self-identification (F01.34).

When the motor parameters (F01.01 to F01.08) are modified, the values of F01.09 to F01.13 of the inverter will change automatically. Pay attention to this during operation.

Before the motor parameter self-identification, be sure to set F01.00 to F01.08 correctly according to the actual situation.



The specific meanings of motor parameters are shown in Fig. 7-11:

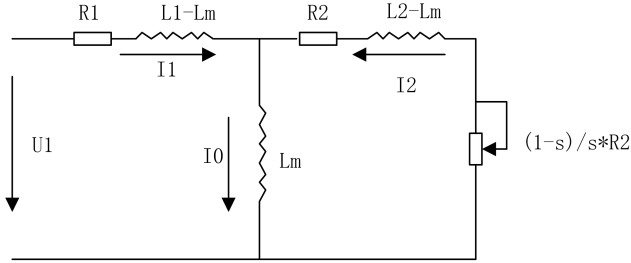

Fig. 7-11 Steady-state Equivalent Model of Asynchronous Motor

R1, L1, R2, L2, Lm, and I0 in the figure represent: stator resistance, stator inductance, rotor resistance, rotor inductance, mutual inductance, no-load excitation current.

Function code	Function code name	Parameter description	Unit	Default setting	Attribute	mailing address
F01.14	Magnetic saturation coefficient 1 of asynchronous motor	10.00 ~ 100.00	%	87.00	○	0x010E
F01.15	Magnetic saturation coefficient 2 of asynchronous motor	10.00 ~ 100.00	%	80.00	○	0x010F
F01.16	Magnetic saturation coefficient 3 of asynchronous motor	10.00 ~ 100.00	%	75.00	○	0x0110
F01.17	Magnetic saturation coefficient 4 of asynchronous motor	10.00 ~ 100.00	%	72.00	○	0x0111
F01.18	Magnetic saturation coefficient 5 of asynchronous motor	10.00 ~ 100.00	%	70.00	○	0x0112

The magnetic saturation coefficient of the asynchronous motor is automatically set during the motor parameter self-identification. Users do not need to set it under normal circumstances.

Function code	Function code name	Parameter description	Unit	Default setting	Attribute	mailing address
F01.19	Stator resistance of synchronous motor	1~ 60000 (rated power of motor: ≤75kW) 0.1 to 6000.0 (rated power of motor: > 75 kW)	mΩ	Model Confirm	○	0x0113

F01.20	d-axis inductance of synchronous motor	0.01 to 600.00 (rated power of motor: ≤ 75 kW) 0.001 to 60.000 (rated power of motor: > 75 kW)	mH	Model Confirm	○	0x0114
F01.21	q-axis inductance of synchronous motor	0.01 to 600.00 (rated power of motor: ≤ 75 kW) 0.001 to 60.000 (rated power of motor: > 75 kW)	mH	Model Confirm	○	0x0115
F01.22	Counter electromotive force of synchronous motor	10.0~2000.0 (counter electromotive force of rated speed)	V	Model Confirm	○	0x0116
F01.23	Initial electrical angle of synchronous motor	0.0~359.9 (valid for synchronous motor)		0.0	○	0x0117

The function codes F01.19 to F01.23 are the parameters of the synchronous motor. They are usually unavailable to users. Please get them through motor parameter self-identification (F01.34).

Before the motor parameter self-identification, be sure to set F01.00 to F01.08 correctly according to the actual situation. In particular, select the motor type (F01.00=2) correctly.

Function code	Function code name	Parameter description	Unit	Default setting	Attribute	mailing address
F01.34	Motor parameter self-learning	0: no operation 1: static self-learning of asynchronous motor 2: rotation self-learning of asynchronous motor 11: static self-learning of synchronous motor 12: rotary self-learning of synchronous motor		0	○	0x0118

**F01.34=0:** not identified

**F01.34=1:** the asynchronous motor remains stationary during parameter self-identification.

Prior to the static self-learning of the asynchronous motor, please set the motor type (F01.00) and motor nameplate parameters (F01.01 to F01.08) correctly. Relevant parameters (F01.09 to F01.13) of the asynchronous motor can be obtained during static self-learning.

This mode is mainly used when the motor cannot rotate. Static self-learning has poorer effects than rotary self-learning.

**F01.34=2:** the asynchronous motor rotates during parameter self-identification.

Prior to the rotary self-learning of the asynchronous motor, please set the motor type (F01.00) and motor nameplate parameters (F01.01 to F01.08) correctly. Relevant parameters (F01.09 to F01.18) of the asynchronous motor can be obtained during rotary self-learning.

This mode is mainly used when the motor can rotate. However, loads should be avoided or minimized; otherwise, self-learning will have poor effects.

**F01.34=11:** the synchronous motor remains stationary during parameter self-identification.

Prior to the static self-learning of the synchronous motor, please set the motor type (F01.00) and motor nameplate parameters (F01.01 to F01.05) correctly. Relevant parameters (F01.19 to F01.21) of the synchronous motor and current loop parameters (F06.12 to F06.15) can be obtained during static self-learning.

This mode is mainly used when the motor cannot rotate. It is necessary to manually enter the counter electromotive force (F01.22).

**F01.34=12:** the synchronous motor rotates during parameter self-identification.

Prior to the rotary self-learning of the synchronous motor, please set the motor type (F01.00) and motor nameplate parameters (F01.01 to F01.05) correctly. Relevant parameters (F01.19 to F01.21) of the synchronous motor, current loop parameters (F06.12 to F06.15) and counter electromotive force (F01.22) can be obtained during rotary self-learning.

This mode is mainly used when the motor can rotate. However, loads should be avoided or minimized; otherwise, self-learning will have poor effects.

1. Motor parameter self-learning is valid only in the keyboard-controlled start/stop mode (F00.02=0): Set F01.34 to the corresponding value, and press the ENTER key



for confirmation and then the RUN key  to start motor parameter self-learning. After the parameter self-learning, F01.34 of the inverter will be automatically set to 0;



2. If there is an overcurrent or overvoltage protection during self-learning, extend the acceleration & deceleration time and try again.

3. The first group of motor parameters is taken as an example above. For the second group of motor parameters, refer to the above description.

### 7.3 Function Parameter Group of Input Terminal of F02 Group

The standard EM730 series inverter is equipped with five multi-function digital input

terminals (X1 to X5) and two analog input terminals (AI1 and AI2, to be used with the corresponding function set to digital input, as detailed in the F02.31 description).

Function code	Function code name	Parameter description	Unit	Default setting	Attribute	mailing address
F02.00	Options of X1 digital input function	See Table 7-6 Function List of Multi-function Digital Input Terminals		1	○	0x0200
F02.01	Options of X2 digital input function			2	○	0x0201
F02.02	Options of X3 digital input function			11	○	0x0202
F02.03	Options of X4 digital input function			12	○	0x0203
F02.04	Options of X5 digital input function			13	○	0x0204
F02.07	Options of AI1 digital input function			0	○	0x0207
F02.08	Options of AI2 digital input function			0	○	0x0208

The terminals X1 to X5, AI1 and AI2 are seven multi-function input terminals. The functions of the input terminals can be defined by setting the values of the function codes F02.00 to F02.14.

For example, if you define F02.00=1, the function of the X1 terminal is “RUN”. If the command source is set to terminal control (F00.02=1) and the X1 terminal input is valid, the “RUN” function of the inverter will be enabled. Specific options are described in Table 7-6.

If multiple terminals are set to the same function (except for #34 function terminal), the function status is dependent on the “OR logic” of the two terminals. In the case of F02.00=1 and F02.04=1, once one of the terminals X1 or X5 is valid, the “RUN” function of the inverter will be enabled.

Table 7-6 Function List of Multi-function Digital Input Terminals

Settings	Function	Description
0	No function	Disable the protection terminal or set it to “0: Unavailable” to prevent malfunction.
1	Running terminal (RUN)	When the command source is set to terminal control (F00.02=1), and the function terminal is valid, the inverter will execute the corresponding RUN function according to the set value of the terminal control mode option (F00.03). (See the explanation of the function code F00.03 for details.)
2	Running direction	When the command source is set to terminal control

	F/R	(F00.02=1), and the function terminal is valid, the inverter will execute the corresponding F/R function according to the set value of the terminal control mode option (F00.03). (See the explanation of the function code F00.03 for details.)
3	Stop control of three-line operation	When the command source is set to terminal control (F00.02=1), the terminal control mode is set to three-line control (F00.03=2/3) and the function terminal is valid, the inverter will execute the stop command. (See the explanation of the function code F00.03 for details.)
4	Forward jog (FJOG)	When the command source is set to terminal control (F00.02=1), and the function terminal FJOG is valid, the inverter will run forward; if the function terminal RJOG is valid, the inverter will run reversely; and if the two function terminals are valid at the same time, the inverter will decelerate to stop.
5	Reverse jog (RJOG)	★: When reverse running is prohibited, the reverse jog will be invalid.
6	Terminal UP	If the function terminal UP is valid, the frequency offset will be increase at the rate defined by F12.11; and if the function terminal DOWN is valid, the frequency offset will decrease at the rate defined by F12.11.
7	Terminal DOWN	If the UP/DOWN offset clear terminal is valid, the frequency offset will be cleared to 0.
8	Clear UP/DOWN offset	Final set frequency of the frequency source A = set frequency of the frequency source A + UP/DOWN offset. ★: The UP/DOWN function is valid only when the main frequency source A is involved in setting. The offset frequency can be viewed via F18.15. The function of the terminal UP/DOWN is the same as that of the UP/DOWN on the keyboard.
9	Free stop	If this function terminal is valid during inverter operation, the output will be blocked, the inverter will stop in the free status, and the motor will not be controlled by the inverter.
10	Reset protection	If the inverter is subject to protection and the faulty point is eliminated, you can use this terminal to reset the inverter. This has the same function as the Reset key on the keyboard.
11	Multi-segment speed terminal 1	When the speed control and main frequency source A are involved in setting, four function input terminals can be defined as multi-segment speed terminals. The current set frequency of the inverter depends on the code combination of these four terminals and the settings of related function codes. Details are given in the following table. (0/1: the current function terminal

12	Multi-segment speed terminal 2	is invalid/valid.) ★: When a function has no corresponding input terminal options, it is invalid (0) by default.					
		14	13	12	11	Set frequency of the inverter	
13	Multi-segment speed terminal 3	0				Depending on the option (F00.04) of the main frequency source A	
		0	0	0	1	Multi-segment speed 1 (F08.00)	
		0	0	1	0	Multi-segment speed 2 (F08.01)	
		0	0	1	1	Multi-segment speed 3 (F08.02)	
		0	1	0	0	Multi-segment speed 4 (F08.03)	
		0	1	0	1	Multi-segment speed 5 (F08.04)	
		0	1	1	0	Multi-segment speed 6 (F08.05)	
		0	1	1	1	Multi-segment speed 7 (F08.06)	
		1	0	0	0	Multi-segment speed 8 (F08.07)	
		1	0	0	1	Multi-segment speed 9 (F08.08)	
14	Multi-segment speed terminal 4	1	0	1	0	Multi-segment speed 10 (F08.09)	
		1	0	1	1	Multi-segment speed 11 (F08.10)	
		1	1	0	0	Multi-segment speed 12 (F08.11)	
		1	1	0	1	Multi-segment speed 13 (F08.12)	
		1	1	1	0	Multi-segment speed 14 (F08.13)	
		1	1	1	1	Multi-segment speed 15 (F08.14)	
		15	Multi-segment PID terminal 1	The 4-segment PID setting can be performed via these two terminals, as detailed in the following table (0/1: the current function terminal is invalid/valid).			
				16	15	Multi-segment PID setting	
16	Multi-segment PID terminal 2	0	0	Depending on the PID setting source (F09.00)			
		0	1	Multi-segment PID setting 1 (F09.32)			
		1	0	Multi-segment PID setting 2 (F09.33)			
		1	1	Multi-segment PID setting 3 (F09.34)			
17	Multi-segment torque terminal 1	The 4-segment torque setting can be performed via these two terminals, as detailed in the following table (0/1: the current function terminal is invalid/valid).					
		18	17	Multi-segment torque setting			
18	Multi-segment torque terminal 2	0	0	Depending on the torque setting source option (F13.01)			
		0	1	Multi-segment torque 1 (F13.03)			
		1	0	Multi-segment torque 2 (F13.04)			
		1	1	Multi-segment torque 3 (F13.05)			

19	Acceleration and deceleration time terminal 1	The inverters of this series have four groups of acceleration and deceleration time in total. You can define two function input terminals as acceleration and deceleration time terminals. The current acceleration/deceleration time of the inverter depends on the code combination of these four terminals and settings of related function codes. Details are given in the following table. (0/1: the current function terminal is invalid/valid); or see the function codes F15.03 to F15.13 for details.															
20	Acceleration and deceleration time terminal 2	<table border="1" style="width: 100%; border-collapse: collapse;"> <thead> <tr> <th style="width: 10%; text-align: center;">20</th> <th style="width: 10%; text-align: center;">19</th> <th style="width: 80%;">Acceleration and deceleration time</th> </tr> </thead> <tbody> <tr> <td style="text-align: center;">0</td> <td style="text-align: center;">0</td> <td>The first group (acceleration time: F00.14; deceleration time: F00.15)</td> </tr> <tr> <td style="text-align: center;">0</td> <td style="text-align: center;">1</td> <td>The second group (acceleration time: F15.03; deceleration time: F15.04)</td> </tr> <tr> <td style="text-align: center;">1</td> <td style="text-align: center;">0</td> <td>The third group (acceleration time: F15.05; Deceleration time: F15.06)</td> </tr> <tr> <td style="text-align: center;">1</td> <td style="text-align: center;">1</td> <td>The fourth group (acceleration time: F15.07; Deceleration time: F15.08)</td> </tr> </tbody> </table>	20	19	Acceleration and deceleration time	0	0	The first group (acceleration time: F00.14; deceleration time: F00.15)	0	1	The second group (acceleration time: F15.03; deceleration time: F15.04)	1	0	The third group (acceleration time: F15.05; Deceleration time: F15.06)	1	1	The fourth group (acceleration time: F15.07; Deceleration time: F15.08)
		20	19	Acceleration and deceleration time													
		0	0	The first group (acceleration time: F00.14; deceleration time: F00.15)													
		0	1	The second group (acceleration time: F15.03; deceleration time: F15.04)													
1	0	The third group (acceleration time: F15.05; Deceleration time: F15.06)															
1	1	The fourth group (acceleration time: F15.07; Deceleration time: F15.08)															
21	Acceleration and deceleration prohibition	When the acceleration and deceleration prohibition terminal is valid, the execution of acceleration and deceleration commands will be prohibited, and the output frequency of the inverter will remain unchanged. The inverter in the overcurrent protection status will run based on the current limit.															
22	Operation pause	The inverter decelerates to stop, but all running parameters will be kept in the memory, such as PLC and PID parameters. When this terminal is invalid, the inverter will restore the running status before stop.															
23	External protection input	Using this terminal, you can input the protection signal of the external device, to facilitate protection monitoring and protection of the external device via the inverter. Upon receiving an external protection signal, the inverter will display “E14” and freely stop running.															
24	Switching of RUN command to keyboard	The current command channel depends on the status of these two terminals and setting of F00.02. The priority is as follows: “24: switching of RUN command to keyboard” > “25: switching of RUN command to communication” > “F00.02: command source option”. Refer to the F00.02 description for details.															
25	Switching of RUN command to communication																
26	Frequency source switching	This terminal is mainly used to switch the frequency sources in conjunction with the function code F00.06. When F00.06=3 to 5, this terminal will be valid. Refer to the F00.06 description.															
27	Clearing of regular running time	The regular running function is defined by F16.05. This terminal can be used to clear the running time (reset the remaining time of regular running). Refer to the F16.05															

		description.
28	Speed control/torque control switching	These two terminals are used to change the current inverter control mode in conjunction with F13:00. When #28 terminal is valid, speed control and torque control can be switched; and when #29 terminal is valid, only speed control is enabled. See the F13.00 description.
29	Torque control prohibition	
30	Motor 1/Motor 2 switching	This terminal is used to determine the current valid motor in conjunction with F00.28. If #30 terminal is valid, the motors will be switched based on the F00.28 setting. See the F00.28 description.
31	Resetting of simple PLC status (running from the first segment, with the running time cleared)	When this terminal is valid, the simple PLC module will restart running from the first segment. To further understand this function, you can view the simple PLC description of the F08 group.
32	simple PLC time pause (keep running at current segment)	When this terminal is valid, the simple PLC module will keep running at the current segment. When this terminal is invalid, the simple PLC module will continue to run after running at the current segment.
33	Reserved	
34	counter input ( $\leq 250\text{Hz}$ )	It is a pulse input terminal that has the counting function. The input pulse frequency is limited to 250Hz or below, and only one terminal can be set with this function. See the description of the function codes F16.03 to F16.04.
35	High-speed count input ( $\leq 100\text{kHz}$ , only valid for X5)	It is a pulse input terminal that has the counting function. The input pulse frequency is limited to 100kHz or below. This is valid only for the terminal X5 (that is, only F02.06=35 can be set). See the description of the function codes F16.03 to F16.04.
36	Count clearing	This terminal is used to clear the counter that has a counting function.
37	Length counter input ( $\leq 250\text{Hz}$ )	This is the pulse input terminal that has a length counting function, the input pulse frequency is limited to 250Hz or below, and only one terminal can be set with this function. See the description of the function codes F16.01 to F16.02.
38	High-speed length count input ( $\leq 100\text{kHz}$ , only valid for X5)	This is the pulse input terminal that has a length counting function, and the input pulse frequency is limited to 100kHz or below. It is invalid only for the terminal X5 (that is, only F02.06=38 can be set). See the description of the function codes F16.01 to F16.02.
39	Length clearing	This length clearing terminal has a length counting function.
40	Pulse input ( $\leq 100\text{kHz}$ , only valid for	This is a pulse signal input terminal, and the input pulse frequency is limited to 100kHz or below. It is valid only for the



	X5)	terminal X5. ★: This is used only to set the equivalent AI percentage instead of other special functions (e.g. counting). When F00.04=5, you need to set F02.06=40 and the set frequency pulse needs to be inputted from the terminal X5.
41	Process PID pause	When this terminal is valid, PID adjustment will be stopped, and the output of the process PID module will remain unchanged. For more information, refer to the description of the function code F09.18.
42	Process PID integral pause	When this terminal is valid, the PID integral adjustment will be suspended, but the proportional and differential adjustment of the PID will be still valid. This function is known as integral separation. See the F09.20 description.
43	PID parameter switching	If the digital input terminal (F09.11=1) for PID parameter switching is valid, PID parameters will be switched. See the description of the function codes F09.05 to F09.13.
44	PID positive/negative switching	When this terminal is valid, the PID positive/negative modes will be switched. See the description of the function code F09.04.
45	Stop and DC braking	When a stop command is triggered and the frequency reaches the starting frequency (F04.20) for direct braking during stop, braking will be enabled. The braking time is subject to the longer of the terminal closing time and stop/DC braking time (F04.22).
46	DC braking at stop	The stop command is not triggered. When there is a stop command, and the frequency reaches the starting frequency (F04.20) for direct braking during stop, braking will be enabled. The braking time is subject to the longer of the terminal closing time and stop/DC braking time (F04.22).
47	Immediate DC braking	The inverter will immediately stop running and be subject to DC braking at the current frequency. The braking current is dependent on the DC braking current (F04.21) in stop.
48	Fastest deceleration to stop	The inverter will stop running within the minimum allowable acceleration and deceleration time.
49	Reserved	
50	External stop	When this terminal is valid, the inverter will stop running according to the set stop mode (F04.19) and acceleration/deceleration time 4 (F15.07/F15.08).
51	Switching of main frequency source to digital frequency setting	When the main frequency source A is involved in setting, the multi-segment speed model is not enabled and this terminal is valid, the main frequency source will be switched to the corresponding setting. The functions 51 to 56 can work independently, but subject to the priority. See the description of
52	Switching of main	

	frequency source to AI1	the function code F00.04 Table 7-3.
53	Switching of main frequency source to AI2	
55	Switching of main frequency source to high-frequency pulse input	
56	Switching of main frequency source to communication setting	
57	Inverter enabling	<p>When the inverter meets the operating conditions and the current function terminal is valid, the inverter is able to run. Otherwise, it will not run even if other operating conditions are met.</p> <p>★: Inverter enabling function: If no terminal is selected, this function is valid by default; if one terminal is selected, the status of the selected terminal will prevail; and if more than one terminal is selected and any selected terminal is invalid, this function will not be valid.</p>
58 - 67	Reserved	
68	Prohibition of reversing disabling	<p>It is only applicable to the straight wire drawing machines in winding applications.</p> <p>1: When the function of 69# input terminal is available and/or F00.21=1, 68# input terminal is available, and reversing disabling is prohibited, that is, reversing is allowed; otherwise, reversing disabling is not prohibited, that is, reversing is not allowed.</p> <p>2: When the function of 69# input terminal is available and/or F00.21=1, 68# input terminal is available, and reversing is disabled, that is, reversion is not allowed; otherwise, reversing disabling is not disabled, that is, reversing is allowed.</p>
69	Prohibition of reversing	When this terminal is valid, its function is the same as that in the case of F00.21=1.
70	Input terminal extension	When input terminal extension is set to this function, the digital input terminals X1~X5 of the frequency converter can be used as the extended input terminals of PLC and other peripheral devices. Whether the corresponding input terminal is valid can be obtained by reading the input terminal status of F18.22
71 - 78	Reserved	
121	External material	This is a dedicated function for winding applications, which is

	cutoff signal	used for external input of material cutoff detection. When material cutoff detection is an external signal and the terminal is closed (consistent with restrictions), E43 protection will be reported.
122	Wiring detection signal	This is a dedicated function for winding applications, which is used for wiring detection. When the valid or invalid time of the wiring detection signal expires, E44 protection will be reported.
123	Brake reset terminal	This is a dedicated function for winding applications. When the brake output is valid, this terminal can be closed to reset the brake output.

Function code	Function code name	Parameter description								Unit	Default setting	Attribute	mailing address
F02.15	Positive/negative logic 1 of digital input terminal	D7	D6	D5	D4	D3	D2	D1	D0		00000	○	0x020F
		*	*	*	X5	X4	X3	X2	X1				
		0: positive logic is valid in the closed state/invalid in the open state 1: negative logic is valid in the closed state/invalid in the open state											
F02.16	Positive/negative logic 2 of digital input terminal	D7	D6	D5	D4	D3	D2	D1	D0		00	○	0x0210
		*	*	*	*	*	*	A12	A11				
		0: positive logic is valid in the closed state/invalid in the open state 1: negative logic is valid in the closed state/invalid in the open state											

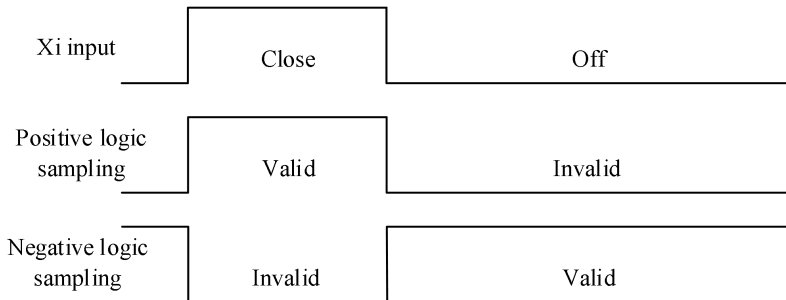

Fig. 7-12 Schematic Diagram of Positive/Negative Logic Sampling of Terminal  
When the bit is set to 0, the multi-function input terminal is valid in the closed status and

invalid in the open status;

When the bit is set to 1, the multi-function input terminal is valid in the open status and invalid in the closed status.

These function code are subject to bit operation. You only need to set the corresponding bit to 0 or 1. Take F02.15 as an example, as shown in the following table:

Table 7- 7 Function Code Details of Bit Operation

Setting item	*	*	*	X5	X4	X3	X2	X1
Corresponding bit	*	*	*	4	3	2	1	0
Settings	*	*	*	0/1	0/1	0/1	0/1	0/1

The seventh bit is reserved and cannot be set. The specific displayed value does not mean anything.

For example: To set the terminal X1 to reverse logic, you only need to set the 0<sup>th</sup> bit corresponding to X1 to 1, i.e. F02.15=xxx xxxx1.

To set the terminals X1 and X5 to reverse logic, you only need to set the 0<sup>th</sup> bit corresponding to X1 and 4<sup>th</sup> bit corresponding to X5 to 1. That is, 02.15=xxx 1xxx1.

★ This function is for logic matching with other external devices.

Function code	Function code name	Parameter description	Unit	Default setting	Attribute	mailing address
F02.17	Filtering times of digital input terminal	0~100; 0: no filtering; n: sampling once in n ms		2	○	0x0211

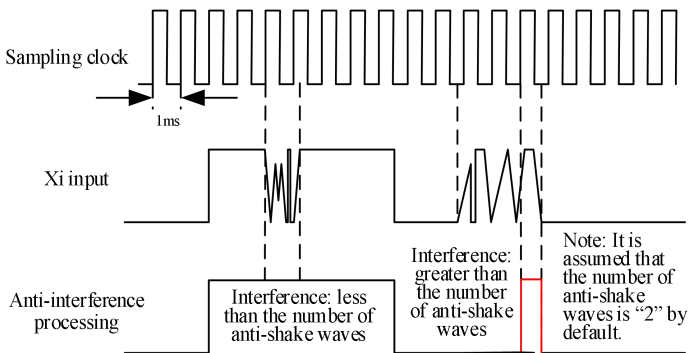

Fig. 7- 13 Schematic Diagram of Terminal Filter Sampling

Since the multi-function input terminal is triggered by level or pulse, digital filtering is

needed when the terminal status is read, in order to avoid interference.

★ The parameters of this code do not need to be adjusted under normal circumstances.

Where adjustment is required, pay attention to the relationship between the filtering time and terminal action duration, to avoid the susceptibility to interference due to insufficient filtering times or slow responses and command losses arising from excessive filtering times.

Function code	Function code name	Parameter description	Unit	Default setting	Attribute	mailing address
F02.18	X1 valid delay time	0.000~30.000	s	0.000	●	0x0212
F02.19	X1 invalid delay time	0.000~30.000	s	0.000	●	0x0213
F02.20	X2 valid delay time	0.000~30.000	s	0.000	●	0x0214
F02.21	X2 invalid delay time	0.000~30.000	s	0.000	●	0x0215
F02.22	X3 valid delay time	0.000~30.000	s	0.000	●	0x0216
F02.23	X3 invalid delay time	0.000~30.000	s	0.000	●	0x0217
F02.24	X4 valid delay time	0.000~30.000	s	0.000	●	0x0218
F02.25	X4 invalid delay time	0.000~30.000	s	0.000	●	0x0219

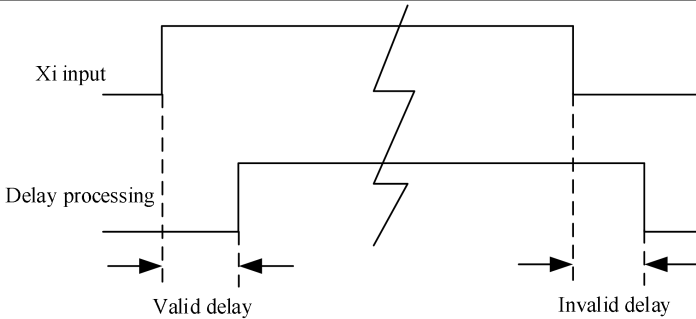

Fig. 7- 14 Schematic Diagram of Terminal Delay Sampling

In the event of changes in the status of the function terminal, a response will be made with delay according to the function code settings. Currently only the terminals X1 to X4 support this function. Specifically, it is embodied in: This function will take effect when the function terminal changes from the invalid to valid status and is maintained with the valid delay, and not take effect when the function terminal changes from the valid to invalid status and is maintained with the invalid delay.

★ If the function code is set to 0.000s, the corresponding delay will be invalid.

Function code	Function code name	Parameter description	Unit	Default setting	Attribute	mailing address
F02.31	Options of analog input function	<b>Ones place: AI1</b> 0: analog input 1: digital input (0 below 1V, 1 above 3V, the same as last time under 1~3V) <b>Tens place: AI2</b> 0: analog input 1: digital input (the same as above)		00D	○	0x021F

The analog input terminals AI1 and AI2 of the EM730 series inverter can be used as digital input terminals. You only need to set the corresponding bit to 1. To use the AI2 terminal as a digital terminal, you only need to set F02.31=xx1x. The analog input and digital logic conversion are as follows:

- When the input voltage of the terminal is less than 1V, its corresponding logic status will be invalid;
- When the input voltage of the terminal is greater than 3V, its corresponding logic status will be valid;
- When the input voltage of the terminal is within [1V, 3V], its corresponding logic status will remain unchanged.

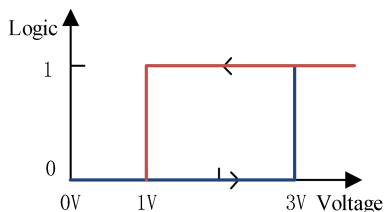

Fig. 7- 10 Correspondence between Analog Input Terminal Voltage and Current Logic Status

If it is used as an analog input terminal, the filter time and corresponding offset curve can be set via F02.32 to F02.60. The terminals AI1 to AI2 can be set separately.

Function code	Function code name	Parameter description	Unit	Default setting	Attribute	mailing address
F02.32	Options of analog input curve	<b>Ones place: options of AI1 curve</b> 0: curve 1 1: curve 2		10	○	0x0220

		2: curve 3 3: curve 4 <b>Tens place:</b> AI2 curve selection 0: curve 1 1: curve 2 2: curve 3 3: curve 4				
F02.33	Minimum input of curve 1	-10.00 ~ F02.35	V	0.10	●	0x0221
F02.34	Minimum input setting of curve 1	-100.0 ~ +100.0	%	0.0	●	0x0222
F02.35	Maximum input of curve 1	-10.00 ~ 10.00	V	9.90	●	0x0223
F02.36	Maximum input setting of curve 1	-100.0 ~ +100.0	%	100.0	●	0x0224
F02.37	Minimum input of curve 2	-10.00 ~ F02.39	V	0.10	●	0x0225
F02.38	Minimum input setting of curve 2	-100.0 ~ +100.0	%	0.0	●	0x0226
F02.39	Maximum input of curve 2	F02.37 ~ 10.00	V	9.90	●	0x0227
F02.40	Maximum input setting of curve 2	-100.0 ~ +100.0	%	100.0	●	0x0228
F02.41	Minimum input of curve 3	-10.00V~ F02.43	V	0.10	●	0x0229
F02.42	Minimum input setting of curve 3	-100.0 ~ +100.0	%	0.0	●	0x022A
F02.43	Input of inflection point 1 of curve 3	F02.41 ~ F02.45	V	2.50	●	0x022B
F02.44	Input setting of inflection point 1 of curve 3	-100.0 ~ +100.0	%	25.0	●	0x022C
F02.45	Input of inflection point 2 of curve 3	F02.43 ~ F02.47	V	7.50	●	0x022D
F02.46	Input setting of inflection point 2 of curve 3	-100.0 ~ +100.0	%	75.0	●	0x022E
F02.47	Maximum input of curve 3	F02.45 ~ 10.00	V	9.90	●	0x022F
F02.48	Maximum input setting of curve 3	-100.0 ~ +100.0	%	100.0	●	0x0230
F02.49	Minimum input of curve 4	-10.00 ~ F02.51	V	0.10	●	0x0231
F02.50	Minimum input setting of curve 4	-100.0 ~ +100.0	%	0.0	●	0x0232
F02.51	Input of inflection point 1 of curve 4	F02.49 ~ F02.53	V	2.50	●	0x0233
F02.52	Input setting of inflection point 1 of curve 4	-100.0 ~ +100.0	%	25	●	0x0234
F02.53	Input of inflection point 2 of	F02.51 ~ F02.55	V	7.50	●	0x0235

	curve 4					
F02.54	Input setting of inflection point 2 of curve 4	-100.0 ~ +100.0	%	75	●	0x0236
F02.55	Maximum input of curve 4	F02.53 ~ 10.00	V	8.80	●	0x0237
F02.56	Maximum input setting of curve 4	-100.0 ~ +100.0	%	100	●	0x0238
F02.57	AI1 filtering time	0.00 ~ 10.00	s	0.10	●	0x0239
F02.58	AI2 filtering time	0.00 ~ 10.00	s	0.10	●	0x023A
F02.59	Reserved					0x023B
F02.60	Reserved					0x023C

F02.32 is used to select the corresponding offset curve for each analog input terminal. In total, four groups of offset curves are available. Among them, the curves 1 and 2 indicate two-point offsets, while the curves 3 and 4 indicate four-point offsets. After selecting an offset curve, you can set the corresponding function code to meet the input requirements.

The filtering time can be adjusted according to the analog input and actual working conditions. The actual effect will prevail.

Function code	Function code name	Parameter description	Unit	Default setting	Attribute	mailing address
F02.61	AD sampling hysteresis	2 ~ 50		2	○	0x023D

This function code can be increased properly in the case of analog input hysteresis, long input lines or excessive on-site interference resulting in significant input fluctuations. In principle, this function code should be minimized.

Function code	Function code name	Parameter description	Unit	Default setting	Attribute	mailing address
F02.62	Selection of analog input AI1 type	0: 0~10V 3: -10~10V 4: 0~5V		0	○	0x023E
F02.63	Selection of analog input AI2 type	0: 0~10V 1: 4~20mA 2: 0~20mA 4: 0~5V		0	○	0x023F

Select the input type of AI1 and AI2: current or voltage type. Determine the upper and lower limits corresponding to the range.

**F02.62 =0: 0~10V**



AI1 is the voltage type, with a range of 0~10V. The input voltage (0~10V) corresponds to the setting 0% ~ 100%. 0V corresponds to 0%, and +10V corresponds to 100%.

**F02.62 =3: -10~10V**

AI1 is the voltage type, with a range of -10~10V. The input voltage (-10 to 10V) corresponds to the setting -100% to 100%. -10V corresponds to -100%, and +10V corresponds to 100%.

**F02.62 =4: 0~5V**

AI1 is the voltage type, with a range of 0~5V. The input voltage (0~5V) corresponds to the setting 0% ~ 100%. 0V corresponds to 0%, and +5V corresponds to 100%.

**F02.63 =0: 0~10V**

AI2 is the voltage type, with a range of 0~10V. The input voltage (0~10V) corresponds to the setting 0% ~ 100%. 0V corresponds to 0%, and +10V corresponds to 100%.

**F02.63=1: 4~20mA (adjust the short circuit cap of the control panel to the current mode)**

AI2 is the current type, with a range of 4~20mA. The input current (4~20mA) corresponds to the setting 0%~100%. The current of 4mA or less corresponds to 0%, and 20mA corresponds to 100%.

**F02.63=2: 0~20mA (adjust the short circuit cap of the control panel to the current mode)**

AI2 is the current type, with a range of 0~20mA. The input current (0~20mA) corresponds to the setting 0%~100%. 0mA corresponds to 0%, and 20mA corresponds to 100%.

**F02.63 =4: 0~5V**

AI2 is the voltage type, with a range of 0~5V. The input voltage (0~5V) corresponds to the setting 0%~100%. 0V corresponds to 0%, and +5V corresponds to 100%.

Function code	Function code name	Parameter description	Unit	Default setting	Attribute	mailing address
F02.66	Selection of AI2 current input impedance	0: 500Ω 1: 250Ω		0	○	0x0242

Select the AI2 current input impedance according to the actual situation on the site. The default input impedance is 500 ohms. In case of no 20mA output due to the poor load capacity of the input current source, the input impedance can be changed to 250 ohms.

### 7.4 Function Parameter Group of Output Terminal of F03 Group

The standard EM730 series inverter is equipped with one multi-function digital output terminal (Y1) and one relay output terminal (R1).

Function code	Function code name	Parameter description	Unit	Default setting	Attribute	Mailing address
F03.00	Options of Y1 output function	See Table 7-8 Function List of Multi-function Digital Output Terminals		1	○	0x0300
F03.02	Options of R1 output function			7	○	0x0302

Y1 and R1 are two multi-function digital output terminals. Their functions can be defined separately by setting the function codes F03.00 to F03.02.

For example, if you define F03.02=7, the function of the R1 terminal is “inverter protection”. When the inverter is in the protection status, the output of the function terminal R1 will be valid; and when the inverter is in the normal status, the output of the function terminal R1 will be invalid. Specific options are described in Table 7-8.

Table 7-8 Function List of Multi-function Digital Output Terminals

Settings	Function	Description
0	No output	The protection terminal will be disabled or set to “0: Unavailable” to prevent incorrect output.
1	Inverter running (RUN)	The inverter is in the status of slave running, slave stop, jog running or jog stop. The current output is valid in the aforesaid statuses and invalid in other statuses.
2	Up to output frequency (FAR)	When the  output frequency-set frequency  is less than or equal to the frequency detection width (F15.20) in the running status, the current output will be valid. When the inverter is not in the running status, or the  output frequency-set frequency  is beyond the frequency detection width (F15.20), the current output will be invalid. See the description of the function code F15.20.
3	Output frequency detection FDT1	When the  output frequency  is greater than the result of output frequency detection FDT1 (F15.21) in the running status, the current output will be valid. When the inverter is not in the running status, or the  output frequency  is less than or equal to the result of output frequency detection FDT1 (F15.21) minus FDT1 hysteresis (F15.22), the current output will be invalid. In other statuses, the current

		output will remain unchanged. See the description of the function codes F15.21 and F15.22.
4	Output frequency detection FDT2	When the  output frequency  is greater than the result of output frequency detection FDT2 (F15.23) in the running status, the current output will be valid. When the inverter is not in the running status, or the  output frequency  is less than or equal to the result of output frequency detection FDT2 (F15.23) minus FDT2 hysteresis (F15.24), the current output will be invalid. In other statuses, the current output will remain unchanged. See the description of the function codes F15.23 and F15.24.
5	Reverse running (REV)	When the running direction and acceleration/deceleration of the inverter is in the status of reverse acceleration, reverse deceleration or reverse constant speed, the current output will be valid. In other statuses, the current output will be invalid.
6	Jog	When the inverter is in the status of JOG running or JOG stop, the current output will be valid. In other statuses, the current output will be invalid.
7	Inverter protection	The current output will be valid when the inverter is in the protection status and invalid when the inverter is in other statuses.
8	Inverter ready to run (READY)	When the inverter has been powered on and completely initialized without any abnormality, the current output will be valid. When the inverter is not suitable for running, the current output will be invalid.
9	Reach the upper frequency limit	When the inverter is in the JOG or slave running status, the output frequency (F18.00) is greater than or equal to the upper frequency limit (F00.17  F00.18), and the set frequency (F18.01) is greater than or equal to the upper frequency limit (F00.17  F00.18), the current output will be valid. Otherwise, the current output will be invalid.
10	Reach the lower frequency limit	When the inverter is in the JOG or slave running status, the output frequency (F18.00) is less than or equal to the lower frequency limit (F00.19), and the set frequency (F18.01) is less than or equal to the lower frequency limit (F00.19), the current output will be valid. Otherwise, the current output will be invalid.
11	Valid current limit	When the output current (F18.06) is greater than or equal to

		the current limit (F07.12), the current output will be valid; when the output current (F18.06) is less than or equal to the current limit (F07.12) -5.0%, the current output will be invalid; and when the output current is an intermediate value, the current output will remain unchanged.
12	Valid overvoltage stall	When the output voltage (F18.07) is greater than or equal to the voltage of overvoltage stall control (F07.07), the current output will be valid; when the output voltage (F18.07) is less than or equal to the voltage of overvoltage stall control (F07.07) minus 10V, the current output will be invalid; and when the output voltage is an intermediate value, the current output will remain unchanged.
13	Complete simple PLC cycle	When the simple PLC is in the mode of stop after a single operation (F18.15=0), it will be stopped after one operation and the current output will be valid; when the simple PLC is in the mode of stop after a limited number of operations (F18.15=1), it will be stopped after the operations set by F08.16, and the current output will be valid; otherwise (e.g. further running, simple PLC status resetting), the current output will be invalid.
14	Reach the set count value	When the input pulse count value (F18.34) is greater than or equal to the set count value (F16.03), the current output will be valid; otherwise, the output will be invalid. See the description of function codes F16.03 to F16.04.
15	Reach the specified count value	When the input pulse count value (F18.34) is greater than or equal to the specified count value (F16.04), the current output will be valid; otherwise, the output will be invalid. See the description of function codes F16.03 to F16.04.
16	Reach the length (in meters)	When the input pulse conversion length (F18.34) is greater than or equal to the set length (F16.01), the current output will be valid; otherwise, the output will be invalid. See the description of the function codes F16.01 to F16.02.
17	Motor overload pre-alarm	When the current motor current is greater than or equal to the motor pre-alarm coefficient (F07.02), the current output will be valid; otherwise, the current output will be invalid.
18	Inverter overheat pre-alarm	When the inverter temperature is greater than or equal to the hot spot (-10 °C), the pre-alarm output will be valid; and when the inverter temperature is less than the hot spot minus 15 °C, the pre-alarm output will be invalid (5 °C

		hysteresis).
19	Reach the upper limit of PID feedback	If the PID feedback (F18.17) is greater than or equal to the upper limit (F09.16) of PID output during operation, the current output will be valid; otherwise, the output will be invalid.
20	Reach the lower limit of PID feedback	If the PID feedback (F18.17) is less than or equal to the lower limit (F09.17) of PID output during operation, the current output will be valid; otherwise, the output will be invalid.
21	Analog level detection ADT1	When the selected analog channel input is greater than or equal to the result of analog level detection (F15.26/28), the corresponding output will be valid; when the selected analog channel input is less than or equal to the result of analog level detection (F15.26/28) minus hysteresis (F15.27/29), the corresponding output will be invalid; and in other statuses, the current output will remain unchanged. See the description of the function codes F15.25 to F15.29.
22	Analog level detection ADT2	
24	Undervoltage status	When the DC bus voltage (F18.08) is less than or equal to the voltage of undervoltage stall control (F07.08), the current output will be valid; when the DC bus voltage (F18.08) is greater than or equal to the voltage of power failure end judgment (F07.09), and the holding time is greater than or equal to the determined delay time of power failure end (F07.10), the current output will be invalid.
26	Up to the set time	When it reaches the regular running time, the current output will be valid; otherwise, the output will be invalid. See the description of the function code F16.09.
27	Running at zero speed	When the inverter is in the JOG or slave running status and the output frequency (F18.00) is less than or equal to the zero servo start frequency (F04.29), the current output will be valid; otherwise, the current output will be invalid.
28 ~37	Reserved	
38	Off-load	The inverter is in the off-load status.
39	Reserved	
40	The current reached	When the actual output current of the motor reaches the set value, the output is valid.
41	The torque reached	When the actual torque of the motor reaches the set value, the output is valid.
42	The speed reached	When the actual motor speed reaches the set frequency, the

		output is valid.
43~46	Reserved	
47	PLC output	When this function is selected for the output terminal, the output of Y1 and R1 will be controlled by the corresponding bit of F03.31. If the corresponding bit is 1, the output will be valid; and if the corresponding bit is 0, the output will be invalid.
48~66	Reserved	
67	Brake control	This is a dedicated function for winding applications. When the brake is enabled, the output of this function will be valid.
68	Material cutoff detection output	This is a dedicated function for winding applications. In case of material cutoff, the output of this function will be valid.
69	FDT1 lower limit (pulse)	This is similar to #3/4 function. The difference is that the output will be valid when the frequency is lower than the “setting-hysteresis” and automatically turn invalid after some time. If the single pulse output is set, the time will be set by F03.17 to F03.20; and if the level output is enabled, the time is 0.1 s by default.
70	FDT2 lower limit (pulse)	
71	FDT1 lower limit (pulse, invalid in JOG)	This function is the same as #69/70 function, except for no output in the JOG status.
72	FDT2 lower limit (pulse, invalid in JOG)	
73	Output overcurrent	When this function of the output terminal is enabled, the current exceeds the F15.66 overcurrent detection level, and the duration reaches the value of F15.67, the output will be valid.

The Y1 multi-function output ports are of open collector output type, with YCM as the common output port. If the selected function is disabled, the electronic switch will be OFF, and the multi-function output ports will be in the invalid status. If the selected function is enabled, the electronic switch will be ON, and the multi-function output ports will be in the valid status. The open collector can be powered on internally or by an external power supply (12-30V).

The relay output is from the internal relay of the inverter. The relay has one set of normally open contacts and one set of normally closed contacts. When the selected function is disabled, the EB-EC is normally closed and EA-EC is normally open. When the selected function is engaged, the internal relay coil will be powered on, the EB-EC will be disconnected, and the EA-EC will be engaged. See Fig. 7- 12.

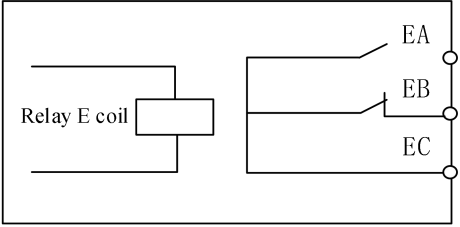

Fig. 7- 12 Relay Contacts

Function code	Function code name	Parameter description								Unit	Default setting	Attribute	Mailing address
		D7	D6	D5	D4	D3	D2	D1	D0				
F03.05	Options of output signal type	*	*	*	*	*	R1	*	Y1		0*0	○	0x0305
		0: level 1: single pulse											

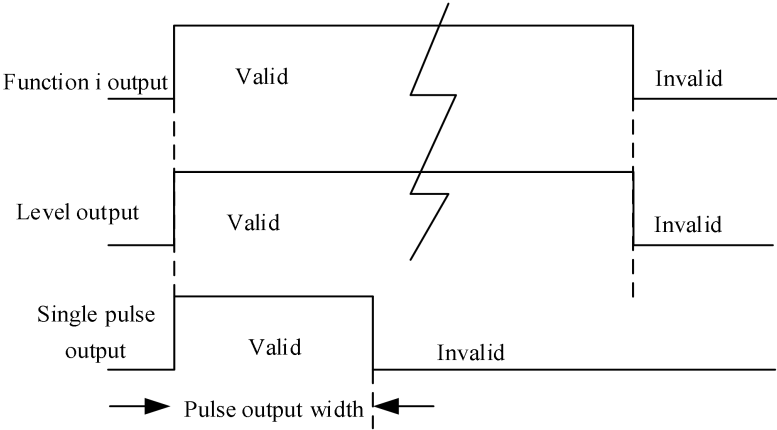

Fig. 7- 13 Schematic Diagram of Level and Single Pulse Output of Digital Output Terminal

The digital output terminal Y1 and relay output terminal R1 have two output types: level

and single pulse, as shown in Fig. 7-13. For the level output, the output status of the function terminal is consistent with the function status; and for the single pulse output, the active level of a certain pulse width will not be outputted until the function is enabled.

This function code is subject to bit operation. For specific settings, refer to the description of the function code F02.15. Table 7-7

Function code	Function code name	Parameter description								Unit	Default setting	Attribute	Mailing address
F03.06	Positive/negative logic of digital output	D7	D6	D5	D4	D3	D2	D1	D0		0*0	○	0x0306
		*	*	*	*	*	R1	*	Y1				
		0: positive logic is valid in the closed state/invalid in the open state 1: negative logic is valid in the closed state/invalid in the open state											

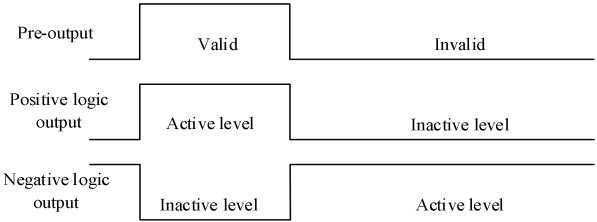

Fig. 7-14 Schematic Diagram of Positive & Negative Logic Output of Digital Output Terminal

The multi-function digital output terminal has two output logics according to the design:

0: Positive logic. When the function is enabled, the multi-function output terminal will output the active level; otherwise, the multi-function output terminal will output the inactive level.

1: Negative logic. When the function is enabled, the multi-function output terminal will output the inactive level; otherwise, the multi-function output terminal will output the active level.

This function code is subject to bit operation. For specific settings, refer to the description of the function code F02.15. Table 7-7

- ★ This function is for logic matching with other external devices.  
Active level: Y1, low level by default; R1, high level by default.



Function code	Function code name	Parameter description								Unit	Default setting	Attribute	Mailing address
F03.08	Output status control in jog	D7	D6	D5	D4	D3	D2	D1	D0		00000	○	0x0308
		*	*	*	REV	FDT 2	FDT 1	FAR	RUN				
		0: valid in jogging 1: invalid in jogging											

It is usually not necessary for DO to output certain statuses during jog running. The corresponding output can be shielded by setting the corresponding bit of this function code to 1. If F03.08=xxx1x is set and the FAR output is valid, the actually selected output terminal will not output the active level.

This function code is subject to bit operation. For specific settings, refer to the description of the function code F02.15. Table 7-7

Function code	Function code name	Parameter description	Unit	Default setting	Attribute
F03.09	Y1 valid delay time	0.000~30.000	s	0.000	●
F03.10	Y1 invalid delay time	0.000~30.000	s	0.000	●
F03.13	R1 valid delay time	0.000~30.000	s	0.000	●
F03.14	R1 invalid delay time	0.000~30.000	s	0.000	●

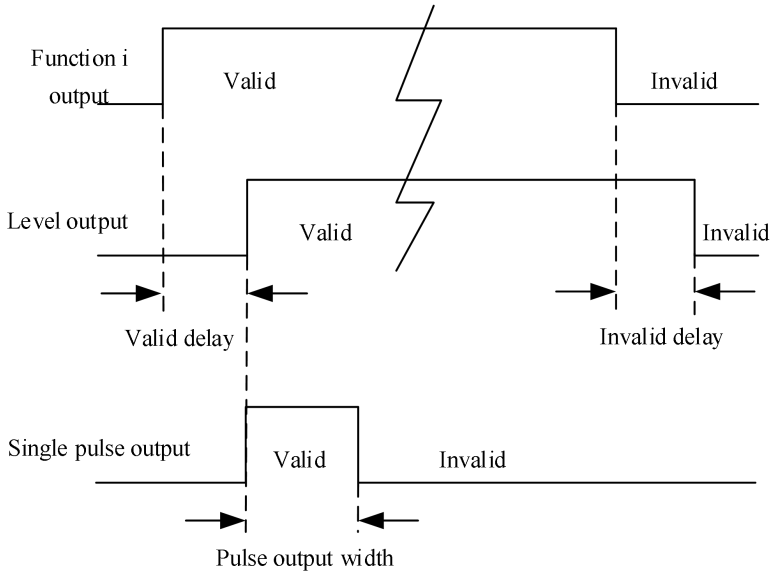

Fig. 7- 15 Schematic Diagram of Level and Single Pulse Output of Digital Output Terminal

When the status of the selected function changes, the corresponding output terminal will make a response with delay based on the function code settings. At present, the terminals Y1 and R1 support this function. Details under default conditions: When the function changes from the invalid to valid status and is maintained with the valid delay, the corresponding output terminal will output the active level. When the function changes from the valid to invalid status and is maintained with the invalid delay, the corresponding output terminal will output the inactive level.

★ If the function code is set to 0.000s, the delay will be invalid.

Function code	Function code name	Parameter description	Unit	Default setting	Attribute	Mailing address
F03.17	Single pulse time of Y1 output	0.001 ~ 30.000	s	0.250	●	0x0311
F03.19	Single pulse time of R1 output	0.001 ~ 30.000	s	0.250	●	0x0312

When one function output terminal is in the single pulse output mode (see F03.05 for details), the pulse width of the active level can be controlled by setting the single pulse output time, in order to meet different process or control requirements.

Function code	Function code name	Parameter description	Unit	Default setting	Attribute	Mailing address
F03.21	Options of analog output M1	See Table 7-9 Function List of Multi-function Analog Output Terminal		0	○	0x0315

M1 is a multi-function analog output terminal. Its functions can be defined separately by setting the value of the function code F03.21.

For example, if F03.21=0 is defined, the function of the M1 terminal is to output the “operating frequency (absolute value)”. The current |operating frequency| is reflected by the output voltage. If the operating frequency increases from 0.00Hz to 50.00Hz (assuming F00.16=50.00), the voltage of the M1 output port will increase from 0.00V to 10.00V under the default conditions, showing the same change trend. Specific options are described in Table 7-9.

Table 7-9 Function List of Multi-function Analog Output Terminal

Settings	Function	Description
0	Operating frequency (absolute value)	0.00Hz to Fmax, corresponding to the output 0.0% to 100.0%
1	Set frequency (absolute value)	0.00Hz to Fmax, corresponding to the output 0.0% to 100.0%
2	Output torque (absolute value)	0.0% to 200.0%, corresponding to the output 0.0% to 100.0%
3	Set torque (absolute value)	0.0% to 200.0%, corresponding to the output 0.0% to 100.0%
4	Output current	0.0A to 2*Ie, corresponding to the output 0.0% to 100.0%
5	Output voltage	0V to 1.5*Ue, corresponding to the output 0.0% to 100.0%
6	Bus voltage	0V to about 2.63*Ue, corresponding to the output 0.0% to 100.0% (That is, for the 220V driver, 579V corresponds to the output 100.0%; and for the 380V driver, 1000V corresponds to the output 100.0%. Drivers at different voltage levels have the same output voltage at their rated voltages.)
7	Output power	0.00kW to 2*Pe, corresponding to the output 0.0% to 100.0%
8	All	Output the actual input voltage, instead of the offset

9	AI2	result. 0.0% to 100.0%, corresponding to the output 0.0% to 100.0%
12	High-frequency pulse input (with 100% corresponding to 100.00kHz)	The function codes F02.26-F02.28 correspond to the output 0.0%-100.0%.
13	Communication setting 1	Communication setting by M1 terminal, communication address option 701AH
14	Count value	0 to F16.03, corresponding to the output F16.10 to F16.11
15	Length value	0 to F16.01, corresponding to the output F16.10 to F16.11
16	PID output percentage	-100.0% to 100.0%, corresponding to the output 0.0% to 100.0%
18	PID feedback	-100.0% to 100.0%, corresponding to the output 0.0% to 100.0%
19	PID setting	-100.0% to 100.0%, corresponding to the output 0.0% to 100.0%

★ Fmax, maximum frequency (F00.16)

Ie, rated current of the inverter (F12.21)

Ue, rated voltage of the inverter (F12.20)

Pe, rated power of the inverter (F12.19)

The output physical quantity of the analog output terminal can be switched between the voltage signal (0.00V to 10.00V) and current signal (0.00mA to 20.00mA) via the jumper cap. For the voltage signal output, the value from 0.0% to 100.0% corresponds to the output 0.00V to 10.00V. For the current signal output, the value from 0.0% to 100.0% corresponds to the output 0.00mA to 20.00mA.

Function code	Function code name	Parameter description	Unit	Default setting	Attribute	Mailing address
F03.27	M1 output bias	-100.0 ~ 100.0	%	0.0	●	0x031B
F03.28	M1 output gain	-10.00 ~ 10.00		1.00	●	0x031C

The above function codes are usually used to correct the zero drift of analog output and the deviation of output amplitude. They can also be used to customize the required AO output curve to meet the requirements of different instruments or others. If the offset is represented by “b”, the gain by “k”, actual output by “Y” , standard output by “X”, the actual output is:  $Y=kX+b$ .



1. In order to meet the needs of different instruments or external devices, the full-scale voltage of M1 is actually 10.9V and the full-scale current is actually 22mA.
2. The default setting of M1 is 0.00-10.00V.
3. Where there are high precision requirements for the analog output during operation, test the no-load outputs of the terminals M1 with a multimeter first.

Function code	Function code name	Parameter description								Unit	Default setting	Attribute	Mailing address
F03.31	Control logic options of PLC output terminal	D7	D6	D5	D4	D3	D2	D1	D0		00 000	●	0x031F
		*	*	*	*	*	R1	*	Y1				
		0: no output 1: output											

When the output functions of Y1 and R1 are set to “47: PLC output”, the output result will be controlled by the corresponding bit of F03.31. 0 indicates no output and 1 indicates that there is output.

Function code	Function code name	Parameter description	Unit	Default setting	Attribute	Mailing address
F03.34	Output type options of analog output M1	0: 0~10V 1: 4~20mA 2: 0~20mA		0	○	0x0322

The output type of M1 is controlled by F03.34, and the corresponding short-circuit cap of the control panel M1 needs to be set correctly according to the output voltage or current:

F03.34=0: output voltage 0~10V

F03.34=1: output current 4~20mA

F03.34=2: output current 0~20mA

## 7.5 Start/Stop Control Parameter Group of F04 Group

Function code	Function code name	Parameter description	Unit	Default setting	Attribute	Mailing address
F04.00	Start-up method	0: direct start 1: start of speed tracking		0	○	0x0400

### F04.00=0: direct start

The inverter is started at the starting frequency, following the DC braking (not suitable when F04.04=0) and pre-excitation (not suitable when F04.07=0). The starting frequency will change to the set frequency after the holding time.

**F04.00=1: start with speed tracking**

The inverter is smoothly started from the current rotation frequency of the motor, following the speed tracking (size and direction).

Function code	Function code name	Parameter description	Unit	Default setting	Attribute	Mailing address
F04.01	Start frequency	0.00 ~ 10.00	Hz	0.00	○	0x0401
F04.02	Start frequency hold time	0.00 ~ 60.00, 0.00 is invalid	s	0.00	○	0x0402

In order to ensure the motor torque during the start, please set the appropriate starting frequency. To fully establish the magnetic flux during the motor start, the starting frequency should be maintained for some time. The starting frequency F04.01 is not limited by the lower frequency limit.

Function code	Function code name	Parameter description	Unit	Default setting	Attribute	Mailing address
F04.03	Starting current of DC braking	0.0 ~ 100.0 (100.0 = Rated current of motor)	%	100.0	○	0x0403
F04.04	Starting time of DC braking	0.00 ~ 30.00	s	0.00	○	0x0404

Before the inverter is started, the motor may be in the status of low-speed running or reverse rotation. If the inverter is started immediately, it may be subject to overcurrent protection. In order to avoid such protections, it is necessary to perform DC braking to stop the motor and then make the motor run in the set direction to the set frequency before the inverter is started.

When F04.03 is set to different values, DC braking torques can be enabled.

F04.04 is used to set the time to enable DC braking. The inverter will start running once the set time is up. If F04.04=0.00, DC braking is invalid during start.

★ DC braking is started as shown in Fig. 7-17.



When multiple motors are driven by a single inverter, this function can be applied.

Function code	Function code name	Parameter description	Unit	Default setting	Attribute	Mailing address
F04.06	Pre-excitation current	50.0 ~ 500.0 (100.0 = no-load current)	%	100.0	○	0x0406
F04.07	Pre-excitation time	0.00 ~ 10.00	s	0.10	○	0x0407

The inverter will start running after the magnetic field is established according to the set pre-excitation current F04.06 and the set pre-excitation time F04.07 is up. If the pre-excitation time is set to 0, the inverter will be started directly without pre-excitation.

The pre-excitation current F04.06 is the percentage relative to the rated no-load current of the motor.

Function code	Function code name	Parameter description	Unit	Default setting	Attribute	Mailing address
F04.08	Speed tracking mode	Ones place: Tracking start frequency 0: maximum frequency 1: stop frequency 2: power frequency Tens place: Selection of search direction 0: search only in command direction 1: search in the opposite direction if the speed cannot be found in the command direction		0	○	0x0408

When the speed tracking start mode (F04.00=1) is selected, the inverter will be subject to speed tracking according to the setting of F04.08 during the start. For quicker tracking to the current operating frequency of the motor, please select the appropriate mode based on the working conditions.

If the units place of F04.08 is 0, tracking will be performed from the maximum frequency. This can be applied when the operating conditions of the motor are completely uncertain (for example, the motor is already rotating when the inverter is powered on).

If the units place of F04.08 is 1, tracking will be performed from the stop frequency. This mode is usually applied.

If the units place of F04.08 is 2, tracking will be performed from the power frequency. This mode can be applied during switching from the power frequency.

If the tens place of F04.08 is 0, search will be performed only in the command direction after speed tracking is enabled. In case that the corresponding speed is not found, the inverter will start running from the zero speed.

If the tens place of F04.08 is 1, search will be performed first in the command direction after speed tracking is enabled and then in the opposite direction if no speed is found.

Function code	Function code name	Parameter description	Unit	Default setting	Attribute	Mailing address
F04.10	Deceleration time of speed tracking	0.1 ~ 20.0	s	2.0	○	0x040A
F04.11	Speed tracking current	30.0~150.0 (100.0 = rated current of inverter)	%	50.0	○	0x040B
F04.12	Speed tracking compensation gain	0.00 ~ 10.00		1.00	○	0x040C

**F04.10:** scanning speed for speed tracking from the predetermined frequency. The duration is the time for the rated frequency to decrease to 0.00Hz.

**F04.11:** current tracking, ratio to the rated current of the inverter. The lower the current, the less the impact on the motor is, and the higher the tracking accuracy is. If the set value is too small, the tracking result may be inaccurate, causing failure in start. The higher the current, the less the motor speed drops. This value should be increased during heavy-load tracking.

**F04.12:** tracking intensity, usually taking the default value. When the tracking speed is high and the overvoltage protection is enabled, you can try to increase this value.

Function code	Function code name	Parameter description	Unit	Default setting	Attribute	Mailing address
F04.14	Acceleration and deceleration mode	0: linear acceleration and deceleration 1: acceleration and deceleration of continuous S curve 2: acceleration and deceleration of intermittent S curve		0	○	0x040E
F04.15	Starting time of S curve in acceleration	0.00 to system acceleration time/2 (F15.13=0) 0.0 to system acceleration time/2 (F15.13=1) 0 to system acceleration time/2 (F15.13=2)	s	1.00	●	0x040F
F04.16	Ending time of S curve in acceleration	0.00 to system acceleration time/2 (F15.13=0) 0.0 to system acceleration time/2 (F15.13=1) 0 to system acceleration time/2 (F15.13=2)	s	1.00	●	0x0410



F04.17	Starting time of S curve in deceleration	0.00 to system deceleration time/2 (F15.13=0) 0.0 to system deceleration time/2 (F15.13=1) 0 to system deceleration time/2 (F15.13=2)	s	1.00	●	0x0411
F04.18	Ending time of S curve in deceleration	0.00 to system deceleration time/2 (F15.13=0) 0.0 to system deceleration time/2 (F15.13=1) 0 to system deceleration time/2 (F15.13=2)	s	1.00	●	0x0412

**F04.14=0: linear acceleration and deceleration**

The output frequency increases or decreases linearly. The acceleration and deceleration time is set by the function codes F00.14 and F00.15 by default.

**F04.14=1: continuous S-curve acceleration and deceleration**

The output frequency increases or decreases according to the curve. The S curve is usually where there are relatively low requirements for start and stop, such as elevators and conveyor belts. In the acceleration process shown in Fig. 7-16, t1 is the set value of F04.15, and t2 is the set value of F04.16. In the deceleration process, t3 is the set value of F04.17, and t4 is the set value of F04.18. The slope of the output frequency remains unchanged between t1 and t2 as well as between t3 and t4.

**F04.14=2: intermittent S-curve acceleration and deceleration**

Compared with the continuous S-curve, the intermittent S-curve will not be over-tuned. The current S-curve trend will be stopped immediately according to changes in the settings and acceleration/deceleration time, and the new planned S-curve trend will be applied.

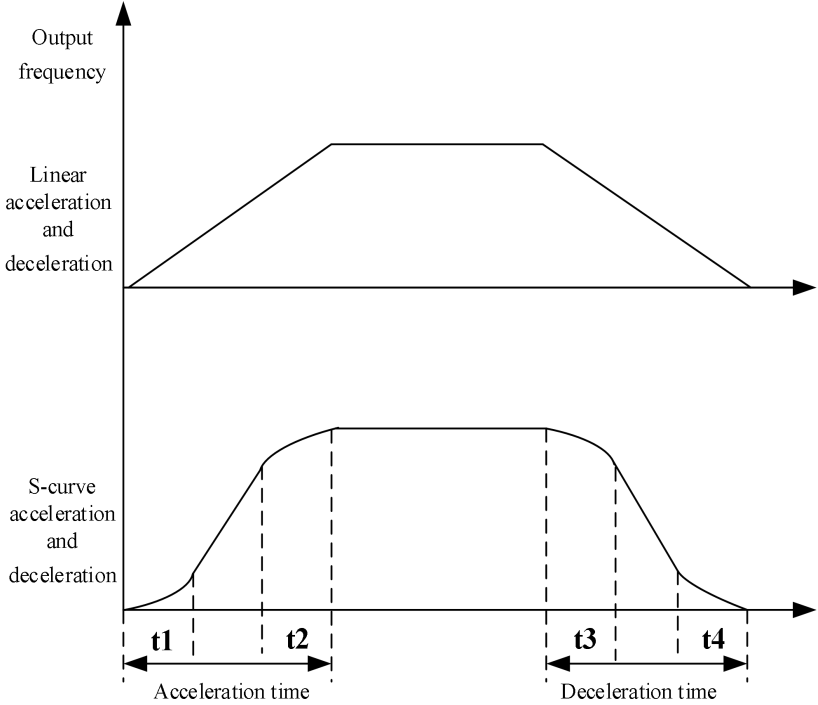

Fig. 7-16 Acceleration/Deceleration Time Control Diagram

Function code	Function code name	Parameter description	Unit	Default setting	Attribute	Mailing address
F04.19	Stop mode	0: slow down to stop 1: free stop		0	○	0x0413

**F04.19=0: deceleration to stop**

The motor decelerates to stop according to the set deceleration time [default setting: based on F00.15 (deceleration time 1)].

**F04.19=1: free stop**

When the stop command is valid, the inverter will stop output immediately, and the motor will freely coast to stop. The stop time depends on the inertia of the motor and load.

If the free stop terminal has been set and enabled, the inverter will be immediately in the free stop status. Even if this terminal is disabled, the inverter will not restart running. Instead, the running command must be entered again to start the inverter.

Function code	Function code name	Parameter description	Unit	Default setting	Attribute	Mailing address
F04.20	Starting frequency of DC braking in stop	0.00 to maximum frequency F00.16	Hz	0.00	○	0x0414
F04.21	DC braking current in stop	0.0 to 150.0 (100.0 = rated current of motor)	%	100.0	○	0x0415
F04.22	DC braking time in stop	0.00~30.00 0.00: invalid	s	0.00	○	0x0416
F04.23	Demagnetization time for DC braking in stop	0.00~30.00	s	0.50	○	0x0417

**F04.20:** Set the starting frequency of DC braking in deceleration to stop. Once the output frequency is less than the set frequency during deceleration stop, and the time of DC braking for stop is not 0, DC braking for stop will be enabled.

**F04.21:** Set different values to apply the torques of DC braking for stop.

**F04.22:** Set the duration of DC braking for stop. If F04.22=0.00, DC braking for stop will be invalid. When an external terminal sends a signal of DC braking for stop, the duration of DC braking for stop will be larger of the valid time of the signal of DC braking for stop from the external terminal and the set time of F04.22.

**F04.23:** When the output frequency reaches the set value of F04.20 during deceleration to stop, and the set time of F04.23 is up, DC braking will be enabled.

The process of DC braking for stop is shown in Fig. 7-18.

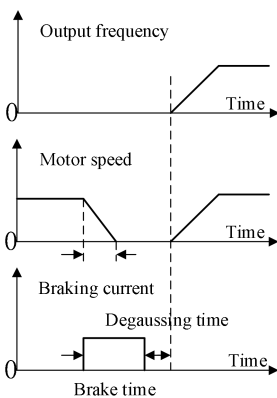

Fig. 7-17 DC Braking Process for Start

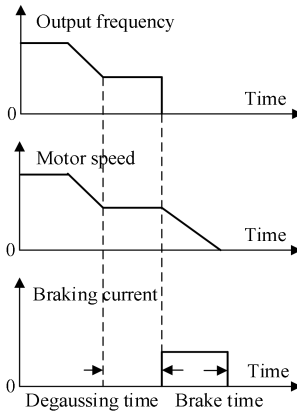

Fig. 7-18 DC Braking Process for Stop



In the presence of heavy loads, the motor cannot be stopped completely through normal deceleration due to inertia. You can extend the duration of DC braking for stop or increase the current of DC braking for stop to stop the motor from rotating.

Function code	Function code name	Parameter description	Unit	Leave-factory value	Attribute	Mailing address
F04.24	Flux braking gain	100~150 (100: no flux braking)		100	○	0x0418

When the magnetic flux braking is valid (F04.24>100), the motor can be quickly slowed down by increasing its magnetic flux, and the electric energy can be converted into thermal energy during motor braking.

Flux braking may lead to quick deceleration, but the output current may be high. The flux braking intensity (F04.24) can be set restriction and protection to avoid damage to the motor. If flux braking is not applied, the deceleration time will be extended but the output current will be low.

Function code	Function code name	Parameter description	Unit	Default setting	Attribute	Mailing address
F04.26	Start mode after protection/free stop	0: start according to F04.00 setting mode 1: start of speed tracking		0	○	0x041A

The start after the protection or free stop may be enabled by default according to the F04.00 setting (F04.26=0), or set to the speed tracking start (F04.26=1). For the stop mode, see the description of the function code F04.00.

Function code	Function code name	Parameter description	Unit	Default setting	Attribute	Mailing address
F04.27	Second confirmation of terminal start command	0: not required for confirmation 1: to be confirmed 2: not required for mode 2 (also not required during fault reset)		0	○	0x041B

**F04.27=0:** not confirmed

The running terminal (RUN or F/R) is closed, F00.03 is set to 0 or 1, and the terminal is powered on during start/stop or directly run once enabled by switching the start/stop mode.

**F04.27=1:** confirmed

The running terminal is closed, F00.03 is set to 0 or 1, and the terminal is powered on during start/stop or cannot directly run once enabled by switching the start/stop mode. It is necessary to first disconnect the running terminal and then close it to start running.

**F04.27=2:**

Function code	Function code name	Parameter description	Unit	Default setting	Attribute	Mailing address
F04.29	Zero speed check frequency	0.00 ~ 5.00	Hz	0.25	●	0x041C

When the output frequency is lower than the zero speed judgment frequency, the terminal “zero-speed running” will be valid.

Function code	Function code name	Parameter description	Unit	Default setting	Attribute	Mailing address
F04.30	Initial position search after power-on or protection	0: invalid 1: valid		1	●	0x041D

When the synchronous motor is used (e.g. F01.00=2) and subjected to VF control, the initial angle is essential for the control performance. In particular, reversing may occur at the moment of start. Thus, the initial position is searched by default after power-on or protection, in order to achieve a better control performance.

**7.6 VF Control Parameter Group of F05 Group**

The function codes in this group are valid for V/F control and invalid for vector control.

V/F control is suitable for general-purpose loads such as fans and pumps, or when multiple motors are driven by one inverter or the power of the inverter is quite different from that of the motor.

Function code	Function code name	Parameter description	Unit	Default setting	Attribute	Mailing address
F05.00	V/F curve setting	0: straight line V/F 1: multi-point broken line V/F 2: 1.3-power V/F 3: 1.7-power V/F 4: square V/F 5: VF complete separation mode (Ud = 0, Uq = K * t = voltage of separation voltage source)		0	○	0x0500

		6: VF semi-separation mode ( $U_d = 0$ , $U_q = K * t = F/Fe * 2 * \text{voltage of separation voltage source}$ )				
--	--	--	--	--	--	--

**F05.00=0: linear V/F**

It is suitable for ordinary constant-torque loads.

**F05.00=1: multi-point V/F**

It is suitable for special loads such as dehydrators, centrifuges and cranes. Any V/F relationship curve can be obtained by setting the parameters F05.01 to F05.06.

**F05.00=2/3: 1.3<sup>th</sup> power/1.7<sup>th</sup> power of V/F**

It is a VF curve between the linear VF and square VF.

**F05.00=4: square V/F**

It is suitable for centrifugal loads such as fans and pumps.

**F05.00=5: VF complete separation mode**

In this case, the output frequency and output voltage of the inverter are independent of each other. The output frequency depends on the frequency source, and the output voltage is determined by F05.07 (VF separation voltage source).

The VF complete separation mode is usually applied in induction heating, inverter power supply, torque motor control, etc.

**F05.00=6: VF semi-separation mode**

In this case, V and F are proportional, but their proportional relationship can be set by the voltage source F05.07. In addition, the relationship between V and F is also related to the rated voltage and rated frequency of the motor in the F1 group.

Assuming that the voltage source input is X (X is 0 to 100%), the relationship between the output voltage V and frequency F of the inverter is:

$$V/F = 2 * X * (\text{rated voltage of the motor}) / (\text{rated frequency of the motor})$$

Function code	Function code name	Parameter description	Unit	Default setting	Attribute	Mailing address
F05.01	Frequency point F1 of multi-point VF	0.00 ~ F05.03	Hz	0.50	●	0x0501
F05.02	Voltage point V1 of multi-point VF	0.0 ~ 100.0 (100.0 = Rated voltage)	%	1.0	●	0x0502
F05.03	Frequency point F2 of multi-point VF	F05.01 ~ F05.05	Hz	2.00	●	0x0503
F05.04	Voltage point V2 of	0.0 ~ 100.0	%	4.0	●	0x0504

	multi-point VF					
F05.05	Frequency point F3 of multi-point VF	F05.03 to rated frequency of motor (reference frequency)	Hz	5.00	●	0x0505
F05.06	Voltage point V3 of multi-point VF	0.0~100.0	%	10.0	●	0x0506

The code parameters F05.01 to F05.06 are valid when the multi-point polyline VF is selected (F05.00=1).

All V/F curves are dependent on the curve set by the percentage of input frequency and the percentage of output voltage, linearized in sections within different input ranges.

The rated frequency of the motor is the final frequency of the V/F curve, and also the frequency corresponding to the highest output voltage. Percentage of the input frequency: rated frequency of the motor = 100.0%; percentage of the output voltage: rated voltage  $U_e$  of the motor = 100.0%.

The relationships of the three voltage points and frequency points must meet the following requirements:  $V1 < V2 < V3$ ,  $F1 < F2 < F3$ ;

 If the slope of the V/F curve is too large, the “overcurrent” protection may be enabled. Particularly, if the low-frequency voltage is too high, the motor may be overheated and even burnt, and the inverter may be subject to overcurrent stall or overcurrent protection.

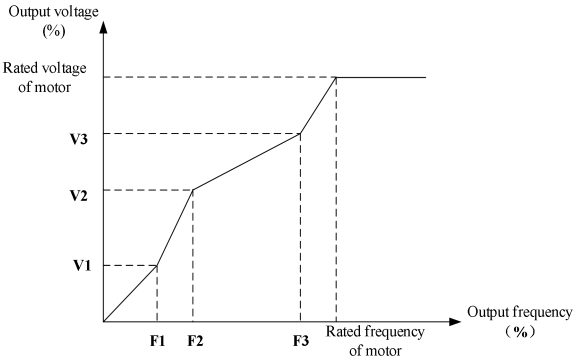

Fig. 7-19 Schematic Diagram of Multi-point Polyline V/F Curve

Function code	Function code name	Parameter description	Unit	Default setting	Attribute	Mailing address
F05.07	Voltage source of VF separation mode	0: digital setting of VF separation voltage		0	○	0x0507

		1: AI1 2: AI2 3: reserved 4: High-frequency pulse (X5) 5: PID 6: communication setting Note: 100% is the rated voltage of the motor.				
F05.08	Digital setting of VF separation voltage	0.0 to 100.0 (100.0=Rated voltage of motor)	%	0.0	●	0x0508

VF separation is usually applied in induction heating, inverter power supply, torque motor control, etc.

When VF separation control is selected, the output voltage can be set by the function code F05.08 or according to the analog, high-speed pulse, PID or communication settings. For non-digital settings, 100% of each setting corresponds to the rated voltage of the motor. When the percentage set by the analog output is negative, the set absolute value will be taken as the valid set value.

**F05.07=0: digital setting of VF separation voltage (F05.08)**

The VF separation output voltage depends on the digital setting of VF separation voltage (F05.08).

**F05.07=1:AI1**

**F05.07=2:AI2**

**F05.07=4: High-frequency pulse (X5)**

The VF separation output voltage depends on AI/HDI (percentage) \* F05.08 (digital setting of VF separation voltage).

For the details of AI1-AI2 and X5, refer to the F00.04 description. They have the same meaning. 100.00% is the percentage to the set value of F05.08 (digital setting of VF separation voltage).

**F05.07=5: process PID**

The VF separation output voltage depends on the process PID function output, as described in 7.10.

**F05.07=6: communication setting**

The VF separation output voltage depends on the communication.

- If the master-slave communication (F10.05=1) is enabled and the inverter works as the



slave (F10.06=0), the VF separation output voltage is “700FH (master-slave communication setting) \* F01.02 or others (rated voltage of the motor) \* F10.08 (slave receiving proportional coefficient)”. The 700FH data range is 0.00% to 100.00%, as detailed in Table 12-31.

- For general communication (F10.05=0), the VF separation output voltage is “7006H (voltage setting of the VF separation mode) \* F05.08 (digital setting of the VF separation voltage)”, and the 7006H data range is 0.00% to 100.00%, as detailed in Table 12-31.

Function code	Function code name	Parameter description	Unit	Default setting	Attribute	Mailing address
F05.09	Rise time of VF separation voltage	0.00 ~ 60.00	s	2.00	●	0x0509

The rise time of VF separation voltage refers to the time for the output voltage to increase from 0 to the rated voltage of the motor.

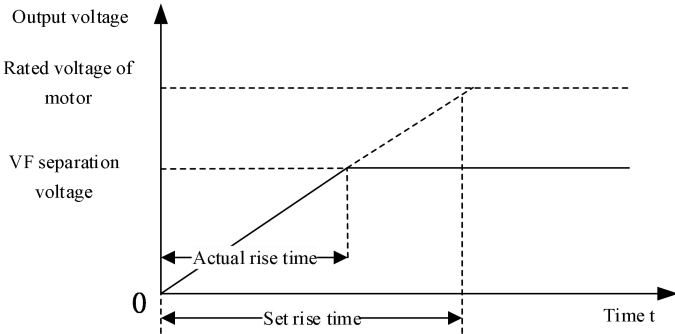

Fig. 7-20 Rise Time Description of VF Separation Voltage

Function code	Function code name	Parameter description	Unit	Default setting	Attribute	Mailing address
F05.10	Compensation gain of V/F stator voltage drop	0.00 ~ 200.00	%	100.00	●	0x050A

It is used to compensate for the voltage drop caused by the stator resistor and wire, and improve the low-frequency load capacity.

Function code	Function code name	Parameter description	Unit	Default setting	Attribute	Mailing address
F05.11	V/F slip compensation gain	0.00 ~ 200.00	%	100.00	●	0x050B

F05.12	V/F slip filtering time	0.00 ~ 10.00	s	1.00	●	0x050C
--------	-------------------------	--------------	---	------	---	--------

As the load increases, the rotor speed of the motor will decrease. To make the rotor speed of the motor close to the synchronous speed under rated load, slip compensation can be enabled. When the motor speed is less than the target value, the set value of F05.11 can be increased.

★: In the case of F05.11=0, slip compensation is invalid. This parameter is valid only for the asynchronous motor.

The slip is 100% during the quick start with large inertia and 0 when the frequency reaches the set value. Quick increase or decrease of the output frequency will cause overvoltage or overcurrent. F05.12 filtering can slow down the rise of voltage and current.

Function code	Function code name	Parameter description	Unit	Default setting	Attribute	Mailing address
F05.13	Oscillation suppression gain	0 ~ 20000		100	●	0x050D
F05.14	Oscillation suppression cutoff frequency	0.00 ~ 600.00	Hz	55.00	●	0x050E

This parameter can be adjusted to suppress motor oscillations during the open loop control (VVF). When the motor does not oscillate, this parameter should not be adjusted as little as possible or properly reduced. If the motor oscillates obviously, this parameter can be increased properly.

Function code	Function code name	Parameter description	Unit	Default setting	Attribute	Mailing address
F05.15	Droop control frequency	0.00 ~ 10.00	Hz	0.00	●	0x050F

This function is usually applied for load distribution when one load is driven by multiple motors.

Droop control is to reduce the output frequency of the inverter with the load increasing, so that the output frequency of the motor drops more in the load driven by multiple motors, thus reducing the load on this motor and leading to even distribution of the load on multiple motors.

This parameter refers to the output frequency drop of the inverter under the rated load.

Function code	Function code name	Parameter description	Unit	Default setting	Attribute	Mailing address
F05.16	Energy saving rate	0.00 ~ 50.00	%	0.00	●	0x0510

F05.17	Energy saving action time	1.00 ~ 60.00	s	5.00	●	0x0511
--------	---------------------------	--------------	---	------	---	--------

The energy saving rate (F05.16) reflects the energy saving capacity. The larger the set value, the more energy will be saved. If the set value is 0.00, energy saving will be invalid.

When energy-saving operation is valid, energy saving control will be enabled once the energy saving conditions are met and have been maintained for the energy saving time (F05.17).

The default settings of the VF control optimization parameters of the synchronous motor are used under normal circumstances.

On the basis of the VF separation voltage source setting, the set value of F05.20 changes at intervals of one minute in the power supply setting.

## 7.7 Vector Control Parameter Group of F06 Group

Function code	Function code name	Parameter description	Unit	Default setting	Attribute	Mailing address
F06.00	Speed proportional gain ASR_P1	0.00 ~ 100.00		12.00	●	0x0600
F06.01	Speed integral time constant ASR_T1	0.000 ~ 30.000, 0.000: no integral	s	0.200	●	0x0601
F06.02	Speed proportional gain ASR_P2	0.00 ~ 100.00		8.00	●	0x0602
F06.03	Speed integral time constant ASR_T2	0.000 ~ 30.000, 0.000: no integral	s	0.300	●	0x0603
F06.04	Switching frequency 1	0.00 to switching frequency 2	Hz	5.00	●	0x0604
F06.05	Switching frequency 2	Switching frequency 1 to maximum frequency F00.16	Hz	10.00	●	0x0605

In the vector control mode, the dynamic speed response of the inverter is adjusted by changing the speed proportional gain (ASR\_P) and speed integral time (ASR\_T) of the speed PI regulator. The increase in ASR\_P or decrease in ASR\_T may accelerate the dynamic response of the speed loop. If ASR\_P is too large or ASR\_T is too small, however, the system may be over-tuned to cause oscillation.

Users should adjust the above speed PI parameters according to the actual load characteristics. Generally, as long as the system does not oscillate, ASR\_P should be increased as much as possible, and then ASR\_T should be adjusted, so that the system makes response fast, without excessive over-tuning.

To enable fast dynamic responses of the system at low and high speeds, PI regulation

should be performed separately at low and high speeds. During the actual operation, the speed regulator will automatically calculate the current PI parameters based on the current frequency. The speed PI parameters are P1 and T1 at the switching frequency 1, and P2 and T2 at the switching frequency 2. If the frequency is greater than the F06.04 switching frequency 1 and less than F06.05 switching frequency 2, the switching frequency 1 and switching frequency 2 will be subject to linear transition. See Fig. 7-21.

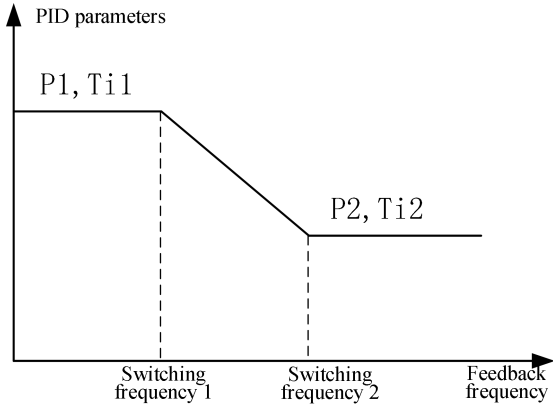

Fig. 7-21 Schematic Diagram of PI Parameters

- i

1. The parameters F06.00 to F06.05 need to be adjusted carefully. They should not be adjusted under normal circumstances.
  2. While setting the switching frequency, note that the F06.04 switching frequency 1 must be less than or equal to the F06.05 switching frequency 2.

Function code	Function code name	Parameter description	Unit	Default setting	Attribute	Mailing address
F06.07	Filtering time constant of speed loop output	0.000 ~ 0.100	s	0.001	●	0x0607

Speed loop output filtering can reduce the impact on the current loop, but the value of F06.07 should not be too large. Otherwise, slow responses may be caused. Use the default settings under normal circumstances.

Function code	Function code name	Parameter description	Unit	Default setting	Attribute	Mailing address
---------------	--------------------	-----------------------	------	-----------------	-----------	-----------------

F06.08	Vector control slip gain	50.00~200.00	%	100.00	●	0x0608
--------	--------------------------	--------------	---	--------	---	--------

As the load increases, the rotor speed of the motor will increase. To make the rotor speed close to the synchronous speed under the rated load, slip compensation can be enabled. When the motor speed is less than the target value, the set value of F06.08 can be increased.

For the speed sensorless vector control, this parameter can be used to adjust the speed accuracy of the motor. Increase this parameter if the motor speed is low under load, and vice versa.

Function code	Function code name	Parameter description	Unit	Default setting	Attribute	Mailing address
F06.09	Upper limit source selection of speed control torque	0: set by F06.10 and F06.11 1: AI1 2: AI2 5: communication setting (percentage) 6: The larger of AI1 and AI2 7: The smaller of AI1 and AI2		0	○	0x0609
F06.10	Upper limit of speed control motor torque	0.0 ~ 250.0	%	165.0	●	0x060A
F06.11	Upper limit of speed control brake torque	0.0 ~ 250.0	%	165.0	●	0x060B

Vector control is used to set the operating conditions of the torque limit. If the output torque of the inverter is greater than the set upper limit, the torque limit function will be enabled, thus controlling the output torque not to exceed the upper limit of speed control torque.

**F06.09=0: depending on F06.10 and F06.11**

The upper limit of electric torque is F06.10, and that of braking torque is F06.11.

**F06.09=1:AI1**

**F06.09=2:AI2**

The upper torque limit is dependent on AI (percentage) \* F06.10/F06.11.

For the details of AI1 and AI2, refer to the F00.04 description. They have the same meaning. 100.00% is the percentage to the set value of F06.10/F06.11.

**F06.09=5: communication setting**

The upper torque limit depends on the communication.

- If the master-slave communication (F10.05=1) is enabled and the inverter works as the slave (F10.06=0), the upper torque limit is “700FH (master-slave communication setting) \* 250.0% \* F10.08 (slave receiving proportional coefficient)”, and the 700FH data range is 0.00% to 100.00%.
- For the general communication (F10.05=0), the upper torque limit is “7019H (communication setting of the upper torque limit for speed control) \* F06.10/F06.11”, and the 7019H data range is 0.0 to 250.0%.

**F06.09=6: the larger of AI1 and AI2**

The formula for torque upper limit calculation is the same as described above, except that the percentage of AI is the larger of AI1 and AI2.

**F06.09=7: the smaller of AI1 and AI2**

The formula for torque upper limit calculation is the same as described above, except that the percentage of AI is the smaller of AI1 and AI2.

	<ol style="list-style-type: none"> <li>1. This code parameter represents the ratio of the output torque in the torque limit action to the rated output torque of the inverter.</li> <li>2. The user can set the upper torque limit according to the actual needs, to protect the motor or meet the working conditions.</li> <li>3. The electric mode and braking mode are set separately.</li> </ol>
---	--

Function code	Function code name	Parameter description	Unit	Default setting	Attribute	Mailing address
F06.12	Excitation current proportional gain ACR-P1	0.00 ~100.00		0.50	●	0x060C
F06.13	Excitation current integral time constant ACR-T1	0.0.00 ~ 600.00 0.00: no integral	ms	10.00	●	0x060D
F06.14	Torque current proportional gain ACR-P2	0.00~100.00		0.50	●	0x060E
F06.15	Torque current integral time constant ACR-T2	0.0.00 ~ 600.00 0.00: no integral	ms	10.00	●	0x060F

The parameters of the current loop PID regulator directly affect the performance and stability of the system. The user does not need to change the default settings under normal circumstances.

Function code	Function code name	Parameter description	Unit	Default setting	Attribute	Mailing address
F06.17	SVC zero-frequency processing	0: braking 1: not processed 2: seal the tube		2	○	0x0611
F06.18	SVC zero-frequency	50.0~400.0 (100.0 is the	%	100.0	○	0x0612

	braking current	no-load current of the motor)				
--	-----------------	-------------------------------	--	--	--	--

In the case of SVC control (e.g. F00.01=1) and zero-frequency operation, the inverter will work according to the F06.17 setting.

**F06.17=0:** braking by the set current of F06.18 for zero servo operation;

**F06.17=1:** no processing;

**F06.17=2:** the inverter freely stop running with its output blocked.

Function code	Function code name	Parameter description	Unit	Default setting	Attribute	Mailing address
F06.20	Voltage feedforward gain	0 ~ 100	%	0	●	0x0614

In the vector control mode, voltage feedforward adjustment is added to automatically increase the torque, i.e. the compensation for stator voltage drop.

Function code	Function code name	Parameter description	Unit	Default setting	Attribute	Mailing address
F06.21	Flux weakening control options	0: invalid 1: direct calculation 2: automatic adjustment		2	○	0x0615
F06.22	Flux weakening voltage	70.00~100.00	%	100.00	●	0x0616
F06.23	Maximum flux weakening current of synchronous motor	0.0~150.0 (100.0 is the rated current of the motor)	%	100.0	●	0x0617
F06.24	Proportional gain of flux weakening regulator	0.00 ~ 10.00		0.50	●	0x0618
F06.25	Integral time of flux weakening regulator	0.01 ~ 60.00	s	2.00	●	0x0619

The synchronous motor is subject to flux weakening control.

**F06.21 Ones place=0, invalid**

Flux weakening control is not performed. The maximum speed of the motor is related to the bus voltage of the inverter. When the maximum speed of the motor does not meet user requirements, the flux weakening function of the synchronous motor should be enabled to increase the speed.

EM730 has two flux weakening modes: direct calculation and automatic adjustment.

**F06.21 Ones place=1, direct calculation**

In the direct calculation mode, the flux weakening current is calculated according to the target speed and can be adjusted manually via the option 06.22. The lower the flux weakening

current, the lower the total output current will be, but the desired effect of flux weakening may not be achieved.

**F06.21 Ones place=2, automatic adjustment**

In the automatic adjustment, the optimal flux weakening current will be selected automatically, but it may affect the dynamic performance of the system or become unstable.

The speed of flux weakening current adjustment can be changed by setting the proportional gain (F06.24) and integral time (F06.25). However, fast adjustment of the flux weakening current adjustment may cause instability. This does not need to be changed manually under normal circumstances.

Function code	Function code name	Parameter description	Unit	Default setting	Attribute	Mailing address
F06.27	Self-learning gain at initial position	0 ~ 200	%	100	●	0x061B

This parameter is used to determine the amplitude of the high-frequency current injected during the initial position identification. The larger this value, the higher the “squeak” sound will be.

Function code	Function code name	Parameter description	Unit	Default setting	Attribute	Mailing address
F06.28	Frequency of low frequency band of injection current	0.00~100.00 (100.00 is the rated frequency of the motor)	%	10.00	●	0x061C
F06.29	Injection current of low frequency band	0.0~60.0 (100.0 is the rated current of the motor)	%	40.0	●	0x061D
F06.30	Regulator gain of low frequency band of injection current	0.00 ~ 10.00		0.50	●	0x061E
F06.31	Regulator integral time of low frequency band of injection current	0.00 ~ 300.00	ms	10.00	●	0x061F
F06.32	Frequency of high frequency band of injection current	0.00~100.00 (100.00 is the rated frequency of the motor)	%	20.00	●	0x0620
F06.33	Injection current f high frequency band	0.0~30.0 (100.0 is the rated current of the motor)	%	8.0	●	0x0621



F06.34	Regulator gain of high frequency band of injection current	0.00 ~ 10.00		0.50	●	0x0622
F06.35	Regulator integral time of high frequency band of injection current	0.00 ~ 300.00	ms	10.00	●	0x0623

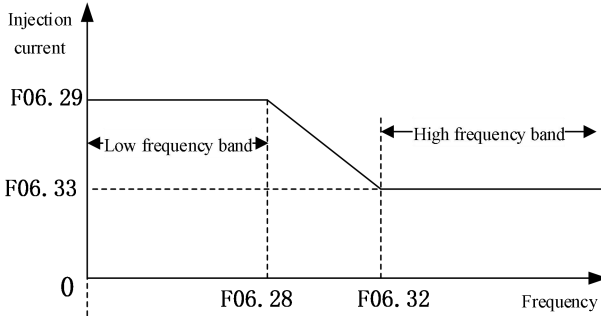

Fig. 7-22 Schematic Diagram of High Frequency Injection

The injection current depends on F06.29 in the low frequency band (output frequency <F06.28) and F06.33 in the high frequency band (output frequency > F06.32).

To get better results, the gain and integral time of the regulator can be adjusted. Default settings can be used under normal circumstances. They must not be adjusted by non-professionals.

Function code	Function code name	Parameter description	Unit	Default setting	Attribute	Mailing address
F06.37	Stiffness coefficient of speed loop	0~20		12	●	0x0625

In the vector control mode, the dynamic speed response of the inverter is adjusted by changing the speed proportional gain (ASR\_P) and speed integral time (ASR\_T) of the speed PI regulator. The increase in ASR\_P or decrease in ASR\_T may accelerate the dynamic response of the speed loop. If ASR\_P is too large or ASR\_T is too small, however, the system may be over-tuned to cause oscillation.

In case of any change in F06.37, the default values of F06.00-F06.03 will change accordingly. The adjustment intensity of the speed PI regulator can be changed. There are 21

optional groups of parameters in total. The larger the set value of F06.37, the larger the proportional gain is, the smaller the integral time is, and the more intense the speed PID regulation is. The smaller the set value of F06.37, the weaker the speed PID regulation is.

Function code	Function code name	Parameter description	Unit	Default setting	Attribute	Mailing address
F06.41	Open-loop low-frequency processing of synchronous motor	0: VF 1: IF 2: IF in start and VF in stop		0	○	0x0629
F06.42	Open-loop low-frequency processing range of synchronous motor	0.0 ~ 50.0	%	8.0	○	0x062A
F06.43	IF injection current	0.0 ~ 600.0	%	80.0	○	0x062B

The default settings of low frequency optimization options of the synchronous motor are suitable for most applications. If a larger torque is required at the low frequency, you can enable the IF mode.

Function code	Function code name	Parameter description	Unit	Default setting	Attribute	Mailing address
F06.46	Speed tracking proportional gain of synchronous motor	0.00 ~ 10.00		1.00	○	0x062E
F06.47	Speed tracking integral gain of synchronous motor	0.00 ~ 10.00		1.00	○	0x062F
F06.48	Filtering time constant of speed tracking of synchronous motor	0.00 ~ 10.00	ms	0.40	○	0x0630
F06.49	Speed tracking control intensity of synchronous motor	1.0 ~ 100.0		5.0	○	0x0631
F06.50	Speed tracking control threshold of synchronous motor	0.00 ~ 10.00		0.20	○	0x0632
F06.51	Injection current (Iq) rise time of synchronous motor	0.010 ~ 1.000	S	5.0	○	0x0633
F06.82	Udc filtering time constant	0 ~ 1500.0	ms	2.0	●	0x0652

Tuning parameters for speed tracking of the synchronous motor.

## 7.8 F07 protection parameter group

Function code	Function code name	Parameter description								Unit	Default setting	Attribute	Mailing address
F07.00	Protection shield	E20	*	E13	E06	*	E04	E07	E08		0*00*0	○	0x0700

		0: valid protection 1: shielded protection		00		
--	--	---	--	----	--	--

Bit setting = 0: when the inverter detects the protection corresponding to this bit, it will stop the output and enter the protection status.

Bit setting = 1: when the inverter detects the protection corresponding to this bit, it will keep the original status without protection.

This code is subject to bit operation. You only need to set the corresponding bit to 0 or 1. As shown in the table below:

Table 7-10 Detailed Definition of Protection Shield Bits

Protection code	E20	*	E13	E06	*	E04	E07	E08
Corresponding bit	7	6	5	4	3	2	1	0
Settings	0/1	*	0/1	0/1	0/1	*	0/1	0/1

For example: To shield the E07 protection, you only need to set the first bit corresponding to E07 to 1, i.e. F07.00=xxx xxx1x.

To shield the E08 and E13 protection, you only need to set the 0<sup>th</sup> bit corresponding to E08 and the 5<sup>th</sup> bit corresponding to E13 to 1. That is, F07.00=xx1 xxxx1.



Unless there are special needs, please do not shield any protection function, so as to prevent the inverter from damage as a result of protection failure.

Function code	Function code name	Parameter description	Unit	Default setting	Attribute	Mailing address
F07.01	Motor overload protection gain	0.20 ~ 10.00		1.00	●	0x0701
F07.02	Motor overload pre-alarm coefficient	50 ~ 100	%	80	●	0x0702

The inverse time curve of motor overload protection is:  $200\% \times (F07.01) \times$  rated current of the motor, sending an alarm of motor overload protection (E13) if the duration reaches one minute;  $150\% \times (F07.01) \times$  rated current of the motor, sending an alarm of motor overload (E13) if the duration reaches 15 minutes.

The user needs to set F07.01 correctly according to the actual overload capacity of the motor. If the set value is too large, the motor may be damaged as a result of overheat but the inverter may not send an alarm!

The F07.02 warning coefficient is used to determine the extent of motor overload for a

protection warning. The larger this value, the less the warning is advanced.

When the cumulative output current of the inverter is greater than the product of the inverse time curve of load by F07.02, the multi-function digital DO terminal of the inverter will output the valid signal “17: Motor overload pre-alarm”.

Function code	Function code name	Parameter description	Unit	Default setting	Attribute	Mailing address
F07.06	Bus voltage control options	Ones place: instantaneous stop/no-stop function options 0: invalid 1: deceleration 2: deceleration to stop Tens place: Overvoltage stall function options 0: invalid 1: valid		2	○	0x0706
F07.07	Voltage of overvoltage stall control	110.0 ~ 150.0 (380V, 100.0 = 537V)	%	131.0 (703V)	○	0x0707

**F07.06=0X: Invalid**

The overvoltage stall is invalid. It is recommended not to set it to 0 in the case of no external braking unit.

The undervoltage stall is also invalid.

When the value in the ones place is 1 or 2, F07.30 is the reference deceleration time.

**F07.06=1X: Valid overvoltage stall**

When the overvoltage stall is valid, the stall control voltage is dependent on F07.07.

The DC bus overvoltage is usually caused by deceleration. Due to the energy feedback during deceleration, the DC bus voltage will rise.

When the DC bus voltage is greater than the overvoltage threshold and the overvoltage stall is valid (F07.06=1X), the deceleration of the inverter will be suspended, the output frequency will remain unchanged, and the energy feedback will be stopped until the DC bus voltage is normal. Then the inverter will restart deceleration. The process of overvoltage stall protection in deceleration is shown in Fig. 7-23.

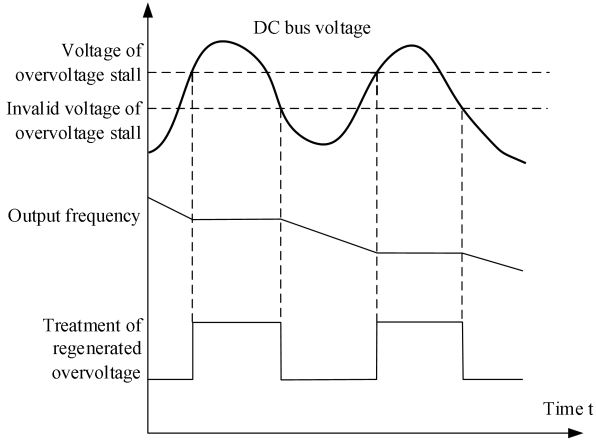

Fig. 7-23 Schematic Diagram of Overvoltage Stall Protection

Function code	Function code name	Parameter description	Unit	Default setting	Attribute	Mailing address
F07.08	Instantaneous stop/no-stop operating voltage	60.0 to instantaneous stop/no-stop recovery voltage (100.0 = standard bus voltage)		76.0	○	0x0708
F07.09	Instantaneous stop/no-stop recovery voltage	Instantaneous stop/no-stop operating voltage to 100.0	%	86.0	●	0x0709
F07.10	Check time for instantaneous stop/no-stop recovery voltage	0.00 ~100.00	s	0.5	●	0x070A
F07.30	Instantaneous stop/no-stop deceleration time	0.00 ~ 300.00	s	20.00	○	0x071E

When the bus voltage is lower than the instantaneous stop/non-stop action voltage (F07.08), the inverter will be in the power-down status. When the bus voltage is higher than the instantaneous stop/non-stop recovery voltage (F07.09), and the judgment time (F07.10) for the instantaneous stop/non-stop recovery voltage is up, the inverter will recover normal operation.

When the ones place of the instantaneous stop/non-stop option of F07.06 bus voltage control is set to “1: Slow down”, as shown in Fig. 7-24: When the bus voltage is lower than the instantaneous stop/non-stop action voltage (F07.08), the inverter will slow down at the speed set based on the deceleration time for the instantaneous stop/non-stop action (F07.30). When the bus

voltage is higher than the instantaneous stop/non-stop recovery voltage (F07.09), the inverter will not slow down. When the cumulative time reaches the judgement time for instantaneous stop/non-stop recovery voltage (F07.10), the inverter will start to acceleration, and the frequency will gradually return to the set value.

When the ones place of the instantaneous stop/non-stop option of F07.06 bus voltage control is set to “2: Slow down to stop”, the action is similar to that of the option 1. When the bus voltage reaches the instantaneous stop/non-stop action voltage, the speed set based on the instantaneous stop/non-stop slowdown time (F07.30) will constantly decrease to 0, regardless of voltage recovery.

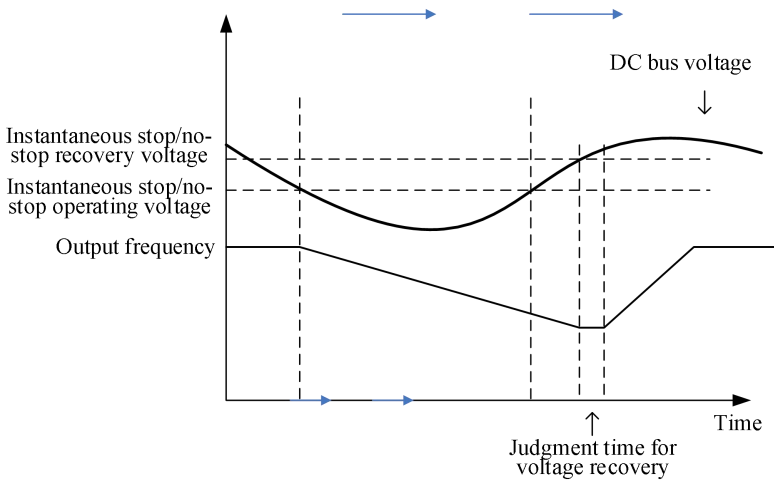

Fig. 7-24 Schematic Diagram of Instantaneous Stop/Non-stop Deceleration Function

Function code	Function code name	Parameter description	Unit	Default setting	Attribute	Mailing address
F07.11	Current limit control	0: invalid 1: limit mode 1 2: limit mode 2		2	○	0x070B
F07.12	Current limit level	20.0 ~180.0 (100% = rated current of inverter)	%	150.0	●	0x070C

**F07.11=0: invalid**

The current limit does not work.

**F07.11=1:** limit mode 1

**F07.11=2:** limit mode 2

When the output current reaches the current limit level (F07.12) and the current limit control is valid (F07.11=1) during operation, the current limit function of the inverter will be enabled. The output frequency will be reduced to limit the increase in output current, thus disabling the overcurrent stall of the inverter. When the output current decreases to below the current limit level, the original running status will be restored. The current limit process is shown in Fig. 7-25.

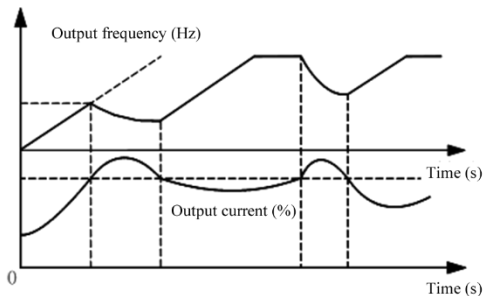



Fig. 7-25 Current Limit Process

F07.12 is used to set the operating conditions of current limit. If the current of the inverter is greater than the set value of this code, the current limit function will be enabled, thus controlling the output current not to exceed the current limit level.

 The current limit is valid only for the V/F drive mode. It is recommended to use this function in the case of large inertia or fan type loads or driving of multiple motors by a single inverter.

Function code	Function code name	Parameter description	Unit	Default setting	Attribute	Mailing address
F07.13	Quick current limit options	0: invalid 1: valid		0	○	0x070D

**F07.13=0: invalid**

The quick current limit does not work.

**F07.13=1: valid**

The quick current limit can reduce overcurrent protections.

Function code	Function code name	Parameter description	Unit	Default setting	Attribute	Mailing address
F07.14	Protection retries	0-20; 0:disable protection retry		0	○	0x070E
F07.15	Options of digital output action in protection retries	0: no action 1: action		0	○	0x070F
F07.16	Interval of protection retries	0.01 ~ 30.00	s	0.50	●	0x0710
F07.17	Restoration time of protection retries	0.01 ~ 30.00	s	10.00	●	0x0711
F07.18	Action option of protection	E07 * E02 E06 E05 E04		0 *0000	○	0x0712
		0: allow protection retry 1: disable protection retry				
F07.32	Action option 2 of protection	E10 E13 E15 E16 * E19 E20 *		000 00000	○	0x0720
		0: allow protection retry 1: disable protection retry				
F07.36	Action option 3 of protection	* * * * * * E09 E17		*****00	○	0x0724
		0: allow protection retry 1: disable protection retry				

The function of protection retry is to prevent the impact of occasional protection on the normal operation of the system. This is valid only for protections of F07.18, F07.32 and F07.36.

If protection retry is enabled, this will be performed after a corresponding protection. That is, the protection will be reset. The protection status depends on F07.15 and the output of the digital output terminal. If a fault is still detected after the protection retry interval, the protection retry will be continued to the set number of protection retries (F07.14) and then the corresponding protection will be reported. If the fault is not detected after several protection retries, the protection retries will be deemed successful and the inverter will continue to run normally.

When protection retries succeed and no trip protection is enabled within the recovery time (F07.17), the number of protection retries will be cleared. When a protection is enabled again,



protection retries will be performed from zero. In case of any trip protection within this period, protection retries will be carried out based on the last count.

Function code	Function code name	Parameter description								Unit	Default setting	Attribute	Mailing address
F07.19	Action option 1 of protection	E21	E16	E15	E14	E13	*	E08	E07		000 00*00	○	0x0713
		0: free stop 1: stop according to stop mode											
F07.20	Action option 2 of protection	E28	E27	*	E23					00*0	○	0x0714	
		0: free stop 1: stop according to stop mode											

With regard to some protections, the action mode of the inverter can be selected via this function code. The inverter will stop running freely when the corresponding bit is set to 0 and according to the stop mode (F04.19) when the corresponding bit is set to 1.

These two function codes are subject to bit operation. You only need to set the corresponding bit to 0 or 1. As shown in the table below:

Table 7-11 Detailed Definition of Protection Action Bits

F07.19	E21	E16	E15	E14	E13	*	E08	E07
F07.20	*	*	*	*	E28	E27	*	E23
Corresponding bit	7	6	5	4	3	2	1	0
Settings	0/1	0/1	0/1	0/1	0/1	0/1	0/1	0/1

For example: To stop the inverter according to the stop mode (F04.19) after the E08 and E13 protection is enabled, you only need to set the 1<sup>st</sup> bit corresponding to E08 and the 3<sup>rd</sup> bit corresponding to E13 to 1. That is, F07.19=xxx x1x1x.

Function code	Function code name	Parameter description	Unit	Default setting	Attribute	Mailing address
F07.21	Options of load loss protection	0: invalid    1: valid		0	●	0x0715
F07.22	Load loss detection level	0.0~100.0	%	20.0	●	0x0716
F07.23	Load loss detection time	0.0~60.0	s	1.0	●	0x0717
F07.24	Options of load loss protection action	0: trip protection, free stop 1: trip protection, stop according to stop mode 2: continue to run, with DO status output		1	○	0x0718

When the off-load protection is valid (F07.21=1), the inverter will be in the running status without DC braking, and the output current is below the off-load detection level (F07.22) and maintained for the off-load detection time (F07.23), the inverter will be in the off-load status.

Specific processing depends on F07.24.

Function code	Function code name	Parameter description	Unit	Default setting	Attribute	Mailing address
F07.27	AVR function	0: invalid 1: valid 2: automatic		1	○	0x071B

**F07.27=0: invalid**

The automatic voltage regulation (AVR) function is invalid.

**F07.27=1: valid**

The AVR function is continuously valid. If the input voltage is lower than the rated input voltage, and the output frequency is greater than the corresponding frequency on the VF curve, the inverter will output the output the maximum voltage to maximize the power output of the motor. If the input voltage is higher than the rated input voltage, the output voltage of the inverter will decrease, and the VF ratio will remain unchanged.

**F07.27=2: automatic**

The AVR function is valid automatically (invalid during deceleration): the inverter will automatically adjust the output voltage according to changes in the actual grid voltage, to keep it at the rated output voltage.

Function code	Function code name	Parameter description	Unit	Default setting	Attribute	Mailing address
F07.28	Stall protection detection time	0.0~6000.0(0.0: no stall protection detection)	s	0.0	○	0x071C
F07.29	Stall control intensity	0 ~ 100	%	100	○	0x071D

When the continuous stall time exceeds the set value of F07.28, the driver will report a stall protection.

In the stall status, the driver will perform automatic control according to the set value of F07.29. The intensity setting depends on the on-site application, instead of maximization.

Function code	Function code name	Parameter description	Unit	Default setting	Attribute	Mailing address
F07.37	Save the initial voltage during power-off	60.0~100.0	%	76.0	○	0x0725
F07.38	Power-on read and judge the voltage	60.0~100.0	%	86.0	○	0x0726
F07.39	Power-on read judgment delay time	0~100.00	S	5.00	○	0x0727

F07.40	Steady-state undervoltage judgment delay time	5~6000	ms	20	○	0x0728
F07.42	Short-circuit the ground to judge the setting value of the current	0.0~100.0	%	20	○	0x072A

### 7.9 Multi-segment Speed and Simple PLC Parameter Group of F08 Group

Function code	Function code name	Parameter description	Unit	Default setting	Attribute	Mailing address
F08.00	Multi-segment speed 1	0.00 to maximum frequency F00.16	Hz	0.00	●	0x0800
F08.01	Multi-segment speed 2	0.00 to maximum frequency F00.16	Hz	5.00	●	0x0801
F08.02	Multi-segment speed 3	0.00 to maximum frequency F00.16	Hz	10.00	●	0x0802
F08.03	Multi-segment speed 4	0.00 to maximum frequency F00.16	Hz	15.00	●	0x0803
F08.04	Multi-segment speed 5	0.00 to maximum frequency F00.16	Hz	20.00	●	0x0804
F08.05	Multi-segment speed 6	0.00 to maximum frequency F00.16	Hz	25.00	●	0x0805
F08.06	Multi-segment speed 7	0.00 to maximum frequency F00.16	Hz	30.00	●	0x0806
F08.07	Multi-segment speed 8	0.00 to maximum frequency F00.16	Hz	35.00	●	0x0807
F08.08	Multi-segment speed 9	0.00 to maximum frequency F00.16	Hz	40.00	●	0x0808
F08.09	Multi- speed 10	0.00 to maximum frequency F00.16	Hz	45.00	●	0x0809
F08.10	Multi-segment speed 11	0.00 to maximum frequency F00.16	Hz	50.00	●	0x080A
F08.11	Multi-segment speed 12	0.00 to maximum frequency F00.16	Hz	50.00	●	0x080B
F08.12	Multi-segment speed 13	0.00 to maximum frequency F00.16	Hz	50.00	●	0x080C
F08.13	Multi-segment speed 14	0.00 to maximum frequency F00.16	Hz	50.00	●	0x080D

F08.14	Multi-segment speed 15	0.00 to maximum frequency F00.16	Hz	50.00	●	0x080E
--------	------------------------	-------------------------------------	----	-------	---	--------

The 16-segment speed can be provided according to the multi-segment speed control terminal, 15-segment frequency command and digital frequency setting F00.07.

Table 7- 12 Combination of Multi-segment Speed Command & Multi-segment Speed Terminal

Segment Speed	Multi-segment speed terminal 4	Multi-segment speed terminal 3	Multi-segment speed terminal 2	Multi-segment speed terminal 1	Selected frequency	Corresponding function code
1	Invalid	Invalid	Invalid	Invalid	Digital frequency setting	Depending on F00.07
2	Invalid	Invalid	Invalid	Valid	Multi-segment speed 1	F08.00
3	Invalid	Invalid	Valid	Invalid	Multi-segment speed 2	F08.01
4	Invalid	Invalid	Valid	Valid	Multi-segment speed 3	F08.02
5	Invalid	Valid	Invalid	Invalid	Multi-segment speed 4	F08.03
6	Invalid	Valid	Invalid	Valid	Multi-segment speed 5	F08.04
7	Invalid	Valid	Valid	Invalid	Multi-segment speed 6	F08.05
8	Invalid	Valid	Valid	Valid	Multi-segment speed 7	F08.06
9	Valid	Invalid	Invalid	Invalid	Multi-segment speed 8	F08.07
10	Valid	Invalid	Invalid	Valid	Multi-segment speed 9	F08.08
11	Valid	Invalid	Valid	Invalid	Multi- speed 10	F08.09
12	Valid	Invalid	Valid	Valid	Multi-segment speed 11	F08.10
13	Valid	Valid	Invalid	Invalid	Multi-segment speed 12	F08.11
14	Valid	Valid	Invalid	Valid	Multi-segment speed 13	F08.12
15	Valid	Valid	Valid	Invalid	Multi-segment	F08.13

					speed 14	
16	Valid	Valid	Valid	Valid	Multi-segment speed 15	F08.14

Precautions for setting:

- ★ The start and stop in multi-segment speed operation depends on the function code F00.02.
- ★ The acceleration/deceleration time in multi-segment speed operation can be controlled by the external terminal with the acceleration/deceleration time function.

The direction of multi-segment speed operation is controlled by the terminals F/R and

RUN.

Function code	Function code name	Parameter description	Unit	Default setting	Attribute	Mailing address
F08.15	Simple PLC running mode	0: stop after a single run 1: stop after a limited number of cycles 2: run at the last segment after a limited number of cycles 3: continuous cycles		0	●	0x080F
F08.16	Limited number of cycles	1 ~ 10000		1	●	0x0810

In addition to the multi-segment speed mode, it also has the simple PLC function. There are four running modes in total, as detailed in Table 7- 13.

Table 7- 13 Details of PLC Running Mode

<b>F08.15</b>	<b>Description</b>
0	The inverter will be stopped after running in the last segment.
1	The inverter will run cyclically and be stopped after the set cycles. The number of cycles depends on the function code F08.16.
2	The inverter will run cyclically and keep the speed of the last segment after running in the last segment, until a stop command is received. The number of cycles depends on the function code F08.16.
3	The inverter will continue cyclic operation until a stop command is received.

- ★ The last segment refers to the segment that is not set to 0, judged from the running time (F08.48) of the 15<sup>th</sup> segment toward the 1<sup>st</sup> segment.

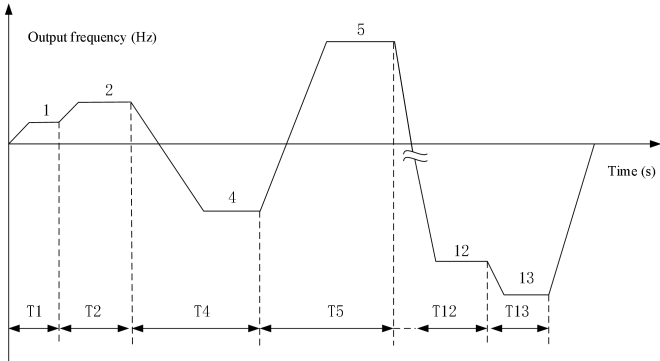

Fig. 7-26 Schematic Diagram of Simple PLC Operation

Fig. 7-26 shows the operation diagram in the running mode “0: stop after a single run”. Since the running time of the 3<sup>rd</sup> segment is set to 0 (F08.24=0.0), the 3<sup>rd</sup> segment will not be put into actual operation. The running time of the 14<sup>th</sup> and 15<sup>th</sup> segments is set to 0 (F08.46=0.0, F08.48=0.0), so the last segment is the 13<sup>th</sup> segment, and the inverter will be stopped after running in the 13<sup>th</sup> segment.

Function code	Function code name	Parameter description	Unit	Default setting	Attribute	Mailing address
F08.17	Simple PLC memory options	<p><b>Ones place:</b> stop memory options                      0: no memory (from the first segment)                      1: memory (from the moment of stop)</p> <p><b>Tens place:</b> power-down memory options                      0: no memory (from the first segment)                      1: memory (from the power-down moment)</p>		00	●	0x0811

The PLC stop memory is to record the current simple PLC running times (F18.10), running stage (F18.11), and running time at the current stage (F18.12). The inverter will continue to run from the memory stage during next operation. If you choose no memory, the PLC process will be performed every time the inverter is started.

The PLC power-down memory is to record the current simple PLC running times (F18.10), running stage (F18.11), and running time at the current stage (F18.12) before the memory is powered off. The inverter will continue to run from the memory stage when the inverter is powered on again. If you choose no memory, the PLC process will be performed every time the inverter is powered on.

Function code	Function code name	Parameter description	Unit	Default setting	Attribute	Mailing address
F08.18	Simple PLC time unit	0: s (second) 1: min (minute)		0	●	0x0812

In order to meet different working conditions, the running time involved in the PLC function is set to a numerical value. Its specific meaning needs to be set in conjunction with the simple PLC time unit (F08.18). At present, there are two types of unit: second and minute.

Function code	Function code name	Parameter description	Unit	Default setting	Attribute	Mailing address
F08.19	Setting of the first segment	<b>Ones place:</b> running direction options 0: forward 1: reverse <b>Tens place:</b> acceleration and deceleration time options 0: acceleration and deceleration time 1 1: acceleration and deceleration time 2 2: acceleration and deceleration time 3 3: acceleration and deceleration time 4		0	●	0x0813
F08.20	Running time of the first segment	0.0 ~ 6000.0	s/min	5.0	●	0x0814
F08.21	Setting of the second segment	<b>Ones place:</b> running direction options 0: forward 1: reverse <b>Tens place:</b> acceleration and deceleration time options 0: acceleration and deceleration time 1		0	●	0x0815

		1: acceleration and deceleration time 2 2: acceleration and deceleration time 3 3: acceleration and deceleration time 4				
F08.22	Running time of the second segment	0.0 ~ 6000.0	s/min	5.0	●	0x0816
F08.23	Setting of the third segment	<b>Ones place:</b> running direction options 0: forward 1: reverse <b>Tens place:</b> acceleration and deceleration time options 0: acceleration and deceleration time 1 1: acceleration and deceleration time 2 2: acceleration and deceleration time 3 3: acceleration and deceleration time 4		0	●	0x0817
F08.24	Running time of the third segment	0.0 ~ 6000.0	s/min	5.0	●	0x0818
F08.25	Setting of the fourth segment	<b>Ones place:</b> running direction options 0: forward 1: reverse <b>Tens place:</b> acceleration and deceleration time options 0: acceleration and deceleration time 1 1: acceleration and deceleration time 2 2: acceleration and deceleration time 3 3: acceleration and deceleration time 4		0	●	0x0819
F08.26	Running time of the fourth segment	0.0 ~ 6000.0	s/min	5.0	●	0x081A
F08.27	Setting of the fifth segment	<b>Ones place:</b> running direction options 0: forward		0	●	0x081B



		<p>1: reverse  <b>Tens place:</b> acceleration and deceleration time options                      0: acceleration and deceleration time 1                      1: acceleration and deceleration time 2                      2: acceleration and deceleration time 3                      3: acceleration and deceleration time 4</p>				
F08.28	Running time of the fifth segment	0.0 ~ 6000.0	s/min	5.0	●	0x081C
F08.29	Setting of the sixth segment	<p><b>Ones place:</b> running direction options                      0: forward                      1: reverse  <b>Tens place:</b> acceleration and deceleration time options                      0: acceleration and deceleration time 1                      1: acceleration and deceleration time 2                      2: acceleration and deceleration time 3                      3: acceleration and deceleration time 4</p>		0	●	0x081D
F08.30	Running time of the sixth segment	0.0 ~ 6000.0	s/min	5.0	●	0x081E
F08.31	Setting of the seventh segment	<p><b>Ones place:</b> running direction options                      0: forward                      1: reverse  <b>Tens place:</b> acceleration and deceleration time options                      0: acceleration and deceleration time 1                      1: acceleration and deceleration time 2                      2: acceleration and deceleration time 3                      3: acceleration and deceleration time 4</p>		0	●	0x081F

F08.32	Running time of the seventh segment	0.0 ~ 6000.0	s/min	5.0	●	0x0820
F08.33	Setting of the eighth segment	<p><b>Ones place:</b> running direction options 0: forward 1: reverse</p> <p><b>Tens place:</b> acceleration and deceleration time options 0: acceleration and deceleration time 1 1: acceleration and deceleration time 2 2: acceleration and deceleration time 3 3: acceleration and deceleration time 4</p>		0	●	0x0821
F08.34	Running time of the eighth segment	0.0 ~ 6000.0	s/min	5.0	●	0x0822
F08.35	Setting of the ninth segment	<p><b>Ones place:</b> running direction options 0: forward 1: reverse</p> <p><b>Tens place:</b> acceleration and deceleration time options 0: acceleration and deceleration time 1 1: acceleration and deceleration time 2 2: acceleration and deceleration time 3 3: acceleration and deceleration time 4</p>		0	●	0x0823
F08.36	Running time of the ninth segment	0.0 ~ 6000.0	s/min	5.0	●	0x0824
F08.37	Setting of the tenth segment	<p><b>Ones place:</b> running direction options 0: forward 1: reverse</p> <p><b>Tens place:</b> acceleration and deceleration time options 0: acceleration and deceleration time 1 1: acceleration and</p>		0	●	0x0825

		deceleration time 2 2: acceleration and deceleration time 3 3: acceleration and deceleration time 4				
F08.38	Running time of the tenth segment	0.0 ~ 6000.0	s/min	5.0	●	0x0826
F08.39	Setting of the eleventh segment	<b>Ones place:</b> running direction options 0: forward 1: reverse <b>Tens place:</b> acceleration and deceleration time options 0: acceleration and deceleration time 1 1: acceleration and deceleration time 2 2: acceleration and deceleration time 3 3: acceleration and deceleration time 4		0	●	0x0827
F08.40	Running time of the eleventh segment	0.0 ~ 6000.0	s/min	5.0	●	0x0828
F08.41	Setting of the twelve segment	<b>Ones place:</b> running direction options 0: forward 1: reverse <b>Tens place:</b> acceleration and deceleration time options 0: acceleration and deceleration time 1 1: acceleration and deceleration time 2 2: acceleration and deceleration time 3 3: acceleration and deceleration time 4		0	●	0x0829
F08.42	Running time of the twelfth segment	0.0 ~ 6000.0	s/min	5.0	●	0x082A
F08.43	Setting of the thirteenth segment	<b>Ones place:</b> running direction options 0: forward 1: reverse		0	●	0x082B

		<p><b>Tens place:</b> acceleration and deceleration time options                      0: acceleration and deceleration time 1                      1: acceleration and deceleration time 2                      2: acceleration and deceleration time 3                      3: acceleration and deceleration time 4</p>				
F08.44	Running time of the thirteenth segment	0.0 ~ 6000.0	s/min	5.0	●	0x082C
F08.45	Setting of the fourteenth segment	<p><b>Ones place:</b> running direction options                      0: forward                      1: reverse  <b>Tens place:</b> acceleration and deceleration time options                      0: acceleration and deceleration time 1                      1: acceleration and deceleration time 2                      2: acceleration and deceleration time 3                      3: acceleration and deceleration time 4</p>		0	●	0x082D
F08.46	Running time of the fourteenth segment	0.0 ~ 6000.0	s/min	5.0	●	0x082E
F08.47	Setting of the fifteenth segment	<p><b>Ones place:</b> running direction options                      0: forward                      1: reverse  <b>Tens place:</b> acceleration and deceleration time options                      0: acceleration and deceleration time 1                      1: acceleration and deceleration time 2                      2: acceleration and deceleration time 3                      3: acceleration and deceleration time 4</p>		0	●	0x082F
F08.48	Running time of the	0.0 ~ 6000.0	s/min	5.0	●	0x0830

fifteenth segment					
-------------------	--	--	--	--	--

When the simple PLC is running, the operating frequency, operating direction, acceleration/deceleration time and operating time in the entire segment can be set separately. This is described below with the 13<sup>th</sup> segment (the last segment) as an example.

**F08.12=50.00:** the operating frequency of 13<sup>th</sup> segment is 50.00Hz.

**F08.43=31:** the operating direction in the 13<sup>th</sup> segment is reverse, and the acceleration and deceleration are controlled based on the acceleration and deceleration time 4 (F15.07/F15.08).

**F08.44=5.0:** the operating time in the 13<sup>th</sup> segment is 5.0s (F08.18=0 by default).

### 7.10 PID Function Parameter Group of F09 Group

The EM730 series inverter has a process PID function, as described in this section. Process PID control is mainly for pressure control, flow control and temperature control.

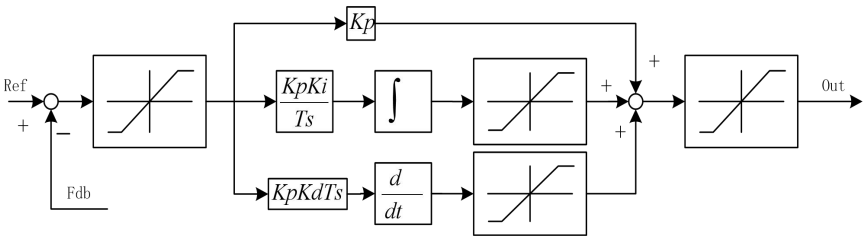

Fig. 7-27 Block Diagram of Process PID

PID control is a kind of closed-loop control. The output signal (Out) of the object controlled by the system is fed back to the PID controller, and the output of the controller is adjusted after PID operation, thus forming one or more closed loops. This function is to make the output value (Out) of the object controlled by the system consistent with the set target value (Ref). The specific block diagram is shown in Fig. 7-27.

The PID controller is used for control by calculating the control quantity with three calculation factors, i.e. proportion (P), integral (I) and differential (D), according to the difference between the set target (Ref) and feedback signal (Fdb). The features of each calculation factor are as follows:

**Proportion (P):**

Proportional control is one of the simplest control modes. The output of the controller is proportional to the input error signal. When only proportional control is enabled, there are

steady-state errors in the system output.

**Integral (I):**

In the integral control mode, the output of the controller is proportional to the integral of the input error signal. Steady-state errors can be eliminated, so that the system has no steady-state errors while operating in the steady state. However, drastic changes cannot be tracked.

**Differential (D):**

In the differential control mode, the output of the controller is proportional to the differential (i.e. change rate of the error) of the input error signal. This can predict the trend of changes in errors, quickly respond to drastic changes, and improve the dynamic features of the system in the control process.

Function code	Function code name	Parameter description	Unit	Default setting	Attribute	Mailing address
F09.00	PID setting source	0: digital PID setting 1: AI1 2: AI2 3: reserved 4: reserved 5: PULSE, high-frequency pulse (X5) 6: communication setting (percentage setting)		0	○	0x0900
F09.01	Digital PID setting	0.0 to PID setting feedback range F09.03		0.0	●	0x0901
F09.03	PID setting feedback range	0.1 ~ 6000.0		100.0	●	0x0903

**F09.00=0: digital PID setting F09.01**

The PID setting depends on the digital PID setting (F09.01), and the specific percentage is F09.01/F09.03 \* 100.00%.

**F09.00=1:AI1**

**F09.00=2:AI2**

For the details of AI1 to AI2, refer to the description of F00.04. For PID setting, the percentage is directly given, and the maximum output is 100.00%.

**F09.00=5: PULSE high-frequency pulse (X5)**

The set percentage of PID is directly dependent on the HDI (percentage).

For the details of AI1-AI2 and X5, see the description of F00.04. When used as the PID setting, the percentage will directly turn the set value, and the maximum output is 100.00%.

**F09.00=6: communication setting**

The percentage of PID setting depends directly on the communication (percentage).

- If the master-slave communication (F10.05=1) is enabled and the inverter works as the slave (F10.06=0), the specific setting percentage is “700FH (master-slave communication setting) \* F10.08 (slave receiving proportional coefficient)”, and the 700FH data range is -100.00% to 100.00%, as detailed in Table 12-31.
- For the general communication (F10.05=0), the specific setting percentage is “7004H (communication setting of process PID setting)”, and the 7004H data range is -100.00% to 100.00%, as detailed in Table 12-31.

Function code	Function code name	Parameter description	Unit	Default setting	Attribute	Mailing address
F09.02	PID feedback source	1: AI1 2: AI2 3: reserved 4: reserved 5: PULSE, high-frequency pulse (X5) 6: communication setting		1	○	0x0902

**F09.02=1: AI1**

**F09.02=2: AI2**

The PID feedback percentage is directly dependent on the AI (percentage).

For the details of AI1 to AI2, see the description of F00.04. When is used as the PID feedback, the percentage will directly turn the feedback value, and the maximum output is 100.00%.

**F09.02=5: PULSE high-frequency pulse (X5)**

The set percentage of PID is directly dependent on the HDI (percentage).

For the details of AI1-AI2 and X5, see the description of F00.04. When used as the PID setting, the percentage will directly turn the set value, and the maximum output is 100.00%.

**F09.02=6: communication setting**

The PID feedback percentage is directly dependent on the communication (percentage).

- If the master-slave communication (F10.05=1) is enabled and the inverter works as the slave (F10.06=0), the specific feedback percentage is “700FH (master-slave communication setting) \* F10.08 (slave receiving proportional coefficient)”, and the

700FH data range is -100.00% to 100.00%, as detailed in Table 12-31.

- For the general communication (F10.05=0), the specific feedback percentage is “7005H (communication setting of process PID feedback)”, and the 7005H data range is -100.00% to 100.00%, as detailed in Table 12-31.

Function code	Function code name	Parameter description	Unit	Default setting	Attribute	Mailing address
F09.04	PID positive and negative action selection	0: positive 1: negative		0	○	0x0904

The process PID action mode depends jointly on the setting of the function code F09.04 and the status of the input function “44: PID positive/negative action switching”, as detailed in Table 7-14.

Table 7-14 Description of PID Positive/Negative Action

F09.04	44: PID positive/negative switching	Mode of action	Note
0	0	Positive action	Both the deviation and output are positive.
0	1	Negative action	The deviation is positive and the output is negative.
1	0	Negative action	The deviation is positive and the output is negative.
1	1	Positive action	Both the deviation and output are positive.

*Note:* The deviation in PID control is usually “setting - feedback”.

- When the feedback signal is greater than the PID setting, the output frequency of the inverter should decrease for PID balance. Take the water supply control as an example. When the pressure increases, the pressure feedback will increase. The output frequency of the inverter must be decreased to reduce the pressure and keep the constant pressure. In this case, the PID should be set to the positive action.
- When the feedback signal is greater than the PID setting, the output frequency of the inverter needs to increase for PID balance. Take temperature control as an example. The PID regulator needs to be set to negative action to control the temperature.



Function code	Function code name	Parameter description	Unit	Default setting	Attribute	Mailing address
F09.05	Proportional gain 1	0.00~100.00		0.40	●	0x0905
F09.06	Integral time 1	0.000 to 30.000; 0.000: no integral	s	2.000	●	0x0906
F09.07	Differential time 1	0.000~30.000	ms	0.000	●	0x0907
F09.08	Proportional gain 2	0.00-100.00		0.40	●	0x0908
F09.09	Integral time 2	0.000 to 30.000; 0.000: no integral	s	2.000	●	0x0909
F09.10	Differential time 2	0.000~30.000	ms	0.000	●	0x090A
F09.11	PID parameter switching conditions	0: no switching 1: switching via digital input terminal 2: automatic switching according to deviation 3: automatic switching by frequency		0	●	0x090B
F09.12	PID parameter switching deviation 1	0.00 ~ F09.13	%	20.00	●	0x090C
F09.13	PID parameter switching deviation 2	F09.12 ~ 100.00	%	80.00	●	0x090D

For a variety of complex scenes, two sets of PID parameters have been introduced into the process PID module. Switching or linear interpolation of the two sets of parameters can be performed according to the function setting (F09.11) and input conditions [e.g. input function “43: PID parameter switching”, and deviation  $e(k)$ ]. See the instruction Table 7-15 for details.

Table 7-15 Description of PID Parameter Options

Method		Description
F09.11	Other conditions	
0	--	PID parameters are not switched. The first group of parameters is used.
1	43: PID parameter switching	PID parameters are switched via the digital input terminal (43: PID parameter switching).
	0	<b>Invalid switching, the first group of parameters</b>
	1	Valid switching, the second group of parameters
2	$ e(k)  - F09.12/13$	PID parameters are automatically switched according to the deviation.
	$ e(k)  < F09.12$	The first group of parameters

	$ e(k)  < F09.13$	The second group of parameters
	Middle	According to the deviation, linear interpolation is performed based on the two groups of parameters.
3	$ P  \sim F09.12/13$	PID parameters are automatically switched by frequency.
	$ P  < F09.12$	The first group of parameters
	$ P  > F09.13$	The second group of parameters
	Middle	According to the frequency, linear interpolation is performed based on the two groups of parameters.

As described in the table, when the function code F09.11 is set to 0, the PID parameters will not be switched, and the first group of parameters (F09.05 to F09.07) will prevail; when the function code is set to 1, the PID parameters will be selected according to the status of the input function “43: PID parameter switching”; when the function code 2 is used, the PID parameters will be selected according to the absolute value  $|e(k)|$  ( $=|\text{setting-feedback}|$ ) of the current deviation and the relationship between the function codes F09.12 and F09.13, or the linear difference may be used; when the function code 3 is used, processing is similar to that of the option 2, the PID parameters will be selected according to the percentage of the current output frequency to maximum frequency  $|P| = (\text{output frequency}/\text{maximum frequency} * 100\%)$  and the relationship between the function codes F09.12 and F09.13, or the linear difference may be used.

In the case of “ $F09.12 \leq |e(k)| \leq F09.13$ ”, the current PID parameters are obtained through linear interpolation of the first and second groups of parameters. The specific principle is shown by the intermediate segment in Fig. 9-28

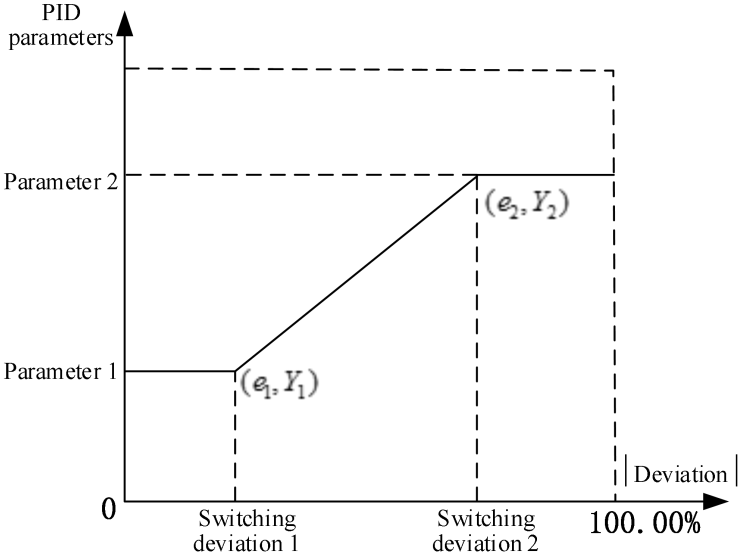

Fig. 9-28 Schematic Diagram of Automatic Switching of PID Parameters based on Deviation

(F19.11=2)

Function code	Function code name	Parameter description	Unit	Default setting	Attribute	Mailing address
F09.14	Initial PID value	0.00~100.00	%	0.00	●	0x090E
F09.15	PID initial value holding time	0.00~650.00	s	0.00	●	0x090F

The inverter starts running, and the process PID module constantly outputs the initial PID value (F09.14) for the initial PID holding time (F09.15). Then the output is adjusted by the PID based on the deviation. Specific effects are shown in Fig. 9-29.

When the initial PID holding time is set to 0.00s, i.e. F09.15=0.00, the initial PID output function will be invalid.

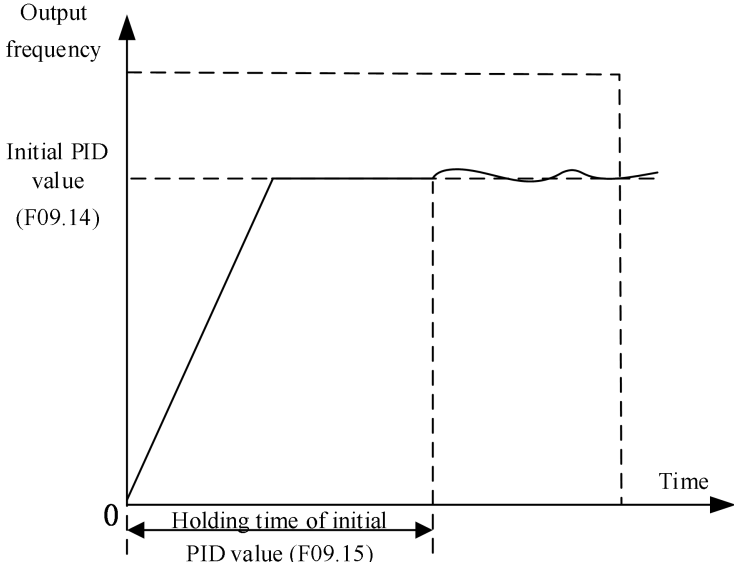

Fig. 9-29 Schematic Diagram of Initial PID Output

Function code	Function code name	Parameter description	Unit	Default setting	Attribute	Mailing address
F09.16	Upper limit of PID output	F09.17 ~ +100.0	%	100.0	●	0x0910
F09.17	Lower limit of PID output	-100.0 ~ F09.16	%	0.0	●	0x0911

The PID output is limited. The output range of the PID module in the whole process is (F09.17, F09.16). That is, if the actual adjustment result is beyond this range, the output will be based on the boundaries.

Function code	Function code name	Parameter description	Unit	Default setting	Attribute	Mailing address
F09.18	PID deviation limit	0.00~100.00 (0.00: invalid)	%	0.00	●	0x0912

When the deviation between the PID setting and feedback is less than or equal to the deviation limit (F09.18), the PID will stop the adjustment. When the deviation between the setting and feedback is smaller, the output frequency will remain stable. This is valid for some closed-loop control applications.



If the input terminal function “41: process PID pause” is valid, the PID will also stop the adjustment. Users need to use these two modes together.

Function code	Function code name	Parameter description	Unit	Default setting	Attribute	Mailing address
F09.19	PID differential limit	0.00~100.00	%	5.00	●	0x0913

The differential (D) component of the PID regulator must not be greater than the PID differential limit (F09.19), in order to avoid the excessive deviation and output at a certain moment to cause system oscillations. If this value is set correctly, the impact of sudden interference on the system can be well suppressed.

Function code	Function code name	Parameter description	Unit	Default setting	Attribute	Mailing address
F09.20	PID integral separation threshold	0.00~100.00 (100.00% = invalid integral separation)	%	100.00	●	0x0914

For better PID regulation, only PD or P adjustment is needed sometimes, while integral adjustment is not needed. For this reason, the EM730 series inverter has a special integral separation function. When the deviation between the PID setting and feedback is greater than the PID integral separation threshold (F09.20), the integral separation will be valid. That is, the integral (I) adjustment of the PID regulator will be suspended. To facilitate remote control, the input terminal function “42: process PID integration pause” can be used. But if the function code setting is invalid (F09.20=100.00), the input terminal function will not work, as detailed in Table 7-16.

Table 7- 16 Description of Integral Separation Function

Method		Description
F09.20	DI(42)	F09.20: PID integral separation threshold; DI (42): Process PID integral pause
100.00%	--	The integral (I) is always valid.
0.00%		Depending on the relationship between $ e(k) $ and F09.20 as well as the status of the DI function
~		
99.99%		
	Invalid	If $ e(k)  > F09.20$ , the integral separation is valid.
	Valid	The integral separation is valid.

Function code	Function code name	Parameter description	Unit	Default setting	Attribute	Mailing address
F09.21	PID setting change time	0.000~30.000	s	0.000	●	0x0915

The PID setting change time refers to the time required for the setting to change from 0.0% to 100.0%, similar to the acceleration and deceleration time function. When the PID setting changes, the actual PID setting will change linearly, thus reducing the impact of sudden changes on the system. Smoothing is invalid during the initial setting. The setting will change from the current feedback value during the start.

Function code	Function code name	Parameter description	Unit	Default setting	Attribute	Mailing address
F09.22	PID feedback filtering time	0.000~30.000	s	0.000	●	0x0916
F09.23	PID output filtering time	0.000~30.000	s	0.000	●	0x0917

F09.22 is used to filter the PID feedback. This is helpful to reduce the impact of interference on the feedback, but will cause the decline of the response performance of the process closed-loop system.

F09.23 is used to filter the PID output. This is helpful to reduce the sudden changes in the output frequency of the inverter, but will also cause the decline of the response performance of the process closed-loop system.

Function code	Function code name	Parameter description	Unit	Default setting	Attribute	Mailing address
F09.24	Upper limit detection value of PID feedback disconnection	0.00~100.00; 100.00 = invalid feedback disconnection	%	100.00	●	0x0918
F09.25	Lower limit detection value of PID feedback disconnection	0.00~100.00; 0.00 = invalid feedback disconnection	%	0.00	●	0x0919
F09.26	Detection time of PID feedback disconnection	0.000~30.000	s	0.000	●	0x091A

The function of PID feedback disconnection detection is to prevent galloping caused by feedback disconnection. Depending on the nature of the feedback sensor, the settings are different.

If the 0.0% type sensor is fed back at the time of disconnection, the lower limit of PID feedback disconnection detection (F09.25) needs to be set to an appropriate value. If the

feedback amount is below the F09.25 setting and has been maintained for the PID feedback disconnection detection time (F09.26), the PID feedback will be regarded disconnected. When the 100.0% type sensor is fed back at the time of disconnection, the upper limit of PID feedback disconnection detection (F09.24) needs to be set to an appropriate value. If the feedback amount is greater than the feedback amount and has been maintained for the time corresponding to F09.26, the PID feedback will be regarded disconnected.

- ★ Once the feedback sensor is determined, only the corresponding detection mode can be applied. The upper limit detection and lower limit detection cannot be enabled at the same time.

Function code	Function code name	Parameter description	Unit	Default setting	Attribute	Mailing address
F09.27	PID sleep control options	0: invalid 1: sleep at zero speed 2: sleep at lower frequency limit 3: sleep with tube sealed		0	●	0x091B
F09.28	Sleep action point	0.00~100.00 (100.00 corresponds to the PID setting feedback range)	%	100.00	●	0x091C
F09.29	Sleep delay time	0.0 ~ 6500.0	s	0.0	●	0x091D
F09.30	Wake-up action point	0.00~100.00 (100.00 corresponds to the PID setting feedback range)	%	0.00	●	0x091E
F09.31	Wake-up delay time	0.0 ~ 6500.0	s	0.0	●	0x091F

When the output value and feedback value tend to be stable or the controlled quantity is within the allowable range on some occasions or at a certain moment, and the output is not allowed, the sleep status can be applied for a short time. If the controlled quantity is beyond the control range, the inverter will be awakened and generate the output. These steps will be repeated to make the controlled quantity within the allowable range and also save the energy. The detailed function description is shown in Table 7-17.

Table 7-17 Description of Sleep/Wake-up Function

Method		Description
Mode of action	State	
Positive action (e.g.	Normal work	Judgment of the sleep conditions: If the  Feedback  is greater than the sleep action point (F09.28) (necessary condition: the feedback pressure must be greater than or equal to the set pressure during

constant pressure control)		restart after the stop or sleep), or the output frequency of the inverter reaches the lower limit, causing the failure to continue to decelerate (due to the lower frequency limit or lower output limit of the inverter), and these conditions have been met and maintained to the sleep delay time (F09.29), the sleep status will be enabled. ★: The PID continues the output during the delay period. The output depends on the function code after the delay period.
	Sleep status	Judgment of the wake-up conditions: If the  Feedback  is less than or equal to the value of the wake-up action point (F09.30), and this has been maintained for the wake-up delay time (F09.31), the sleep status will be disabled. ★: The output depends on the function code during the delay period; and the PID can continue normal output after the delay period.
Negative action (e.g. constant temperature control)	Normal work	Judgment of the sleep conditions: If the  Feedback  is less than the sleep action point (F09.28) (necessary condition: the feedback pressure must be lower than or equal to the set pressure during restart after the stop or sleep), or the output frequency of the inverter reaches the lower limit, causing the failure to continue to decelerate (due to the lower frequency limit or lower output limit of the inverter), and these conditions have been met and maintained to the sleep delay time (F09.29), the sleep status will be enabled. ★: The PID continues the output during the delay period. The output depends on the function code after the delay period.
	Sleep status	Judgment of the wake-up conditions: If the  Feedback  is greater than or equal to the value of the wake-up action point (F09.30), and this has been maintained for the wake-up delay time (F09.31), the sleep status will be disabled. ★: The output depends on the function code during the delay period; and the PID can continue normal output after the delay period.

Suggestion: F09.28 (sleep action point) is greater than or equal to F09.30 (wake-up action point) during the positive action, and less than or equal to F09.30 (wake-up action point) during the negative action.

Function code	Function code name	Parameter description	Unit	Default setting	Attribute	Mailing address
F09.32	Multi-segment PID setting 1	0.0 to PID setting feedback range F09.03		0.0	●	0x0920
F09.33	Multi-segment	0.0 to PID setting feedback range		0.0	●	0x0921



	PID setting 2	F09.03				
F09.34	Multi-segment PID setting 3	0.0 to PID setting feedback range F09.03		0.0	●	0x0922

PID settings are determined in conjunction with the setting of the function code F09.00. The EM730 series inverter has a multi-segment PID setting function, and its switching conditions are mainly dependent on the input functions “15: multi-segment PID terminal 1” and “16: multi-segment PID terminal 2”, as detailed in Table 7-16.

Table 7- 18 Details of Multi-segment PID Setting Function

Method			Setting	Scope	PID Setting
16	15	F09.00			
Invalid	Invalid	0	F09.01	0.0 ~ F09.03	0.00% ~ 100.00%
		1	AI1	-100.00% ~ 100.00%	-100.00% ~ 100.00%
		2	AI2	-100.00% ~ 100.00%	-100.00% ~ 100.00%
		6	485	-100.00% ~ 100.00%	-100.00% ~ 100.00%
Invalid	Valid	--	F09.32	0.0 ~ F09.03	0.00% ~ 100.00%
Valid	Invalid	--	F09.33	0.0 ~ F09.03	0.00% ~ 100.00%
Valid	Valid	--	F09.34	0.0 ~ F09.03	0.00% ~ 100.00%

Function code	Function code name	Parameter description	Unit	Default setting	Attribute	Mailing address
F09.35	Upper limit of feedback voltage	Lower limit of feedback voltage to 10.00	V	10.00	●	0x0923
F09.36	Lower limit of feedback voltage	0.00 to upper limit of feedback voltage	V	0.00	●	0x0924

The upper and lower limits of the feedback voltage can be used for automatic material cutoff detection in winding applications. They represent the upper and lower limits of material cutoff, respectively. Due to the particularity of winding applications, F09.35 and F09.36 can be used to reflect the real sensor boundaries, which is more conducive to the system stability.

Function code	Function code name	Parameter description	Unit	Default setting	Attribute	Mailing address
F09.37	Options of integral action within the set change time of PID	0: always calculate the integral term 1: calculate the integral term after the F09.21 set time is reached 2: calculate the integral term when the error is less than F09.38		0	●	0x0925
F09.38	Input deviation of integral action	0.00~100.00	%	30.00	●	0x0926

	within the set change time of PID					
--	-----------------------------------	--	--	--	--	--

**F09.37=0: always calculate the integral term**

This function code does not affect the integral action.

**F09.37=1: calculate the integral term after the F09.21 set time is reached**

The integral is unavailable within the first change period (F09.21) after startup.

**F09.37=2: calculate the integral term when the error is less than F09.38**

The integral is unavailable within the first change period (F09.21) after startup. However, the integral will be enabled again if the error is less than F09.38 within this period.

Function code	Function code name	Parameter description	Unit	Default setting	Attribute	Mailing address
F09.39	Wake-up option	0: target pressure F09.01* coefficient of wake-up action point 1: wake-up action point (F09.30)		0	○	0x0927
F09.40	Coefficient of wake-up action point	0.0 ~100.0 (100% corresponds to PID setting)	%	90.0	●	0x0928

**F09.39=0: target pressure F09.01\* coefficient of wake-up action point**

F09.40\* preset

**F09.39=1: wake-up action point (F09.30)**

The PID will wake up if the value is less than the wake-up point (F09.30) and kept for the wake-up delay time (F09.31).

Function code	Function code name	Parameter description	Unit	Default setting	Attribute	Mailing address
F09.41	Pipeline network alarm overpressure	0.0 to pressure sensor range F09.03	bar	6.0	●	0x0929
F09.42	Overpressure protection time	0~3600 (0: invalid)	s	3	●	0x092A

It is dedicated to the water pump application macro. When the overpressure of the pipeline network reaches the value of F09.41 and kept for the set time (F09.42), the E57 pipeline network overpressure protection will be reported.

Function code	Function code name	Parameter description	Unit	Default setting	Attribute	Mailing address
F09.43	PID reverse limit	0: no limit 1: limit		1	○	0x092B

It is dedicated to the straight wire drawing machine of the winding and unwinding application micro. When F27.00 is set to the option 3 (straight wire drawing machine) and the feedback signal is the maximum value for a long time after startup, the system will be adjusted by PID to the negative output.

**F09.43=0:** No limit

When the output is reduced to 0, it will not be limited and may continue to decrease.

**F09.43=1:** limit

When the output is reduced to 0, it will be limited and not continue to decrease.

## 7.11 Communication Function Parameter Group of F10 Group

The EM730/EM730E series inverter supports the RTU format Modbus protocol, and the “single-master multi-slave” communication network with RS-485 bus.

Function code	Function code name	Parameter description	Unit	Default setting	Attribute	Mailing address
F10.00	Local Modbus communication address	1-247; 0: broadcast address		1	○	0x0A00

For the entire communication network, the inverter as a slave must have its own unique address. Its setting range is 1 to 247. That is, a network supports 247 slave stations at most.

- ★ 0 is the broadcast address, which does not need to be set. All slave inverters can be recognized.

The slaves and hosts attached to the same network must follow the same sending and receiving principles (e.g. baud rate, data format, and protocol format) to ensure normal communication. Hence, there are three corresponding function codes, i.e. F10.01 (baud rate), F10.02 (data format) and F10.10 (protocol format, Modbus-RTU protocol by default for the EM730 series inverter). The devices connected to the network must have the same settings.

Function code	Function code name	Parameter description	Unit	Default setting	Attribute	Mailing address
F10.01	Baud rate of Modbus communication	0:4800 1:9600 2:19200 3:38400 4:57600 5:115200	bps	1	○	0x0A01

During the communication based on the Modbus-RTU protocol, the EM730 series inverter supports six different baud rates in bps (bit/s). Take F10.01=9600bps as an example. It means that data is transmitted at a rate of 9600bits per second. By default, each byte consists of valid

8-bit data (such as 0x01). When 10-bit data needs to be transmitted in the actual situation, the transmission time is about 1.04ms (approximately 1.04167ms=10bit/9600bps).

Function code	Function code name	Parameter description	Unit	Default setting	Attribute	Mailing address
F10.02	Modbus data format	0: 1-8-N-1 (1 start bit + 8 data bits + 1 stop bit) 1: 1-8-E-1 (1 start bit + 8 data bits + 1 even parity check bit + 1 stop bit) 2: 1-8-O-1 (1 start bit + 8 data bits + 1 odd parity check bit + 1 stop bit) 3: 1-8-N-2 (1 start bit + 8 data bits + 2 stop bits) 4: 1-8-E-2 (1 start bit + 8 data bits + 1 even parity check bit + 2 stop bits) 5: 1-8-O-2 (1 start bit + 8 data bits + 1 odd parity check bit + 2 stop bits)		0	○	0x0A02

In the UART transmission, the data usually consists of a start bit, valid data (8 bits by default), check bit (optional), and a stop bit. The EM730/EM730E series inverter supports six data formats according to the Modbus-RTU combinations in communication.

Start Bit	Valid Data								Check Bit	Stop Bit
1	7	6	5	4	3	2	1	0	N/O/E	1

If F10.02=0, it means that the current data consists of one start bit + eight data bits + no check bit + one stop bit.

★ N (NONE): no parity; E (EVEN): even parity; O (ODD), odd parity.

In order to meet different needs, the inverter also supports communication timeout and response delay during the communication based on the Modbus protocol.

Function code	Function code name	Parameter description	Unit	Default setting	Attribute	Mailing address
F10.03	Modbus communication timeout	0.0 to 60.0; 0.0: invalid (also valid for master-slave mode)	s	0.0	●	0x0A03

As shown in Fig. 7-30, the communication time interval  $\Delta t$  is defined as the period from the previous reception of valid data frames by the slave station (inverter) to next reception of valid data frames. If  $\Delta t$  is greater than the set time (depending on the function code F10.03; this

function is invalid if set to 0), it will be regarded communication timeout.

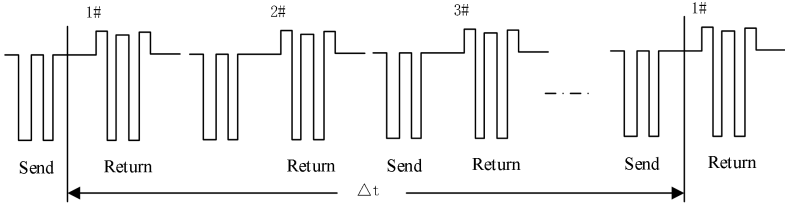

Fig. 7-30 Schematic Diagram of Communication Timeout

Example of this function: If the master station must send data to a slave station (e.g. #1) within a certain period, you can use the communication timeout function of #1 slave station and set  $F10.03 > T$ . The communication timeout protection will not be triggered during normal communication. However, if the master station does not send data to #1 slave station within the specified time T, and this lasts for more than the set value of F10.03, a communication protection (E16) will be reported. Once informed of the “communication protection of #1 slave station”, the staff can conduct troubleshooting.

★ The set value of F10.03 must be greater than the set time T, but must not be too large, in order to avoid adverse effects arising from too long operation in the protection status.

★ F10.03 should be set to be invalid under normal circumstances. This parameter will be set only in the continuous communication system to monitor the communication.

Function code	Function code name	Parameter description	Unit	Default setting	Attribute	Mailing address
F10.04	Modbus response delay	1 ~ 20	ms	2	●	0x0A04

The response delay ( $t_{wait2}$ ) is defined as the time interval from the reception of the valid data frame 1 by the inverter to data parsing and return. To ensure the stable operation of the protocol chip, the response delay should be set within 1~20ms (it must not be set to 0). **If the communication data involves EEPROM operation, the actual response delay time will be extended, i.e. “EEPROM operation time + F10.04”.**

1: valid data frame: sent by the external master station to inverter, in which the function code, data length and CRC are correct.

Fig. 7-31 shows the data sending segment ( $t_{send}$ ), sending end segment ( $t_{wait1}$ ), 75176-to-sending wait segment ( $t_{wait2}$ ), data return segment ( $t_{return}$ ), and 75176-to-receiving wait segment ( $t_{wait3}$ ).

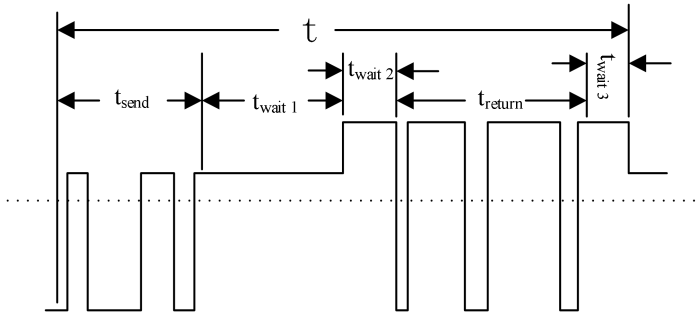

Fig. 7-31 Timing Parse Diagram of Complete Data Frame

Function code	Function code name	Parameter description	Unit	Default setting	Attribute	Mailing address
F10.05	Options of master-slave communication function	0: invalid 1: valid		0	○	0x0A05
F10.06	Master-slave options	0: slave 1: host (Modbus protocol broadcast transmission)		0	○	0x0A06
F10.07	Data sent by host	0: output frequency 1: set frequency 2: output torque 3: set torque 4: PID setting 5: output current		1	○	0x0A07
F10.08	Proportional factor of slave reception	0.00~10.00 (multiple)		1.00	●	0x0A08
F10.09	Host sending interval	0.000~30.000	s	0.200	●	0x0A09

The EM730 series inverter supports the master-slave communication function. That is, one inverter works as the host and others as slaves. The slaves work according to the command sent by the host, so that these inverters can work synchronously.

- The inverter used as the host is set as follows:

F10.05=1: enable the master-slave communication function;

F10.06=1 or 2: select the current inverter as the host (only one inverter can be set as the host in a network);

F10.07: select the variable to be synchronized, such as the output current (set F10.07=5).

- The inverter is used as the slave is set as follows:

F10.05=1: enable the master-slave communication function;

F10.06=0: select the current inverter as the slave;

Select one setting as the communication setting. If F09.00=6 is set and the process PID is set separately (F00.05=10, F00.06=1), the slave inverter will be set to the host output current for PID adjustment.

You can set the receiving proportional coefficient (F10.08) to determine how the slave inverter receives data. If F10.08=0.80 is set, the final application data is “Recv (received data) \* 0.80 (F10.08)”.

Function code	Function code name	Parameter description	Unit	Default setting	Attribute	Mailing address
F10.56	Options of 485 EEPROM writing	0-10: default operation (for commissioning) 11: writing not triggered (available after commissioning)		0	○	0x0A38

For the application “PLC controller/HMI + inverter”, you can set F10.56=11 after debugging. Then all write data of PLC communication will not be stored, which can avoid damage to the memory.

If you need parameter settings and power-down storage, set F10.56=0 first.

Function code	Function code name	Parameter description	Unit	Default setting	Attribute	Mailing address
F10.61	SCI response option	0: reply to both read and write commands 1: reply to write commands only 2: no reply to both read and write commands		0	○	0x0A3D

F10.61=0: During the Modbus communication with the upper computer, both read and write parameters will be returned to the upper computer.

F10.61=1: During the Modbus communication with the upper computer, the read parameters will be returned to the upper computer, while the write parameters will not.

F10.61=2: During the Modbus communication with the upper computer, both read and write parameters will not be returned to the upper computer. This can improve the communication efficiency.

## 7.12 User-selected Parameter Group of F11 Group

The keyboard of the EM730 series inverter supports the user-selected function. First, the user should select specific function codes by setting the parameters of the F11 group. Then the user-selected mode (--U--, as detailed in 4.2.2) can be enabled. The selected function codes can be switched cyclically by turning the digital potentiometer key . This function is mainly used where less than 32 specific function codes are involved, which can avoid the trouble caused by too many function codes.

Function code	Function code name	Parameter description	Unit	Default setting	Attribute	Mailing address
F11.00	User-selected parameter 1	The displayed content is Uxx.xx, which means that the Fxx.xx function code is selected. If the F11.00 function code is enabled, the keyboard will display U00.00, indicating the first optional parameter F00.00.		U00.00	●	0x0B00
F11.01	User-selected parameter 2			U00.01	●	0x0B01
F11.02	User-selected parameter 3			U00.02	●	0x0B02
F11.03	User-selected parameter 4			U00.03	●	0x0B03
F11.04	User-selected parameter 5			U00.04	●	0x0B04
F11.05	User-selected parameter 6			U00.07	●	0x0B05
F11.06	User-selected parameter 7			U00.14	●	0x0B06
F11.07	User-selected parameter 8			U00.15	●	0x0B07
F11.08	User-selected parameter 9			U00.16	●	0x0B08
F11.09	User-selected parameter 10			U00.18	●	0x0B09
F11.10	User-selected parameter 11			U00.19	●	0x0B0A
F11.11	User-selected parameter 12			U00.29	●	0x0B0B
F11.12	User-selected parameter 13			U02.00	●	0x0B0C
F11.13	User-selected parameter 14			U02.01	●	0x0B0D
F11.14	User-selected parameter 15			U02.02	●	0x0B0E
F11.15	User-selected parameter 16			U03.00	●	0x0B0F



F11.16	User-selected parameter 17		U03.02	●	0x0B10
F11.17	User-selected parameter 18		U03.21	●	0x0B11
F11.18	User-selected parameter 19		U04.00	●	0x0B12
F11.19	User-selected parameter 20		U04.20	●	0x0B13
F11.20	User-selected parameter 21		U05.00	●	0x0B14
F11.21	User-selected parameter 22		U05.03	●	0x0B15
F11.22	User-selected parameter 23		U05.04	●	0x0B16
F11.23	User-selected parameter 24		U08.00	●	0x0B17
F11.24	User-selected parameter 25		U19.00	●	0x0B18
F11.25	User-selected parameter 26		U19.01	●	0x0B19
F11.26	User-selected parameter 27		U19.02	●	0x0B1A
F11.27	User-selected parameter 28		U19.03	●	0x0B1B
F11.28	User-selected parameter 29		U19.04	●	0x0B1C
F11.29	User-selected parameter 30		U19.05	●	0x0B1D
F11.30	User-selected parameter 31		U19.06	●	0x0B1E
F11.31	User-selected parameter 32		U19.12	●	0x0B1F



F11.00=U00.00, indicating that the first user-selected parameter is the function code F00.00. The function codes in the user-selected mode of the keyboard are switched according to the function code order from F11.00 to F11.31.

### 7.13 Keyboard and Display Function Parameter Group of F12 Group

Function code	Function code name	Parameter description	Unit	Default setting	Attribute	Mailing address
F12.00	M.K multi-function key options	0: no function 1: forward jog 2: reverse jog 3: forward/reverse switching 4: quick stop 5: free stop 6: cursor movement to the left		1	○	0x0C00

 is a multi-function key, of which the function can be performed by setting the function code F12.00. If F12.00=0, this key has no effect when pressed. For other settings, the corresponding effects will be obtained when this key is pressed.

Function code	Function code name	Parameter description	Unit	Default setting	Attribute	Mailing address
F12.01	Options of stop function of STOP key	0: valid only in keyboard control 1: with all command channels valid		1	○	0x0C01

According to the setting of the function code F00.02 (command source option), the command sources are divided into the keyboard, terminal and communication. If the terminal is selected as the current command source, the Run  and Stop  key on the keyboard will be unavailable. In more dangerous cases, however, the fastest way is to stop the inverter via the Stop  key on the keyboard to resolve dangers. It is the most convenient to use the keyboard to stop the inverter during normal operation. Therefore, the function code “F12.01: stop function options of the STOP key” is added. In addition, the STOP key is always valid by default.

★ It is recommended not to modify this parameter. If necessary, please set it carefully.

Function code	Function code name	Parameter description	Unit	Default setting	Attribute	Mailing address
F12.02	Parameter locking	0: do not lock 1: reference input not locked 2: all locked, except for this function code		0	●	0x0C02

In order to avoid unnecessary danger caused by keyboard operation or misoperation of

non-workers, the keyboard has a parameter locking function. The current function code is unlocked by default, and all function codes can be set. After the function code is debugged according to the working conditions, the parameters can be locked.

● 1: reference input not locked



In the lock mode, all function codes cannot be modified, except this function code and those with reference input properties. Specific function codes with parameter input properties are shown in Table 7-19:

Table 7-19 List of Function Codes with Reference Input Properties

Function code	Function code name	Function code	Function code name
F00.07	Digital frequency setting	F08.11	Multi-segment speed 12
F08.00	Multi-segment speed 1	F08.12	Multi-segment speed 13
F08.01	Multi-segment speed 2	F08.13	Multi-segment speed 14
F08.02	Multi-segment speed 3	F08.14	Multi-segment speed 15
F08.03	Multi-segment speed 4	F13.02	Digital torque setting
F08.04	Multi-segment speed 5	F09.01	Digital PID setting
F08.05	Multi-segment speed 6	F09.32	Multi-segment PID setting 1
F08.06	Multi-segment speed 7	F09.33	Multi-segment PID setting 2
F08.07	Multi-segment speed 8	F09.34	Multi-segment PID setting 3
F08.08	Multi-segment speed 9	F13.03	Multi-segment torque 1
F08.09	Multi-segment speed 10	F13.04	Multi-segment torque 2
F08.10	Multi-segment speed 11	F13.05	Multi-segment torque 3

● 2: all locked, except for this function code

In the lock mode, all function codes cannot be set except this function code. This mode is mostly used when it is not necessary to set parameters after debugging. We can only perform running, stop and parameter monitoring in this mode.

We can press the ESC key  to enable the monitoring mode (see 4.4 When the inverter is in the protection status, you can directly press the right shift key  to switch the current protection type and the output frequency, output current, output voltage, running status and working time during the protection.

Operation Monitoring: press the right shift key  to display the parameters in cycles. The function codes F12.04 to F12.08 are used to select the parameters to be displayed in the cycle display queue. The selected items basically correspond to the monitoring parameter group of the F18 group, so you can directly view the current values of all parameters in the F18 group.

This function is mainly conducive to parameter display, especially during operation.

By default, several common items are included in the cycle display queue, including the output frequency (F18.00), set frequency (F18.01), output current (F18.06), output voltage (F18.08) and DC bus voltage (F18.09). Please set the corresponding bit to 1 to select other display parameters and 0 to hide the selected parameters.

- ★ Some bits of the function codes for display parameter selection are reserved. Please set them carefully.

Function code	Function code name	Parameter description	Unit	Default setting	Attribute	Mailing address
F12.03	Parameter copying	0: no operation 1: parameter upload to keyboard 2: download parameters to inverter (F01 and F14 groups do not download) 3: parameters are downloaded to inverter		0	○	0x0C03

Where several inverters need to run with the same parameter settings, we can debug one inverter first, set it to F12.03=1 to upload the set parameters to the keyboard for temporary storage and finally set the other inverters to F12.03=2 (Do not download motor parameters or F12.03=3 download motor parameters) to download the parameters to these inverters. This function can be applied to quickly set the parameters of several inverters. Even if some parameter settings are different, this function can be applied to set multiple function codes before setting by other means.

Function code	Function code name	Parameter description	Unit	Default setting	Attribute	Mailing address
F12.09	Load speed display coefficient	0.01~600.00		30.00	●	0x0C09

The inverter output is mostly displayed in the frequency form. To set the current load speed (F18.13), you can change the current parameter from frequency output to speed output based on the actual working conditions, so that F18.14 displays the current load speed correctly.

If F12.09=30.00 (related to the number of motor pole pairs, transmission ratio and the like), the output frequency (0.00 to 50.00 Hz) corresponds to the load speed (0 to 1500 rpm).

Function code	Function code name	Parameter description	Unit	Default setting	Attribute	Mailing address
F12.10	UP/DOWN acceleration and deceleration rate	0.00: automatic rate 0.01 ~ 500.00	Hz/s	5.00	○	0x0C0A
F12.11	Options of UP/DOWN offset clearing	0: do not clear 1: clear in non-running state 2: clear when UP/DOWN invalid 3: clear once in non-running state		0	○	0x0C0B
F12.12	Options of UP/DOWN power-down saving of offset	0: do not save 1: save (valid after the offset is modified)		1	○	0x0C0C

The UP/DOWN functions are mainly divided into the keyboard UP/DOWN and terminal UP/DOWN, which are handled separately and can be enabled at the same time.

- Keyboard UP/DOWN: It is valid in the Level 0 monitoring menu. When the current setting is not the digital potentiometer setting, the UP function can be performed by forward spinning of the digital potentiometer via the keyboard and the DOWN function by reverse spinning.
- During the forward or reverse spinning of the digital potentiometer under the monitoring menu, the offset frequency will increase/decrease at the rate of F12.10, the keyboard will display “F18.01: set frequency”, and the final frequency will be the set frequency plus offset frequency. The keyboard will have the normal display 2 s after the key is released.
- Terminal UP/DOWN: After the digital input port is set to the corresponding function, terminal control will be enabled.

When the UP/DOWN terminal is valid, the offset frequency will increase/decrease at the rate of F12.10 and the final frequency is the set frequency plus offset frequency. The display content of the keyboard remains unchanged during this period.

- ★ When the keyboard UP and terminal DOWN are valid at the same time, or the keyboard DOWN and terminal UP are valid at the same time, despite of the same acceleration and deceleration rates, the offset frequency will fluctuate because of different valid moments. This is a normal phenomenon.

Function code	Function code name	Parameter description	Unit	Default setting	Attribute	Mailing address
F12.13	Power meter resetting	0: do not clear 1: clear		0	●	0x0C0D

The EM730 series inverter has a watt-hour meter function (see the description of the function codes F18.18 and F18.19). The user can set the current function code to 1 to clear the current count.

Function code	Function code name	Parameter description	Unit	Default setting	Attribute	Mailing address
F12.14	Restoration of default setting	0: no operation 1: restoration of factory defaults (excluding the motor parameters, inverter parameters, manufacturer parameters, running and power-on time record)		0	○	0x0C0E

You can set this parameter to 1 to restore the default settings of all parameters, except the motor parameters (F01 group), inverter parameters, manufacturer parameters, power-on time (F12.15/16) and operating time (F12.17, 18).

★ This operation is irreversible. Please set it carefully.

Function code	Function code name	Parameter description	Unit	Default setting	Attribute	Mailing address
F12.15	Cumulative power-on time (h)	0 ~ 65535	h	0	×	0x0C0F
F12.16	Cumulative power-on time (min)	0 ~ 59	min	0	×	0x0C10

F12.15 and F12.16 are used together to check the cumulative power-on time of the inverter from delivery to the current moment (you only need to power on the inverter). The cumulative power-on time is accurate to one minute and nearly 65536 hours (about 7.5 years) at most.

If F12.15=50 and F12.16=33, it means that the current inverter has been powered on for 2 days, 2 hours and 33 minutes.

★ This parameter can be viewed only and cannot be changed or cleared.

Function code	Function code name	Parameter description	Unit	Default setting	Attribute	Mailing address
F12.17	Cumulative running time (h)	0 ~ 65535	h	0	×	0x0C11
F12.18	Cumulative running time (min)	0 ~ 59	min	0	×	0x0C12

F12.17 and F12.18 are used together to check the cumulative operating time of the inverter from delivery to the current moment (the inverter should be in the running status). The cumulative power-on time is accurate to one minute and nearly 65536 hours (about 7.5 years) at most.

If F12.17=47 and F12.18=39, it means that the current inverter has been running for 1 day, 23 hours and 39 minutes.

- ★ This parameter can be viewed only and cannot be changed or cleared.

Function code	Function code name	Parameter description	Unit	Default setting	Attribute	Mailing address
F12.19	Rated power of inverter	0.40 ~ 650.00	kW	Depending on the motor type	×	0x0C13
F12.20	Rated voltage of inverter	60 ~ 690	V	Depending on the motor type	×	0x0C14
F12.21	Rated current of inverter	0.1 ~ 1500.0	A	Depending on the motor type	×	0x0C15

It is used to view the rated power, rated voltage and rated current of the current inverter.

- ★ This parameter is can be viewed only and cannot be changed.

Function code	Function code name	Parameter description	Unit	Default setting	Attribute	Mailing address
F12.22	Performance software S/N 1	XXX.XX		XXX.XX	×	0x0C16
F12.23	Performance software S/N2	XX.XXX		XX.XXX	×	0x0C17
F12.24	Functional software S/N 1	XXX.XX		XXX.XX	×	0x0C18
F12.25	Functional software S/N 2	XX.XXX		XX.XXX	×	0x0C19
F12.26	Keyboard software serial number 1	XXX.XX		XXX.XX	×	0x0C1A
F12.27	Keyboard software serial number 2	XX.XXX		XX.XXX	×	0x0C1B

It is used to view the software version of the current inverter.

- ★ This parameter is can be viewed only and cannot be changed.

Function code	Function code name	Parameter description	Unit	Default setting	Attribute	Mailing address
F12.33	Running status display parameter 1 of Mode 1 (LED stop status display parameter 5)	0.00 ~ 99.99		18.00	●	0x0C21
F12.34	Running status display parameter 2 of Mode 1 (LED stop status display parameter 1)	0.00 ~ 99.99		18.01	●	0x0C22
F12.35	Running status display parameter 3 of Mode 1 (LED stop status display parameter 2)	0.00 ~ 99.99		18.06	●	0x0C23
F12.36	Running status display parameter 4 of Mode 1 (LED stop status display parameter 3)	0.00 ~ 99.99		18.08	●	0x0C24
F12.37	Running status display parameter 5 of Mode 1 (LED stop status display parameter 4)	0.00 ~ 99.99		18.09	●	0x0C25

**F12.32=0:** monitoring mode 0. The LED switching display and LCD small-line (7-line) display are dependent on the settings of the function codes F12.04 to F12.08. For the selected function codes, please refer to their parameter description.

**F12.32=1:** monitoring mode 1. The LED switching display and LCD small-line (7-line) display are dependent on the settings of the function codes F12.33 to F12.37. You can select any function code. F12.33=18.00 means that the function code F18.00 is displayed.

Function code	Function code name	Parameter description	Unit	Default setting	Attribute	Mailing address
F12.41	Options of UP/DOWN zero crossing	0: prohibit zero crossing 1: allow zero crossing		0	○	0x0C29

The UP/DOWN function is valid. When F12.41=0, the UP/DOWN function can reduce the output frequency of the inverter to 0 without reversing. When F12.41=1, the UP/DOWN function can reduce the output frequency of the inverter to 0, followed by reverse running of the motor.

For the digital potentiometer setting, see the setting of the main frequency source A.



Function code	Function code name	Parameter description	Unit	Default setting	Attribute	Mailing address
F12.42	Frequency setting of digital potentiometer	0.00 to maximum frequency F00.16	Hz	0.00	×	0x0C2A
F12.43	Digital potentiometer torque setting	0.00~ Digital torque setting F13.02	%	0.0	×	0x0C2B

For the digital potentiometer setting, see the setting of the main frequency source A.

F12.45	UP/DOWN function options of keyboard	D7	D6	D5	D4	D3	D2	D1	D0	00000	○	0x0C2D
		*	*	*	Communication	High-speed pulse	Analog quantity	Digital frequency	Multi-segment speed			
		0: invalid 1: valid										

Select the up/down function in the corresponding frequency setting mode.

If the default frequency source is the digital frequency:

In case of F12.45 = 00000, the UP/DOWN function is unavailable, and the set frequency cannot be changed by the digital potentiometer in the monitoring status.

In case of F12.45 = 00010, the UP/DOWN function is available, and the set frequency of the main channel can be changed by the digital potentiometer in the monitoring status.

### 7.14 Torque Control Parameter Group of F13 Group

Function code	Function code name	Parameter description	Unit	Default setting	Attribute	Mailing address
F13.00	Speed/torque control options	0: speed control 1: torque control		0	○	0x0D00

#### **F13.00=0: speed control**

The control mode is speed input, and the input is frequency.

#### **F13.00=1: torque control**

The input control mode is torque input, and the input is the percentage of the rated torque current of the motor. This is valid only in the mode of speed sensorless vector control (SVC), i.e. F00.01=1.

The final control mode is also related to the function terminals “29: torque control prohibition” and “28: speed control/torque control switching” as detailed below Table 7-18.

Table 7- 20 Details of Final Control Mode of Inverter

29: torque control prohibition	28: speed control/torque control switching	F13.00	Final control
Valid	*	*	Speed control
Invalid	Valid	0	Torque control
		1	Speed control
	Invalid	0	Speed control
		1	Torque control

Function code	Function code name	Parameter description	Unit	Default setting	Attribute	Mailing address
F13.01	Options of torque setting source	0: digital torque setting F13.02 1: AI1 2: AI2 3: reserved 4: reserved 5: high frequency pulse input (X5) 6: Communication setting (Full range of the items 1-6, corresponding to F13.02 digital torque setting) 7: reserved 8: digital potentiometer setting		0	○	0x0D01
F13.02	Digital torque setting	-200.0 to 200.0 (100.0 = the rated torque of motor)	%	100.0	●	0x0D02

**F13.01=0: digital torque setting F13.02**

The torque depends on F13.02.

**F13.01=1:AI1**

**F13.01=2:AI2**

The torque is dependent on AI (percentage) \* F13.02.

**F13.01=5: High-frequency pulse input (X5)**

The torque depends on HDI (percentage)\*F13.02.

For the details of AI1-AI2 and X5, refer to the F00.04 description. They have the same meaning. 100.00% is the percentage to the set value of F13.02 (digital torque setting).

**F13.01=6: communication setting**

The torque depends on the communication and the like.

- If the master-slave communication (F10.05=1) is enabled and the inverter works as the slave (F10.06=0), the specific feedback percentage is “700FH (master-slave communication setting) \* F10.08 (slave receiving proportional coefficient)”, and the 700FH data range is -100.00% to 100.00%, as detailed in Table 12-31.

For the general communication (F10.05=0), the specific setting percentage is “7003H (torque communication setting) \* F13.02 (digital torque setting)”, and the 7003H data range is -200.00% to 200.00%, as detailed in Table 12-31.

**F13.01=8: digital potentiometer setting**

In the torque mode, the torque is directly set by the digital potentiometer. See F12.43 for the specific value.

Function code	Function code name	Parameter description	Unit	Default setting	Attribute	Mailing address
F13.03	Multi-segment torque 1	-200.0 ~ 200.0	%	0.0	●	0x0D03
F13.04	Multi-segment torque 2	-200.0 ~ 200.0	%	0.0	●	0x0D04
F13.05	Multi-segment torque 3	-200.0 ~ 200.0	%	0.0	●	0x0D05

For diversified torque applications, the EM730 series inverter supports the multi-segment torque function. Specifically, the input terminal functions “17: multi-segment torque terminal 1” and “18: multi-segment torque terminal 2” need to be set. See the instruction Table 7-21 for details.

Table 7-21 Combination of Multi-segment Torque Command and Multi-segment Torque Terminal

18: multi-segment torque terminal 2	17: multi-segment torque terminal 1	Number of Segments	Torque setting
Invalid	Invalid	Multi-segment torque 1	Depending on the F13.01 setting
Invalid	Valid	Multi-segment torque 2	F13.03
Valid	Invalid	Multi-segment torque 3	F13.04
Valid	Valid	Multi-segment torque 4	F13.05

Function code	Function code name	Parameter description	Unit	Default setting	Attribute	Mailing address
F13.06	torque control acceleration and deceleration time	0.00 ~ 120.00	s	0.05	●	0x0D06

The motor speed can be changed gently by setting the acceleration and deceleration time of torque control.

F13.06 represents the time for the torque current to rise from 0 to the rated torque current or fall from the rated current to 0.

Function code	Function code name	Parameter description	Unit	Default setting	Attribute	Mailing address
F13.08	Upper frequency limit options of torque control	0: set by F13.09 1: AI1 2: AI2 3: reserved 4: reserved 5: high frequency pulse input (X5) 6: communication percentage setting 7: direct communication setting		0	○	0x0D08
F13.09	Upper frequency limit of torque control	0.50 to maximum frequency F00.16	Hz	50.00	●	0x0D09
F13.10	Upper frequency limit offset	0.00 to maximum frequency F00.16	Hz	0.00	●	0x0D0A
F13.18	Reverse speed limit options	0 ~ 100	%	100	●	0x0D12
F13.19	Speed priority enabling of torque control	0: disable 1: enable		1	●	0x0D13

**F13.08=0: depending on F13.09**

The upper frequency limit depends on F13.09 during torque control.

**F13.08=1:AI1**

**F13.08=2:AI2**

The upper frequency limit in torque control is AI (percentage) \* F13.09.

For the details of AI1 and AI2, refer to the F00.04 description. They have the same meaning. 100.00% is the percentage to the set value of F13.09 (upper frequency limit of torque control).

**F13.08=5: High-frequency pulse input (X5)**

The upper frequency limit in torque control is HDI (percentage) \* F13.09.

For the details of AI1-AI2 and X5, refer to the F00.04 description. They have the same

meaning. 100.00% is the percentage to the set value of F13.09(upper limit frequency of torque control).

**F13.08=6 or 7: communication setting**

The torque depends on the communication and the like.

- If the master-slave communication (F10.05=1) is enabled and the inverter works as the slave (F10.06=0), the upper frequency limit is “700FH (master-slave communication setting) \* F10.08 (slave receiving proportional coefficient) \* F00.18 (upper frequency limit)”, and the 700FH data range is -100.00% to 100.00%, as detailed in Table 12-31.
- For general communication (F10.05=0):
  - a、 F13.08=6: the upper frequency limit is “700BH (communication percentage setting of the upper frequency limit of torque control) \* F13.09 (upper frequency limit of torque control)”;
  - b、 F13.08=7: the upper frequency limit is “7018H (communication setting of the upper frequency limit of torque control)”.

The 700BH data range is 0.00% to 200.00%, and the 7018H data range is 0.00 to F00.16 (maximum frequency), as detailed in Table 12-31.

The upper frequency limit of torque control is used to set the maximum forward or reverse running frequency of the inverter in the torque control mode.

In the torque control mode, if the load torque is less than the output torque of the motor, the motor speed will rise continuously, and the maximum speed of the motor must be limited during torque control to prevent the mechanical system from galloping and other accidents; if the load exceeds the output torque of the motor and even the motor is drive to run reversely, the maximum operating load frequency of the motor is still restricted in the case of F13.19=1 and not restricted in the case of F13.19=0.

The upper frequency limit of reverse running is dependent on  $F13.09 * F13.18$ .

Example: The torque is set to be positive and the upper frequency limit of torque control is the AI1 analog input. When the AI1 analog input is positive, the upper frequency limit corresponding to the forward speed limit is  $AI1$  (percentage) \* F13.09 and that corresponding to the reverse speed limit is  $AI1$  (percentage) \* F13.09 \* F13.18; and when the AI1 analog input is

negative, the upper frequency limit corresponding to the forward speed limit is A11 (percentage) \* F13.09 \* F13.18 and that corresponding to the reverse speed limit is A11 (percentage) \* F13.09.

Maximum operating frequency in torque control = upper frequency limit of torque control + offset of upper frequency limit (valid only when F13.08=1 to 5), but the maximum operating frequency is limited by the maximum frequency of F00.16.

Function code	Function code name	Parameter description	Unit	Default setting	Attribute	Mailing address
F13.11	Static friction torque compensation	0.0 ~ 100.0	%	0.0	●	0x0D0B
F13.12	Frequency range of static friction compensation	0.00 ~ 50.00	Hz	1.00	●	0x0D0C
F13.13	Dynamic friction torque compensation	0.0 ~ 100.0	%	0.0	●	0x0D0D

When the motor drives an object to move, it is necessary to overcome static/dynamic friction. You can set this group of parameters to enable the motor rotation at the specified torque while overcoming the inherent static/dynamic friction. The motor is mainly subject to static friction before rotation and dynamic friction after starting rotating. In short, the output performance of the motor is related to this group of parameters.

The specific description of this group of parameters is as follows: “when the actual frequency (estimate frequency in SVC) is less than or equal to the set value of F13.12, the output torque is the ‘set torque + F13.11 static friction torque compensation’; and when the actual frequency is greater than the set value of F13.12, the output torque is ‘set torque + F13.13 dynamic friction torque compensation’”. The larger the compensation value, the stronger the compensation force will be. The compensation percentage is equal to the torque setting percentage.

### 7.15 Parameter Group of Motor 2 of F14 group

The two motors of the EM730 series inverter can be switched. For the two motors, the motor nameplate parameters, encoder parameters and VF control or vector control parameters can be set separately, and the VF control or vector control can be selected independently. In addition, the parameters of the two motors can be tuned separately.

All motor parameters in the second group are included in the F14 group, and the function

codes are defined the same as those in the first group. The function codes F14.00 to F14.34 correspond to F01.00 to F01.34, which are motor nameplate parameters, motor parameters and encoder parameters; the function code F14.35 corresponds to F00.01, which is used to select the motor drive mode; the function codes F14.36 to F14.76 correspond to F06.00 to F06.40, which are vector control parameters; and the function code F14.77 is used to select the acceleration/deceleration time of the motor 2. Only the parameters of F14.72 are described below. For the rest of the parameters, refer to the relevant parameters of the motor 1.

Function code	Function code name	Parameter description	Unit	Default setting	Attribute	Mailing address
F14.52	Stiffness coefficient of speed loop of motor 2	0~20		12	●	0x0E34

In the vector control mode, the dynamic speed response of the inverter is adjusted by changing the speed proportional gain (ASR\_P) and speed integral time (ASR\_T) of the speed PI regulator. The increase in ASR\_P or decrease in ASR\_T may accelerate the dynamic response of the speed loop. If ASR\_P is too large or ASR\_T is too small, however, the system may be over-tuned to cause oscillation.

In case of any change in F14.52, the default settings of F14.36-F14.39 will change accordingly. The regulation intensity of the PI regulator for the speed of the motor 2 can be adjusted. There are 21 groups of parameters in total. The larger the set value of F14.52, the smaller the integral time is, and the more intense the speed PID regulation is. The smaller the set value of F14.52, the weaker the speed PID regulation is.

Function code	Function code name	Parameter description	Unit	Default setting	Attribute	Mailing address
F14.77	Acceleration/deceleration time options of motor 2	0: the same as motor 1 1: acceleration and deceleration time 1 2: acceleration and deceleration time 2 3: acceleration and deceleration time 3 4: acceleration and deceleration time 4		0	○	0x0E4D

**F14.77=0:** the acceleration/deceleration time of the motor 2 is the same as that of the motor 1. For details, see the description of the function codes F15.03 to F15.09;

**F14.77=1/2/3/4:** the acceleration/deceleration time of the motor 2 is fixed as the acceleration/deceleration time 1/2/3/4, corresponding to the function codes F00.14, F00.15/F15.03, F15.04/F15.05, F15.06/F15.07 and F15.08, respectively.

Function code	Function code name	Parameter description	Unit	Default setting	Attribute	Mailing address
F14.78	Maximum frequency of motor 2	20.00~600.00	Hz	50	○	0x0E4E
F14.79	Upper frequency limit of motor 2	Lower limit frequency F00.19 to maximum frequency F14.78	Hz	50	●	0x0E4F

See F00.16 and F00.18

Function code	Function code name	Parameter description	Unit	Default setting	Attribute	Mailing address
F14.80	V/F curve setting of motor 2	0: straight line V/F 1: multi-point broken line V/F 2: 1.3-power V/F 3: 1.7-power V/F 4: square V/F 5: VF complete separation mode ( $U_d = 0, U_q = K * t$ = voltage of separation voltage source) 6: VF semi-separation mode ( $U_d = 0, U_q = K * t = F/Fe * 2 * \text{voltage of separation voltage source}$ )		0	○	0x0E50
F14.81	Multi-point VF frequency F1 of motor 2	0.00 ~ F14.83	Hz	0.50	●	0x0E51
F14.82	Multi-point VF voltage V1 of motor 2	0.0~100.0 (100.0 = Rated voltage)	%	1.0	●	0x0E52
F14.83	Multi-point VF frequency F2 of motor 2	F14.81 ~ F14.85	Hz	2.00	●	0x0E53
F14.84	Multi-point VF voltage V2 of motor 2	0.0~100.0	%	4.0	●	0x0E54



F14.85	Multi-point VF frequency F3 of motor 2	F14.83 to rated frequency of motor (reference frequency)	Hz	5.00	●	0x0E55
F14.86	Multi-point VF voltage V3 of motor 2	0.0~100.0	%	10.0	●	0x0E56

See F05.00 to F05.06

Function code	Function code name	Parameter description	Unit	Default setting	Attribute	Mailing address
F14.87	Stop mode of motor 2	0: slow down to stop 1: free stop		0	○	0x0E57

See F04.19

## 7.16 Auxiliary Function Parameter Group of F15 Group

Function code	Function code name	Parameter description	Unit	Default setting	Attribute	Mailing address
F15.00	Jog frequency	0.00 to maximum frequency F00.16	Hz	5.00	●	0x0F00
F15.01	Jog acceleration time	0.00 ~ 650.00 (F15.13=0) 0.0 ~ 6500.0 (F15.13=1) 0 ~ 65000 (F15.13=2)	s	5.00	●	0x0F01
F15.02	Jog deceleration time	0.00 ~ 650.00 (F15.13=0) 0.0 ~ 6500.0 (F15.13=1) 0 ~ 65000 (F15.13=2)	s	5.00	●	0x0F02

As shown in Fig. 7-32, when the jog running command (FJOG/RJOG) is valid, the inverter will start running at the set frequency of F15.00; and when the jog running command is invalid, the inverter will be stopped according to the stop mode.

F15.01 and F15.02 are set as the acceleration and deceleration time during operation. Their values (e.g. 500) depend on the acceleration and deceleration time unit (F15.13), and have different meanings and ranges. For example, F15.13=0 means that the acceleration and deceleration time is 5.00s, and F15.13=1 means that the acceleration and deceleration time is 50.0s.

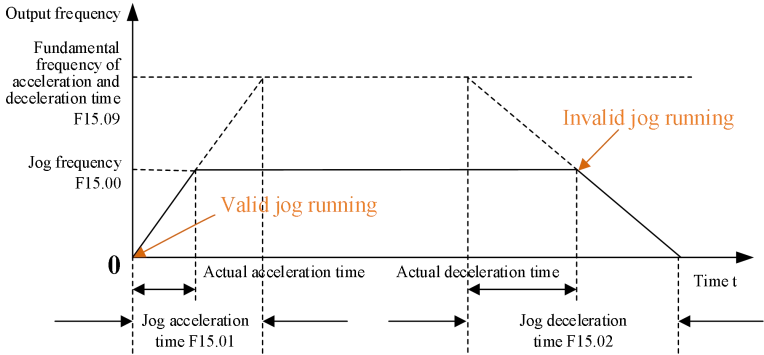

Fig. 7-32 Schematic Diagram of Jog Running

★: The separate set frequency and acceleration/deceleration time are applied in jog running, and not shared in normal running, but with the same physical meanings.

The triggering conditions of the jog running command vary depending on the control mode and valid conditions, as detailed in Table 7-22.

Table 7-22 Details of Jog Running Command

Command Source Option (F00.02)	Jog running command
1: Terminal control	Select the digital input terminal function “4: forward jog (FJOG)” or “5: reverse jog (RJOG)”. By default, if the function terminal is valid, the jog running command will be valid; and if the function terminal is invalid, the jog running command will be invalid.
2: Communication control	If the host writes “0003H: JOG forward” or “0004: JOG reverse” to the register 7000H through the MODBUS protocol, the jog running command will be valid; if it writes “0007H: free stop”, the jog running command will be invalid.

Function code	Function code name	Parameter description	Unit	Default setting	Attribute	Mailing address
F15.03	Acceleration time 2	0.00 ~ 650.00 (F15.13=0) 0.0 ~ 6500.0 (F15.13=1) 0 ~ 65000 (F15.13=2)	s	15.00	●	0x0F03
F15.04	Deceleration time 2	0.00 ~ 650.00 (F15.13=0)	s	15.00	●	0x0F04

		0.0 ~ 6500.0 (F15.13=1) 0 ~ 65000 (F15.13=2)				
F15.05	Acceleration time 3	0.00 ~ 650.00 (F15.13=0) 0.0 ~ 6500.0 (F15.13=1) 0 ~ 65000 (F15.13=2)	s	15.00	●	0x0F05
F15.06	Deceleration time 3	0.00 ~ 650.00 (F15.13=0) 0.0 ~ 6500.0 (F15.13=1) 0 ~ 65000 (F15.13=2)	s	15.00	●	0x0F06
F15.07	Acceleration time 4	0.00 ~ 650.00 (F15.13=0) 0.0 ~ 6500.0 (F15.13=1) 0 ~ 65000 (F15.13=2)	s	15.00	●	0x0F07
F15.08	Deceleration time 4	0.00 ~ 650.00 (F15.13=0) 0.0 ~ 6500.0 (F15.13=1) 0 ~ 65000 (F15.13=2)	s	15.00	●	0x0F08
F15.09	Fundamental frequency of acceleration and deceleration time	0: maximum frequency F00.16 1: 50.00Hz 2: set frequency		0	○	0x0F09

The system has four groups (F00.14 and F00.15 in the first group) of acceleration and deceleration time options to meet different needs for normal operation. After completing the setting, the user can switch them via the combination of digital input functions “19: acceleration and deceleration time terminal 1” and “20: acceleration and deceleration time terminal 2”. For details, please see: Table 7-6 Function List of Multi-function Digital Input Terminals.

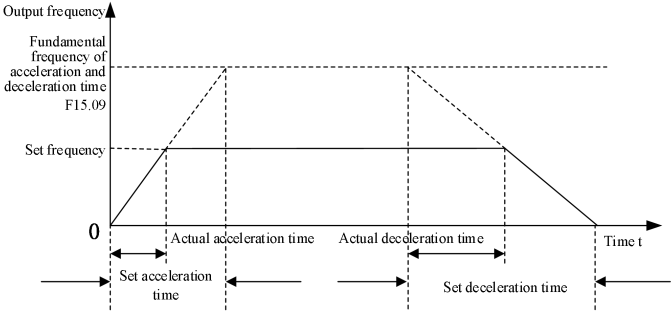

Fig. 7-33 Schematic Diagram of Acceleration and Deceleration Time

As shown in Fig. 7-33, the acceleration time is defined as the time of acceleration from 0.00 Hz to the reference frequency of acceleration/deceleration time; and the deceleration time is defined as the time of deceleration from the reference frequency of acceleration/deceleration time to 0.00 Hz. The actual acceleration/deceleration time varies according to the ratio between the set frequency and reference frequency.

The reference frequency of acceleration/deceleration time is set by function code F15.09 that represents the reference frequency of acceleration/deceleration time. If F15.09=0, the reference frequency depends on the function code F00.16 (maximum frequency). Assuming F00.16=100.00Hz, the acceleration (deceleration) time is expressed as the time for the output frequency to increase (decrease) from 0.00Hz (100.00Hz) to 100.00Hz (0.00Hz). If F15.09=2, the reference frequency depends on the function code F18.01 (set frequency). Assuming F18.01=100.00Hz, the acceleration (deceleration) time is expressed as the time for the output frequency to increase (decrease) from 0.00Hz (100.00Hz) to 100.00Hz (0.00Hz).

Function code	Function code name	Parameter description	Unit	Default setting	Attribute	Mailing address
F15.10	Automatic switching of acceleration and deceleration time	0: invalid 1: valid		0	○	0x0F0A
F15.11	Switching frequency of acceleration time 1 and 2	0.00 to maximum frequency F00.16	Hz	0.00	●	0x0F0B
F15.12	Switching frequency of deceleration time 1 and 2	0.00 to maximum frequency F00.16	Hz	0.00	●	0x0F0C

If the motor 1 is running at the normal (e.g. non-PLC/PID) speed (e.g. non-torque) and the acceleration/deceleration time terminals (19: acceleration and deceleration time terminal 1; 20: acceleration and deceleration time terminal 2) are invalid, the acceleration/deceleration time 1 and acceleration/deceleration time 2 can be switched by setting F15.10 to 1, as detailed in Fig. 7-34.

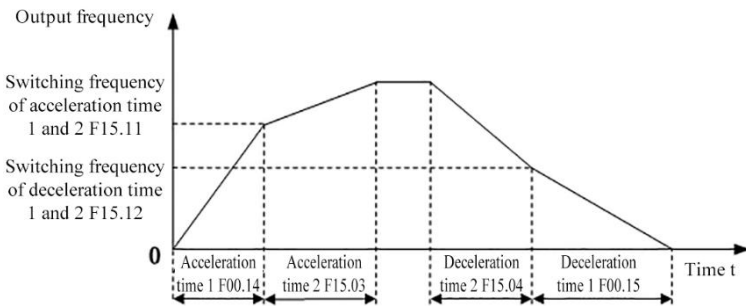

Fig. 7-34 Schematic Diagram of Automatic Switching of Acceleration and Deceleration Time

During acceleration, if the output frequency is less than the switching frequency of the acceleration time 1 and 2 (F15.11), the acceleration time 1 will be the current valid acceleration

time; otherwise, the acceleration time 2 will be the current valid acceleration time.

During deceleration, if the output frequency is less than the switching frequency of the deceleration time 1 and 2 (F15.12), the deceleration time 1 will be the current valid deceleration time; otherwise, the deceleration time 2 will be the current valid deceleration time.

Function code	Function code name	Parameter description	Unit	Default setting	Attribute	Mailing address
F15.13	Acceleration and deceleration time unit	0:0.01s 1:0.1s 2:1s		0	○	0x0F0D

Under different working conditions, the acceleration and deceleration time requirements may vary greatly. The system provides three acceleration and deceleration time units, depending on the function code F15.13. F15.13=1 means that the acceleration/deceleration time unit is “0.1s”. Except for that in torque control (F13.06), all the acceleration and deceleration time will change. For example, the value of F00.14 will change from 15.00s to 150.0s by default.

Function code	Function code name	Parameter description	Unit	Default setting	Attribute	Mailing address
F15.14	Frequency hopping point 1	0.00~600.00	Hz	600.00	●	0x0F0E
F15.15	Hopping range 1	0.00~20.00, 0.00 is invalid	Hz	0.00	●	0x0F0F
F15.16	Frequency hopping point 2	0.00~600.00	Hz	600.00	●	0x0F10
F15.17	Hopping range 2	0.00~20.00, 0.00 is invalid	Hz	0.00	●	0x0F11
F15.18	Frequency hopping point 3	0.00~600.00	Hz	600.00	●	0x0F12
F15.19	Hopping range 3	0.00~20.00, 0.00 is invalid	Hz	0.00	●	0x0F13

The frequency hopping function (FH function for short) can prevent the output frequency of the inverter from the mechanical resonance frequency point of the mechanical load. If the inverter is prohibited from running at a constant speed within the frequency hopping range, hopping will not occur during acceleration. Instead, the inverter will run smoothly.

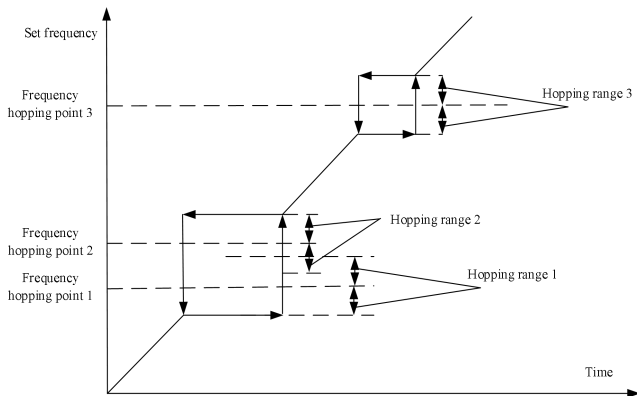

Fig. 7-35 Schematic Diagram of Frequency Hopping

As shown in Fig. 7-35, the frequency hopping function is set in the form of “frequency hopping point + hopping range”. The specific frequency hopping range is (frequency hopping point - hopping range, frequency hopping point + hopping range). At most three frequency hopping areas can be set. When the respective hopping range is 0, the corresponding frequency hopping function will be invalid.

When the frequency hopping function is valid and the set frequency rises within the regulation range, the final set frequency is “frequency hopping point - hopping range”; and when the frequency hopping function drops, the final set frequency is “frequency hopping point + hopping range”.

Multiple frequency hopping areas can be superimposed, as shown in the frequency hopping areas 1 and 2 in Fig. 7-35. The final frequency hopping range is (frequency hopping point 1 - hopping range 1, frequency hopping point 2 + hopping range 2).

Function code	Function code name	Parameter description	Unit	Default setting	Attribute	Mailing address
F15.20	Detection width of output frequency arrival (FAR)	0.00 ~ 50.00	Hz	2.50	○	0x0F14

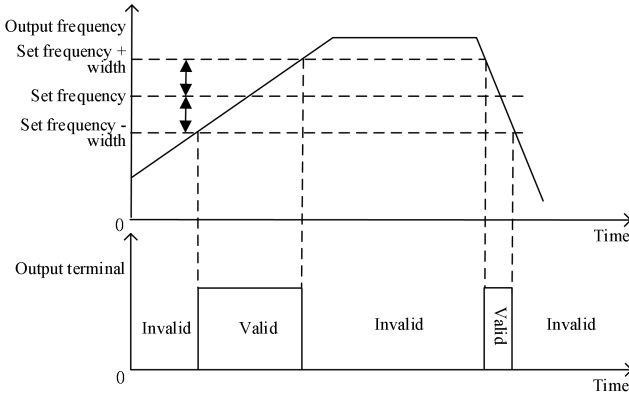

Fig. 7-36 Schematic Diagram of FAR Detection

As shown in Fig. 7-36, when the multi-function output terminal or relay output is set to “2: up to output frequency (FAR)”, and the absolute value of the difference between the |output frequency| and |given frequency| is less than or equal to the set value of FAR detection width (F15.20) during inverter operation, the corresponding function terminal will output the active level. Otherwise, this terminal will output the inactive level.

Function code	Function code name	Parameter description	Unit	Default setting	Attribute	Mailing address
F15.21	Output frequency detection FDT1	0.00 to maximum frequency F00.16	Hz	30.00	○	0x0F15
F15.22	FDT1 hysteresis	-(Fmax-F15.21)~F15.21	Hz	2.00	○	0x0F16
F15.23	Output frequency detection FDT2	0.00 to maximum frequency F00.16	Hz	20.00	○	0x0F17
F15.24	FDT2 hysteresis	-(Fmax-F15.23)~F15.23	Hz	2.00	○	0x0F18

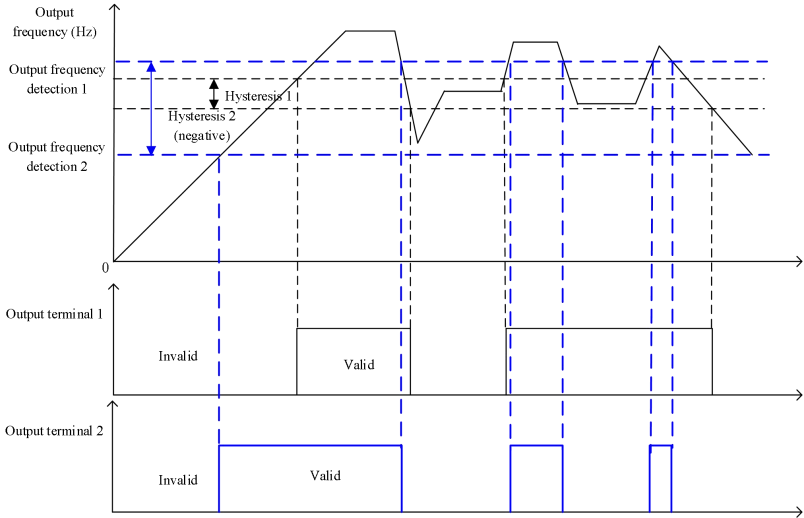

Fig. 7-37 Schematic Diagram of FDT Detection

As shown in Fig. 7-37, when the multi-function output terminal or relay output is set to “3: output frequency detection FDT1” or “4: output frequency detection FDT2” and the inverter is running:

1. If the hysteresis is positive and the |output frequency| is greater than the result of “output frequency detection FDT1/2” (F15.21/F15.23), the corresponding function terminal will output the active level; if the |output frequency| drops to less than the result of “output frequency detection FDT1/2 (F15.21/F15.23) - FDT1/2 hysteresis (F15.22/F15.24)”, the corresponding function terminal will output the inactive level; and if the |output frequency| is within the range of (output frequency detection - hysteresis, output frequency detection), the output level of the corresponding function terminal will remain unchanged.

2. If the hysteresis is negative and the |output frequency| is greater than the result of “output frequency detection FDT1/2” (F15.21/F15.23), the corresponding function terminal will output the active level; if the |output frequency| drops to less than the result of “output frequency detection FDT1/2 (F15.21/F15.23) - FDT1/2 hysteresis (F15.22/F15.24)”, the corresponding function terminal will output the inactive level; and if the |output frequency| is within the range



of (output frequency detection, output frequency detection - hysteresis,), the output level of the corresponding function terminal will remain unchanged.

Function code	Function code name	Parameter description	Unit	Default setting	Attribute	Mailing address
F15.25	Options of analog level detection ADT	0: AI1 1: AI2		0	○	0x0F19
F15.26	Analog level detection ADT1	0.00~100.00	%	20.00	●	0x0F1A
F15.27	ADT1 hysteresis	0.00 to F15.26 (valid down in one direction)	%	5.00	●	0x0F1B
F15.28	Analog level detection ADT2	0.00~100.00	%	50.00	●	0x0F1C
F15.29	ADT2 hysteresis	0.00 to F15.28 (valid down in one direction)	%	5.00	●	0x0F1D

The analog level detection function is used to detect and monitor the analog input of the current selected F15.25 channel, and also perform internal operation and external alarm monitoring. Two detection conditions can be set, but only one analog input channel can be detected.

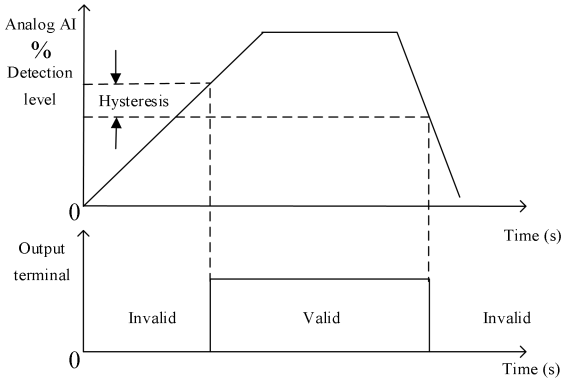

Fig. 7-38 Schematic Diagram of ADT Detection

As shown in Fig. 7-38, a valid starting point has been set for the detection level. When the percentage of analog input is above the detection level after offset processing, the ADT function will be valid. The conditions for invalid ADT function are dependent on the one-way downward hysteresis. When the conversion result of analog input decreases to less than the result of

“detection level - hysteresis”, the ADT function will be invalid.

Function code	Function code name	Parameter description	Unit	Default setting	Attribute	Mailing address
F15.30	Options of energy consumption braking function	0: invalid 1: valid		0	○	0x0F1E
F15.31	Energy consumption braking voltage	110.0~140.0 (380V, 100.0 = 537V)	%	125.0(671V)	○	0x0F1F
F15.32	Braking rate	20~100 (100 means that duty ratio is 1)	%	100	●	0x0F20

Energy consumption braking is a braking method for quick deceleration by converting the energy generated in deceleration into the thermal energy of the braking resistor. It is suitable for braking under large-inertia loads or stop by rapid braking. In this case, it is necessary to select the appropriate braking resistor and braking unit, as detailed in 10.1 Braking Resistor and 10.2 Braking unit.

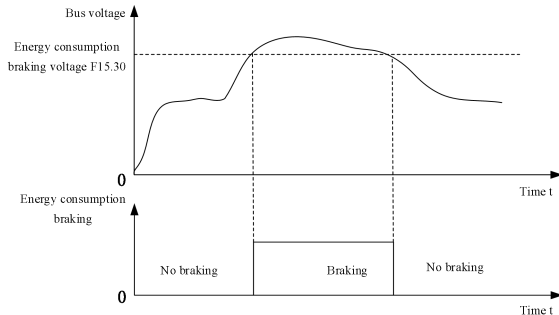

Fig. 7-39 Schematic Diagram of Energy Consumption Braking

In the case of valid energy consumption braking (F15.30=1), as shown in Fig. 7-39, when the bus voltage is greater than the energy consumption braking voltage (F15.31), energy consumption braking will be started; and when the bus voltage decreases to less than the aforesaid value, energy consumption braking will be disabled.

The IGBT in the braking unit is engaged during energy consumption braking. Energy can be quickly released by the braking resistor. The braking utilization rate (F15.32) is the duty cycle of IGBT running. The greater the duty cycle, the larger the degree of braking is.

Function code	Function code name	Parameter description	Unit	Default setting	Attribute	Mailing address
F15.33	Operating mode with set frequency less than lower frequency limit	0: running at the lower frequency limit 1: shutdown		0	○	0x0F21

When the set frequency of the inverter is lower than the lower frequency limit (F00.19), the running status depends on the function code F15.33.

Function code	Function code name	Parameter description	Unit	Default setting	Attribute	Mailing address
F15.34	Fan control	Ones place: fan control mode 0: running after power-on 1: running at startup 2: intelligent operation, subject to temperature control Tens place: power on fan control 0: run for 1 minute and then run in fan control mode 1: directly operate in fan control mode Hundreds place: Fan low speed mode enable (above 280kW) 1: the operation at low speed is invalid 2: low speed operation is valid		101	○	0x0F22

In order to use the fan reasonably, the fan system has three running modes, depending on the fan control function code (F15.34). The specific running mode of the fan is shown in Table 7-23.

Table 7- 23 Details of Fan Operation

Fan control	Fan operation
0: running after power-on	When the inverter is powered on, the fan will start running.
1: running at startup	When the inverter starts running, the fan will start running. When this parameter is set to 1 min, the fan will stop running.
2: intelligent operation, subject to temperature control	When the temperature of the inverter is greater than 45 °C, the fan will start running; when the temperature of the inverter is less than 40 °C, the fan will stop running; and when the temperature of the inverter is in between the two values, the fan will remain unchanged.

- ★ When “2: intelligent operation, subject to temperature control” is selected, make sure that the temperature detection module of the inverter works properly.

Function code	Function code name	Parameter description	Unit	Default setting	Attribute	Mailing address
F15.35	Overmodulation intensity	1.00 ~ 1.10		1.05	●	0x0F23

When the input voltage of the inverter is lower than the output voltage, you can increase the overmodulation intensity to improve the bus voltage utilization and thus increase the upper limit of output voltage. When F15.35=1.10, the upper limit of output voltage can be increased by 10%, thus reducing the output current under heavy loads, but the current harmonics will increase.

Function code	Function code name	Parameter description	Unit	Default setting	Attribute	Mailing address
F15.36	Switching options of PWM modulation mode	0: invalid (7-segment PWM modulation) 1: valid (5-segment PWM modulation)		0	○	0x0F24
F15.37	Switching frequency of PWM modulation mode	0.00 to maximum frequency F00.16	Hz	15.00	●	0x0F25

When the PWM modulation mode is invalid (F15.36=0), the 7-segment PWM modulation will be enabled. When the WM modulation mode is valid (F15.36=1), the 7-segment PWM modulation will be enabled at the output frequency lower than the switching frequency (F15.37) and the 5-segment PWM modulation will be enabled at the output frequency higher than the switching frequency. The 7-segment PWM modulation has a smaller current ripple than 5-segment PWM modulation, but involves larger switching loss, more heat from the inverter, and larger temperature rise.

Function code	Function code name	Parameter description	Unit	Default setting	Attribute	Mailing address
F15.38	Options of dead zone compensation mode	0: no compensation 1: compensation mode 1 2: compensation mode 2		1	○	0x0F26

This parameter does not need to change under normal circumstances in the dead zone compensation mode. Users need to select a different compensation mode only in case of special requirements for the quality of the output voltage waveform or other abnormalities (e.g. motor oscillation).

The compensation mode 1 is often selected. If the motor is prone to oscillation at high power and under VF control, the compensation mode 2 may be selected.

Function code	Function code name	Parameter description	Unit	Default setting	Attribute	Mailing address
F15.39	Terminal jog priority	0: invalid 1: valid		0	○	0x0F27

In the terminal control mode (F00.02=1), this function code is used to set the highest priority of the jog command. If the terminal jog priority is valid (F15.39=1), the running status can be switched to jog running in the presence of a valid jog terminal; and if the terminal jog priority is invalid (F15.39=0), the running status cannot be directly switched to jog running.

Function code	Function code name	Parameter description	Unit	Default setting	Attribute	Mailing address
F15.40	Deceleration time for quick stop	0.00 ~ 650.00 (F15.13=0) 0.0 ~ 6500.0 (F15.13=1) 0 ~ 65000 (F15.13=2)	s	1.00	●	0x0F28

Set the acceleration and deceleration time during rapid stop.

Function code	Function code name	Parameter description	Unit	Default setting	Attribute	Mailing address
F15.55	The current reaches the measured value	0.0~300.0 (100.0% corresponding to rated motor current)	%	100	●	0x0F37
F15.56	The current reaches the hysteresis	0.0~F15.44	%	5	●	0x0F38
F15.57	Torque reaches test value	0.0~300.0 (100.0% corresponding to rated motor torque)	%	100	●	0x0F39
F15.58	The torque reaches the hysteresis ring	0.0~F15.46	%	5	●	0x0F3A

**Current reached:**

In the running state, the output current > the current reaches the tested value (F15.44), and the current output is valid.

In the Non-running state, the output current ≤ current to test value (F15.44) - CDT

hysteresis (F15.45), the current output is invalid;

Otherwise, the current output status does not change. The terminal remains in the upper state between the current reaching the tested value (F15.44) - CDT hysteresis (F15.45) and the current reaching the tested value (F15.44).

**Torque reached:**

In the running state, | the output torque | is greater than | the torque reaches the tested value (F15.44) |, the current output is valid.

In the Non-running state, | the output torque | is less and equal than | the torque reaches the tested value (F15.44) | - the TDT hysteresis (F15.47), the current output is invalid;

Otherwise, the current output status does not change. The terminal remains in the upper state between torque arrival test value (F15.46) - TDT hysteresis (F15.47) and torque arrival test value (F15.46).

Function code	Function code name	Parameter description	Unit	Default setting	Attribute	Mailing address
F15.62	PG card feedback frequency display filtering time	0~20000	ms	300	●	0x0F3E
F15.63	The speed reaches the limit of rise	0.00~Fmax	Hz	30	●	0x0F3F
F15.64	The speed reaches filtering time	0~60000	ms	500	●	0x0F40
F15.65	The speed reaches the limit of descent	0.00~Fmax	Hz	0	●	0x0F41

**Speed reached:**

In the acceleration state, the output frequency is greater than the speed reaching the rising limit (F15.63), and the current output is valid;

In the deceleration state, the output frequency is less than the speed reaches the descent limit (F15.65), and the current output is invalid.

Increasing F15.64 can increase anti-interference ability, prevent misoperation, and increase the delay of output terminal action.

Set the filtering time

Function code	Function code name	Parameter description	Unit	Default setting	Attribute	Mailing address
F15.66	Overcurrent detection level	0.1~300.0 (0.0: no detection; 100.0%: corresponding to the rated current of motor)	%	200.0	●	0x0F42
F15.67	Overcurrent detection delay time	0.00~600.00	s	0.00	●	0x0F43

When the current exceeds the overcurrent detection level (F15.66) and the duration reaches F15.67, the function “73: output overcurrent” of the output terminal will be valid.

Function code	Function code name	Parameter description	Unit	Default setting	Attribute	Mailing address
F15.68	Market price	0.00~100.00		1.00	○	0x0F44

Set the current electricity price in the market and calculate the electricity savings. The electricity savings can be viewed by the function codes F18.69 and F18.70.

Function code	Function code name	Parameter description	Unit	Default setting	Attribute	Mailing address
F15.69	Power-frequency load factor	30.0~200.0	%	90.0	○	0x0F45

Set the coefficient of the power frequency load.

### 7.17 F16 customized function parameter group

Function code	Function code name	Parameter description	Unit	Default setting	Attribute	Mailing address
F16.00	Industry application	0: universal model 1: water supply application 2: air compressor application 3: winding application 4: fan application 5: spindle application of machine tool 6: polishing machine application 7: high-speed motor application 8: plastic extruding machine 9: EM100 comm macro		0	○	0x1000

		10: EM303B comm macro				
--	--	-----------------------	--	--	--	--

**F16.00=0: general model**

Since the inverter is a general-purpose product, relevant functions for each application should not be enabled.

**F16.00=1: water supply application**

Since the inverter is a PID-regulated constant-pressure water supply control product, a clock option can be provided for clock pressure setting.

**F16.00=2: Air compressor application**

Since the inverter is a dedicated PID-regulated control product for air compressors, an air compressor interface option can be provided for PT100 automatic temperature calculation and the like.

Function code	Function code name	Parameter description	Unit	Default setting	Attribute	Mailing address
F00.04	Main frequency source A selection	0: Digital frequency given F00.07 1: AI1 2: AI2 5: High frequency pulse input (X5) 6: Main frequency communication given (percentage) 7: Main frequency communication given (direct frequency setting) 8: Digital potentiometer given		2	○	0x0004
F00.14	Acceleration time 1	0.00~650.00 (F15.13=0) 0.0~6500.0 (F15.13=1) 0~65000 (F15.13=2)	s	25.00	●	0x000E
F00.15	Deceleration time 1	0.00~650.00 (F15.13=0)	s	30.00	●	0x000F



		0.0~6500.0 (F15.13=1) 0~65000 (F15.13=2)				
F00.19	Lower frequency	0.00~Upper frequency limit F00.18	Hz	30.00	●	0x0013
F00.21	Inversion of Control	0: Allow forward/reverse rotation 1: Disable reverse rotation		1	○	0x0015
F00.24	Automatic adjustment of carrier frequency	0: Invalid 1: Valid 1 2: Valid 2		0	○	0x0018
F02.01	X2 Digital input function selection	See the input terminal function table for details.		9	○	0x0201
F02.37	Curve 2 Minimum Input	-10.00~F02.39	V	2.10	●	0x0225

### F16.00=3: Winding application

The inverter is a dedicated PID-regulated control product for winding and unwinding.

### F16.00=4: Fan application

The inverter can be used to configure the parameters of the corresponding function code for the fan application macro.

Function code	Function code name	Parameter description	Unit	Default setting	Attribute	Mailing address
F00.02	Command source selection	0: Keyboard control (LOC/REM light on) 1: Terminal control (LOC/REM light off) 2: Communication control (LOC/REM light flashing)		1	○	0x0002
F00.04	Main frequency source A selection	0: Digital frequency given F00.07 1: AI1 2: AI2 5: High frequency pulse input (X5)		2	○	0x0004

		6: Main frequency communication given (percentage) 7: Main frequency communication given (direct frequency setting) 8: Digital potentiometer given				
F00.14	Acceleration time 1	0.00~650.00 (F15.13=0) 0.0~6500.0 (F15.13=1) 0~65000 (F15.13=2)	s	25.00	●	0x000E
F00.15	Deceleration time 1	0.00~650.00 (F15.13=0) 0.0~6500.0 (F15.13=1) 0~65000 (F15.13=2)	s	30.00	●	0x000F
F00.21	Inversion of Control	0: Allow forward/reverse rotation 1: Disable reverse rotation		1	○	0x0015
F00.30	Model selection	0: G type machine 1: P type machine		1	○	0x001E
F02.01	X2 Digital input function selection	See the input terminal function table for details.		24	○	0x0201
F02.02	X3 Digital input function selection	See the input terminal function table for details.		9	○	0x0202
F04.00	Startup method	0: Direct start 1: Speed tracking start		1	○	0x0400
F04.08	Speed tracking method	Units: Tracking start frequency 0: Maximum frequency 1: Stop frequency 2: Power frequency		11D	○	0x0408

		Tens: Search direction selection 0: Search only in the command direction 1: Search in the reverse direction if no speed is found in the command direction				
F04.19	Parking options	0: deceleration stop 1: free stop		1	○	0x0413
F05.00	V/F curve setting	0: Straight line V/F 1: Multi-point broken line V/F 2: 1.3 power V/F 3: 1.7 power V/F 4: Square V/F 5: VF complete separation mode ( $U_d=0$ , $U_q=K*t=$ separation voltage source voltage) 6: VF semi-separation mode ( $U_d=0$ , $U_q=K*t=F/Fe*2*$ separation voltage source voltage)		4	○	0x0500
F07.06	Bus voltage control selection	Units: Instantaneous stop without stopping function selection 0: Invalid 1: Deceleration 2: Deceleration stop Tens: Overvoltage stall function selection 0: Invalid 1: Valid		11	○	0x0706
F07.14	Failure retry times	0~20, 0: Disable fault retry		5	○	0x070E
F07.16	Failure retry interval	0.01~30.00	s	30.00	●	0x0710

F17.01	VX2 virtual input function selection	Same as F02 group, digital input terminal function selection		51	○	0x1101
F17.28	Virtual output terminal control selection	D7 D6 D5 D4 D3 D2 D1 D0 VY8 VY7 VY6 VY5 VY4 VY3 VY2 VY1 0: Determined by the status of X1~X5 terminals 1: Determined by the output function status		11111101 B	○	0x111C

**F16.00=5: Machine tool spindle application**

The inverter can be used to configure the parameters of the corresponding function code for the application micro of machine tool spindle.

Function code	Function code name	Parameter description	Unit	Default setting	Attribute	Mailing address
F00.01	Motor 1 drive control mode	0: V/F control (VVF) 1: Speed sensorless vector control (SVC)		0		0x0001
F00.02	Command source selection	0: Keyboard control (LOC/REM light on) 1: Terminal control (LOC/REM light off) 2: Communication control (LOC/REM light flashing)		1	○	0x0002
F00.03	Terminal control mode selection	0: Terminal RUN, F/R forward/reverse 1: Terminal RUN, F/R reverse 2: Terminal RUN, Xi forward, F/R reverse 3: Terminal RUN, Xi stop, F/R		1		0x0003

		forward/reverse				
F00.04	Main frequency source A selection	0: Digital frequency given F00.07 1: AI1 2: AI2 5: High frequency pulse input (X5) 6: Main frequency communication given (percentage) 7: Main frequency communication given (direct frequency setting) 8: Digital potentiometer given		2	○	0x0004
F00.14	Acceleration time 1	0.00~650.00 (F15.13=0) 0.0~6500.0 (F15.13=1) 0~65000 (F15.13=2)	s	2.00	●	0x000E
F00.15	Deceleration time 1	0.00~650.00 (F15.13=0) 0.0~6500.0 (F15.13=1) 0~65000 (F15.13=2)	s	2.00	●	0x000F
F00.16	Maximum frequency	1.00Hz~600.00	Hz	100.00	○	0x0010
F00.18	Upper frequency	Lower frequency limit F00.19~maximum frequency F00.16	Hz	100.00	●	0x0012
F07.06	Bus voltage control selection	Units: Instantaneous stop without stopping function selection 0: Invalid 1: Deceleration 2: Deceleration stop Tens: Overvoltage stall		0	○	0x0706

		function selection 0: Invalid 1: Valid				
F07.27	AVR Features	0: Invalid 1: Valid 2: Automatic		2	○	0x071B
F15.30	Dynamic braking function selection	0: Invalid 1: Valid		1	○	0x0F1E
F15.31	Dynamic braking action voltage	110.0~140.0 (380V,100.0=537V)	%	132.0	○	0x0F1F

### F16.00=6: Polishing machine application

The inverter can be used to configure the parameters of the corresponding function code for the extruder application macro.

Function code	Function code name	Parameter description	Unit	Default setting	Attribute	Mailing address
F00.02	Command source selection	0: Keyboard control (LOC/REM light on) 1: Terminal control (LOC/REM light off) 2: Communication control (LOC/REM light flashing)		1	○	0x0002
F00.04	Main frequency source A selection	0: Digital frequency given F00.07 1: AI1 2: AI2 5: High frequency pulse input (X5) 6: Main frequency communication given (percentage) 7: Main frequency communication given (direct frequency setting) 8: Digital potentiometer		2	○	0x0004

		given				
F00.14	Acceleration time 1	0.00~650.00 (F15.13=0) 0.0~6500.0(F15.13=1) 0~65000 (F15.13=2)	s	2.00	●	0x000E
F00.15	Deceleration time 1	0.00~650.00 (F15.13=0) 0.0~6500.0(F15.13=1) 0~65000 (F15.13=2)	s	2.00	●	0x000F
F00.16	Maximum frequency	1.00Hz~600.00	Hz	100.00	○	0x0010
F00.18	Upper frequency	Lower frequency limit F00.19~maximum frequency F00.16	Hz	100.00	●	0x0012
F10.01	Modbus communication baud rate	0: 4800 1: 9600 2: 19200 3: 38400 4: 57600 5: 115200		2	○	0x0A01
F10.02	Modbus Data Format	0: 1-8-N-1 (1 start bit + 8 data bits + 1 stop bit) 1: 1-8-E-1 (1 start bit + 8 data bits + 1 even parity + 1 stop bit) 2: 1-8-O-1 (1 start bit + 8 data bits + 1 odd parity + 1 stop bit) 3: 1-8-N-2 (1 start bit + 8 data bits + 2 stop bits) 4: 1-8-E-2 (1 start bit + 8 data bits + 1 even parity + 2 stop		1	○	0x0A02

		bits) 5: 1-8-O-2 (1 start bit + 8 data bits + 1 odd parity + 2 stop bits)				
--	--	--	--	--	--	--

**F16.00=7: High-speed motor application**

The inverter can be used to configure the parameters of the corresponding function code for the high-speed motor application macro.

Function code	Function code name	Parameter description	Unit	Default setting	Attribute	Mailing address
F00.01	Motor 1 drive control mode	0: V/F control (VVF) 1: Speed sensorless vector control (SVC)		0	○	0x0001
F00.31	Frequency resolution	0:0.01Hz 1:0.1Hz (speed unit is 10rpm)		1	○	0x001F
F00.23	Carrier frequency	1.0~16.0 (inverter rated power 0.75~4.00kW) 1.0~10.0 (inverter rated power 5.50~7.50kW) 1.0~8.0 (inverter rated power 11.00~55.00kW) 1.0~6.0 (inverter rated power 75.00~160.00kW) 1.0~2.0 (inverter rated power 185.00~450.00kW)	kHz	8	●	0x0017
F00.24	Main frequency source A selection	0: Digital frequency given F00.07 1: AI1 2: AI2 5: High frequency pulse input (X5) 6: Main frequency		2	○	0x0018



		communication given (percentage) 7: Main frequency communication given (direct frequency setting) 8: Digital potentiometer given				
F05.10	V/F stator voltage drop compensation gain	0.00~200.00	%	0.00	●	0x050A
F05.11	V/F slip compensation gain	0.00~200.00	%	0.00	●	0x050B
F07.00	Protection Shield	E20 E22 E13 E06 E05 E04 E07 E08 0: Protection is effective 1: Protection is blocked		00000001	○	0x0700
F15.42	Output current display coefficient	50.00~150.00	%	80.00	●	0x0F2A

**F16:00=8: Plastic extruding machine**

The inverter can be used to configure the parameters of the corresponding function code for the plastic extruding machine application macro.

Function code	Function code name	Parameter description	Unit	Default setting	Attribute	Mailing address
F00.03	Terminal control mode selection	0: Terminal RUN, F/R forward/reverse 1: Terminal RUN, F/R reverse 2: Terminal RUN, Xi forward, F/R reverse 3: Terminal RUN, Xi stop, F/R forward/reverse		1		0x0003
F00.04	Main frequency source A selection	0: Digital frequency given F00.07 1: All		2	○	0x0004

		2: AI2 5: High frequency pulse input (X5) 6: Main frequency communication given (percentage) 7: Main frequency communication given (direct frequency setting) 8: Digital potentiometer given				
F00.14	Acceleration time 1	0.00~650.00 (F15.13=0) 0.0~6500.0 (F15.13=1) 0~65000 (F15.13=2)	s	2.00	●	0x000E
F00.15	Deceleration time 1	0.00~650.00 (F15.13=0) 0.0~6500.0 (F15.13=1) 0~65000 (F15.13=2)	s	2.00	●	0x000F
F02.02	X3 Digital input function selection	See the input terminal function table for details.		23	○	0x0202
F05.00	V/F curve setting	0: Straight line V/F 1: Multi-point broken line V/F 2: 1.3 power V/F 3: 1.7 power V/F 4: Square V/F 5: VF complete separation mode (Ud=0, Uq=K*t=separation voltage source voltage) 6: VF semi-separation mode (Ud=0, Uq=K*t=F/Fe*2*separation voltage source		1	○	0x0500

		voltage)				
F05.02	Multi-point VF Voltage point V1	0.0~100.0 (100.0=rated voltage)	%	2.0	●	0x0502
F05.04	Multi-point VF Voltage point V2	0.0~100.0	%	5.5	●	0x0504
F05.10	V/F stator voltage drop compensation gain	0.00~200.00	%	0.00	●	0x050A
F05.11	V/F slip compensation gain	0.00~200.00	%	0.00	●	0x050B

**F16:00=9: EM100 comm macro**

The inverter can be used to configure the parameters of the corresponding function code for the EM100 comm macro. When the original EM100 model is used and Modbus communication function is set to F16.00=9, EM100 can be directly replaced without changing the PLC program of the customer. Common communication functions can be met, including write frequency, read output current, output frequency, and the running status of the inverter.

**F16:00=10: EM303B comm macro**

The inverter can be used to configure the parameters of the corresponding function code for the EM303B comm macro. The original EM303B model and Modbus communication function is set to F16.00=10, EM303B can be directly replaced without changing the customer PLC program, common communication functions can be met, including write frequency, read output current, output frequency, and frequency converter running state;

Function code	Function code name	EM100 communication Macro current value	EM100 communication macro address Corresponding function code	EM303B communication macro current value	EM303B Communication macro address corresponding function code	Attribute
F00.04	Main frequency source A selection	0		0		○

F45.00	Modbus communication free mapping enabled	1		1		●
F45.01	Source Address 1	7	F00.07 (0007H)	7	F00.07(0007H)	●
F45.02	Destination Address 1	32775	F00.07 (8007H)	32775	F00.07(8007H)	●
F45.04	Source Address 2	8199	F00.07 (2007H)	8199	F00.07(2007H)	●
F45.05	Destination Address 2	32775	F00.07 (8007H)	32775	F00.07(8007H)	●
F45.07	Source Address 3	16384	4000H	16384	4000H	●
F45.08	Destination Address 3	28672	7000H	28672	7000H	●
F45.10	Source Address 4	9	F00.09 (0009H)	9	F00.09(0009H)	●
F45.11	Destination Address 4	32782	F00.14 (800EH)	32782	F00.14(800EH)	●
F45.13	Source Address 5	10	F00.10 (000AH)	10	F00.10(000AH)	●
F45.14	Destination Address 5	32783	F00.15 (800FH)	32783	F00.15(800FH)	●
F45.16	Source Address 6	8201	F00.09 (2009H)	8201	F00.09(2009H)	●
F45.17	Destination Address 6	32782	F00.14	32782	F00.14(800EH)	●

			(800EH)			
F45.19	Source Address 7	8202	F00.10 (200AH)	8202	F00.10(200AH)	●
F45.20	Destination Address 7	32783	F00.15 (800FH)	32783	F00.15(800FH)	●
F45.22	Source Address 8	2305	F09.01 (0901H)	1025	F04.01 (0401H)	●
F45.23	Destination Address 8	35073	F09.01 (8901H)	35073	F09.01(8901H)	●
F45.25	Source Address 9	10497	F09.01 (2901H)	1292	F05.12 (050CH)	●
F45.26	Destination Address 9	35073	F09.01 (8901H)	36098	F13.02(8D02H)	●
F45.28	Source Address 10	4096	C00.00 (1000H)	9217	F04.01 (2401H)	●
F45.29	Destination Address 10	4608	F18.00 (1200H)	35073	F09.01(8901H)	●
F45.31	Source Address 11	16640	4100H	9484	F05.12 (250CH)	●
F45.32	Destination Address 11	29184	7200H	36098	F13.02(8D02H)	●
F45.34	Source Address 12	4098	C00.02 (1002H)	28673	7001H(Main digital frequency)	●
F45.35	Destination Address 12	4614	F18.06 (1206H)	32775	F00.07 (8007H)	●

F45.37	Source Address 13	4100	C00.04 (1004H)	28675	7003H (Given torque)	●
F45.38	Destination Address 13	4622	F18.14 (120EH)	36098	F13.02(8D02H)	●
F45.40	Source Address 14	4097	C00.01 (1001H)	28676	7004H (PID given)	●
F45.41	Destination Address 14	4616	F18.08 (1208H)	35073	F09.01(8901H)	●
F45.43	Source Address 15	4352	E00.00 (1100H)	28680	7008H (acceleration time)	●
F45.44	Destination Address 15	4864	F19.00 (1300H)	32782	F00.14(800EH)	●
F45.46	Source Address 16	4353	E00.01 (1101H)	28681	7009H (deceleration time)	●
F45.47	Destination Address 16	4870	F19.06 (1306H)	32783	F00.15(800FH)	●
F45.49	Source Address 17	4354	E00.02 (1102H)	4096	C00.00(1000H)	●
F45.50	Destination Address 17	4876	F19.12 (130CH)	4608	F18.00(1200H)	●
F45.52	Source Address 18	7	F00.07 (0007H)	16640	4100H	●

F45.53	Destination Address 18	32775	F00.07 (8007H)	29184	7200H	●
F45.55	Source Address 19	8199	F00.07 (2007H)	4109	C00.13(100DH)	●
F45.56	Destination Address 19	32775	F00.07 (8007H)	4614	F18.06(1206H)	●
F45.58	Source Address 20	16384	4000H	4111	C00.15(100FH)	●
F45.59	Destination Address 20	28672	7000H	4616	F18.08(1208H)	●
F45.61	Source Address 21	9	F00.09 (0009H)	4097	C00.01(1001H)	●
F45.62	Destination Address 21	32782	F00.14 (800EH)	4654	F18.46(122EH)	●
F45.64	Source Address 22	10	F00.10 (000AH)	4352	E00.00(1100H)	●
F45.65	Destination Address 22	32783	F00.15 (800FH)	4864	F19.00(1300H)	●
F45.67	Source Address 23	8201	F00.09(2 009H)	4360	E00.08(1108H)	●
F45.68	Destination Address 23	32782	F00.14 (800EH)	4870	F19.06(1306H)	●
F45.70	Source Address 24	8201	F00.09 (2009H)	4368	E00.16(1110H)	●
F45.71	Destination Address 24	32782	F00.14 (800EH)	4876	F19.12(130CH)	●



After the corresponding application macro is selected by changing the function code, F12.14 will be executed automatically to restore the default settings, and the parameters will be restored the macro-specific parameters.

Function code	Function code name	Parameter description	Unit	Default setting	Attribute	Mailing address
F16.01	Set length	1 ~ 65535 (F16.13=0) 0.1 ~ 6553.5 (F16.13=1) 0.01 ~ 655.35 (F16.13=2) 0.001 ~ 65.535 (F16.13=3)	m	1,000	●	0x1001
F16.02	Pulses per meter	0.1 ~ 6553.5		100.0	●	0x1002
F16.13	Set length resolution	0:1m 1:0.1m 2:0.01 m 3:0.001m		0	○	0x1003

EM730 series inverters have a fixed-length counting function, as shown in Figure 7-40. The length counting function is performed by entering the length information from the digital input terminal in the pulse form and then setting the related function code. The final length count information can be outputted by the digital output terminal for other purposes (e.g. DI/VX input as the stop command). Users can also view the real-time length count via F18.34. The length resolution can be set by F16.13. In case of any change in the length resolution, F16.01 will change accordingly. For example, if F16.13 is set to 0:1m, the setting range of F16.01 is 1-65535m.

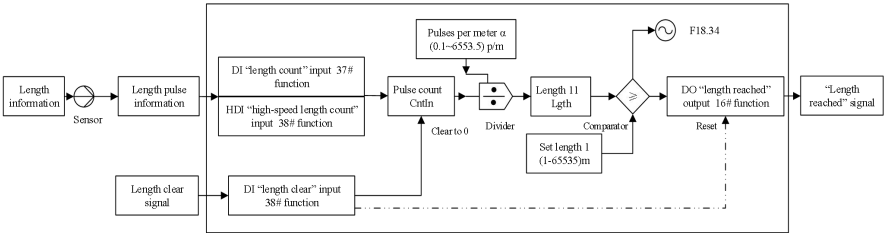

Fig. 7-40 Block Diagram of Fixed-length Counting



Principle of fixed-length counting: The length detection sensor converts the length information into pulse information. The DI terminal collects the number  $N$  of input pulses.

The length  $l_1 = \frac{N}{\alpha}$  is calculated based on the set function code “Pulses per meter”  $\alpha$  and

then compared with the “Set length”  $l$ . If  $l_1 < l$ , it means that the length does not reach the set value; otherwise, the fixed-length count is completed. The “39: Clear length” input can be applied to clear the count and reset the output signal.

When the pulse frequency is greater than 250Hz ( $=1/(2 \text{ (default filtering times)} * 2 * 1\text{ms}^{-1})$ ), make sure of the input from the high-speed pulse input terminal (X5) and set F02.06 to “38: high-speed length count input”. 250Hz is only a theoretical value. The actual effect will prevail. In order to avoid errors, use the high-speed pulse input terminal wherever possible.

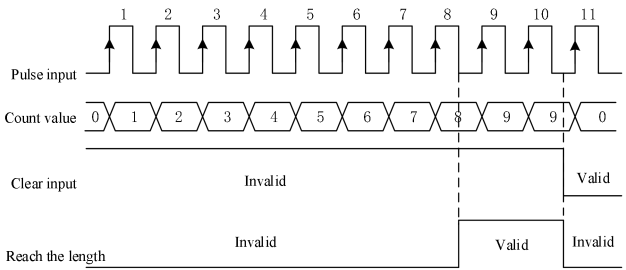

Fig. 7-15 Example of Fixed-length Counting

Fig. 7-15 shows an example, where F16.01=2 and F16.02=4.0. When the length count is 8 ( $=2 \times 4$ ), the “16: length reached” output will be valid. When the “39: clear length” input is valid, the count will be cleared, and the “16: length reached” output will be invalid.

Function code	Function code name	Parameter description	Unit	Default setting	Attribute	Mailing address
F16.03	Set count value	F16.04 ~ 65535		1,000	●	0x1003
F16.04	Specified count value	1 ~ F16.03		1,000	●	0x1004

EM730 series inverters support counting, as shown in Fig. 7-42. Pulse information is

inputted from the digital input terminal. When the count reaches the specific value, there will be the corresponding valid signal output. The user can use this signal for programming (e.g. DI/VX input as the stop command) or view the real-time count by F18.33.

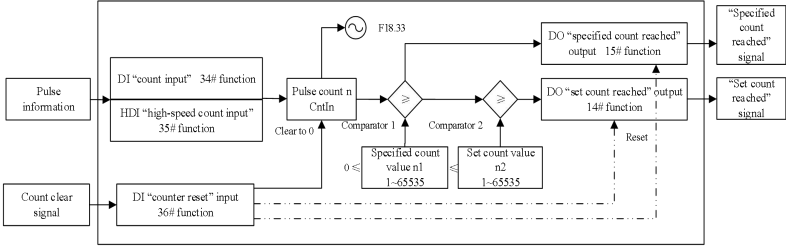

Fig. 7-42 Block Diagram of Counting Function

Counting principle: Specific information is entered in the pulse form. The number  $n$  of pulses is collected by the DI terminal and then is compared with the “specified count”  $n_1$ . If  $n < n_1$ , it means that the value does not reach the “specified count”. Otherwise, it means that the value reaches the “specified count”, the result is outputted by the DO terminal, counting is continued, and the value is compared with the “set count”  $n_2$ . If  $n < n_2$ , it means that the value does not reach the “set count”. Otherwise, it means that the value reaches the “set count”, the result will be outputted by the DO terminal and counting will be stopped. The “36: clear counter” input can be used to clear the count and reset the output signal.

When the pulse frequency exceeds 250Hz ( $=1/(2 \text{ (default filtering times)} * 2 * 1\text{ms}^{-1})$ ), make sure of the input through the high-speed pulse input terminal (X5), and set F02.06 to “35: high-speed count input”. 250Hz is only a theoretical value. The actual effect will prevail. In order to avoid errors, use the high-speed pulse input terminal wherever possible.

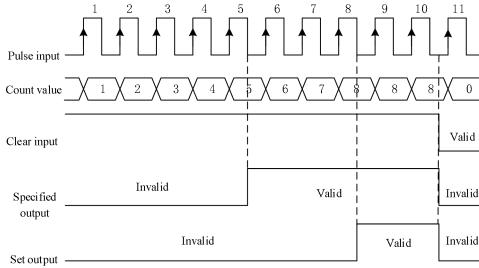



Fig. 7-16 Counting Example

Fig. 7-16 shows an example, where F16.03=8 and F16.04=5. When the count reaches the specified value 5, the output of “15: reach the specified value” will be valid. When the count reaches the set value 8, the output of “14: reach the set value” will be valid. When the input of “36: clear length” is valid, the count will be cleared to 0, and the outputs of “15: reach the specified value” and “14: reach the set value” will be invalid.

 Limit65535 ≥ set count ≥ specified count ≥ 0. If the set count and specified count are 0, the counter function will be invalid. This function is allowed for one terminal only at a time.

Function code	Function code name	Parameter description	Unit	Default setting	Attribute	Mailing address
F16.05	Set time of regular running	0.0~6500.0, 0.0 is invalid	min	0.0	●	0x1005

Regular running function: The regular running function can be enabled by setting this function code other than 0. When the running time reaches the set time, the inverter will be shut down, and the terminal output of the option “26: reach the set time” will be valid, and there will be a prompt indicating that the inverter has been run for the set time.

Users can view the remaining time of regular running by F18.35, or clear the current running time by the input function “27: clear regular running time” (i.e. resetting F18.35). This represents the set time in the non-running status and remaining time in the running status. That is, one regular running process lasts from start to stop, and the accumulated time in the non-running status will be cleared.

Function code	Function code name	Parameter description	Unit	Default setting	Attribute	Mailing address
F16.06	Agent password	0 ~ 65535		0	○	0x1006

Agent password.

- ★ After this password is set, the inverter may fail to work normally. Be careful to set this password.

Function code	Function code name	Parameter description	Unit	Default setting	Attribute	Mailing address
F16.07	Setting of cumulative power-on arrival time	0~65535; 0: disable the protection when the power-on time is up	h	0	○	0x1007

Set the total cumulative power-on time. If the cumulative power-on time (F12.15) reaches or exceeds the total cumulative power-on time (F16.07), please contact the agent for maintenance.

- ★ After this parameter is set, the inverter may fail to work normally. Be careful to set this parameter.

Function code	Function code name	Parameter description	Unit	Default setting	Attribute	Mailing address
F16.08	Setting of cumulative running arrival time	0~65535; 0: disable the protection when the running time is up	h	0	○	0x1008

Set the total cumulative running time. If the cumulative running time (F12.17) reaches or exceeds the total cumulative running time (F16.08), please contact the agent for maintenance.

- ★ After this parameter is set, the inverter may fail to work normally. Be careful to set this parameter.

Function code	Function code name	Parameter description	Unit	Default setting	Attribute	Mailing address
F16.09	Factory password	0~ 65535		XXXXX	●	0x1009

Factory password.

- ★ After this password is set, the inverter may fail to work normally. Be careful to set this password.

Function code	Function code name	Parameter description	Unit	Default setting	Attribute	Mailing address
F16.10	Analog output percentage corresponding to	0.00~100.00	%	0.00	○	0x100A

	the count value 0					
F16.11	Analog output percentage corresponding to the set count value	0.00~100.00	%	100.00	○	0x100B

The analog output is set as the offset of count and length output.

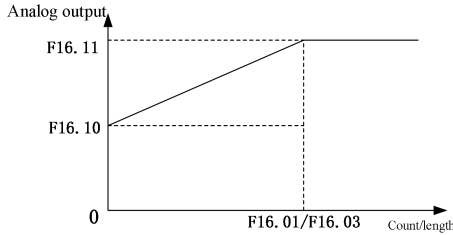

Fig. 7-17 Schematic Diagram of Analog Output of Count and Length

### 7.18 Virtual I/O Function Parameter Group of F17 Group

The standard EM730 series inverter is equipped with eight virtual multi-function input terminals (VX1 to VX8), of which the functions and usages are basically the same as those of the actual input terminals. Differences are described below. For their similarities, refer to the parameter description of Function Parameter Group of Input Terminal of F02 Group.

Function code	Function code name	Parameter description	Unit	Default setting	Attribute	Mailing address
F17.00	VX1 virtual input function options	The same as the digital input terminal function options of the F02 group. See the function list of the digital multi-function input terminal in Table 7-2.		0	○	0x1100
F17.01	VX2 virtual input function options			0	○	0x1101
F17.02	VX3 virtual input function options			0	○	0x1102
F17.03	VX4 virtual input function options			0	○	0x1103
F17.04	VX5 virtual input function options			0	○	0x1104
F17.05	VX6 virtual input function options			0	○	0x1105
F17.06	VX7 virtual input function options			0	○	0x1106
F17.07	VX8 virtual input function options			0	○	0x1107
F17.08	Virtual input		D7   D6   D5   D4   D3   D2   D1   D0		000	○

	positive/negative logic	VX 7	VX 6	VX 6	VX 5	VX 4	VX 3	VX 2	VX 1		00000		
		0: positive logic, valid in the closed state/invalid in the open state 1: negative logic, invalid in the closed state/valid in the open state											
F17.11	VX1 valid delay time	0.000~30.000								s	0.000	●	0x110B
F17.12	VX1 invalid delay time	0.000~30.000								s	0.000	●	0x110C
F17.13	VX2 valid delay time	0.000~30.000								s	0.000	●	0x110D
F17.14	VX2 invalid delay time	0.000~30.000								s	0.000	●	0x110E
F17.15	VX3 valid delay time	0.000~30.000								s	0.000	●	0x110F
F17.16	VX3 invalid delay time	0.000~30.000								s	0.000	●	0x1110
F17.17	VX4 valid delay time	0.000~30.000								s	0.000	●	0x1111
F17.18	VX4 invalid delay time	0.000~30.000								s	0.000	●	0x1112

The terminals VX1 to VX8 essentially have the same function, but there are no corresponding physical terminals actually. They all have the positive and negative logic functions. The terminals VX1 to VX4 have the delay function, and their statuses can be confirmed in the same way. They can be set separately. The terminal VX1 is taken as an example below.

Function code	Function code name	Parameter description								Unit	Default setting	Attribute	Mailing address
F17.09	VX1~VX8 status setting options	D7	D6	D5	D4	D3	D2	D1	D0		000 00000	○	0x1109
		VX8	VX7	VX6	VX5	VX4	VX3	VX2	VX1				
		0: the VXn status is the same as VYn output status 1: status set by F17.10											
F17.10	VX1~VX8 status setting	D7	D6	D5	D4	D3	D2	D1	D0		000 00000	●	0x110A
		VX8	VX7	VX6	VX5	VX4	VX3	VX2	VX1				
		0: invalid 1: valid											

- When F17.09=xxxxxxx0, the VX1 status is the same as the VY1 output status.

As stated literally, the status of the virtual input terminal is the same as that of the virtual output terminal, so this should be used in conjunction with the virtual output terminal.

If F17.19=16 (reach the length) and F17.28=xxxx xxx1 (the VY1 status depends on the output function status) under the default conditions, and “16: reach the length” is valid, the VY1 output and VX1 synchronization will be valid. The corresponding operations (length count clearing and VY1 output status resetting) can be performed according to the VX1 setting (assuming “39: length clearing”). Then the fixed length count function can be enabled again to meet the requirements for repeated processing. If there are certain intervals between repeated processing procedures, you can also complete the aforesaid operations by setting the VX1 delay.

- When F17.09=xxxxxxx1, the VX1 status depends on the bit 0 of the function code F17.10.

The status of the virtual input terminal is directly dependent on the function code. This is mainly used for remote control by the host. The remote control terminal can be used to enable and disable the input terminal status directly with the function code 0x41 by changing the value of F17.10 through communication.

The standard EM730/EM730E series inverter is equipped with eight virtual multi-function output terminals (VY1 to VY8), and their functions and usages are essentially the same as those of the actual output terminals. Differences are described below. For their similarities, refer to the parameter description of Function Parameter Group of Output Terminal of F03 Group.

Function code	Function code name	Parameter description	Unit	Default setting	Attribute	Mailing address
F17.19	VY1 virtual output function options	The same as the digital output terminal function options of the F03 group, as detailed in Table 7-8 Function List of Multi-function Digital Output Terminals		0	○	0x1113
F17.20	VY2 virtual output function options			0	○	0x1114
F17.21	VY3 virtual output function options			0	○	0x1115
F17.22	VY4 virtual output function options			0	○	0x1116
F17.23	VY5 virtual output function options			0	○	0x1117
F17.24	VY6 virtual output			0	○	0x1118

	function options												
F17.25	VY7 virtual output function options										0	○	0x1119
F17.26	VY8 virtual output function options										0	○	0x111A
F17.27	Virtual output positive/negative logic	D7	D6	D5	D4	D3	D2	D1	D0	0: positive logic, valid in the closed state/invalid in the open state 1: negative logic, invalid in the closed state/valid in the open state	000 00000	○	0x111B
		VY8	VY7	VY6	VY5	VY4	VY3	VY2	VY1				
F17.29	VY1 valid delay time	0.000~30.000								s	0.000	●	0x111D
F17.30	VY1 invalid delay time	0.000~30.000								s	0.000	●	0x111E
F17.31	VY2 valid delay time	0.000~30.000								s	0.000	●	0x111F
F17.32	VY2 invalid delay time	0.000~30.000								s	0.000	●	0x1120
F17.33	VY3 valid delay time	0.000~30.000								s	0.000	●	0x1121
F17.34	VY3 invalid delay time	0.000~30.000								s	0.000	●	0x1122
F17.35	VY4 valid delay time	0.000~30.000								s	0.000	●	0x1123
F17.36	VY4 invalid delay time	0.000~30.000								s	0.000	●	0x1124

The terminals VY1 to VY8 essentially have the same function, but there are no corresponding physical terminals actually. They all have the positive and negative logic functions. The terminals VY1 to VY4 have the delay function, and their statuses can be confirmed in the same way. They can be set separately. The terminal VY1 is taken as an example below.

Function code	Function code name	Parameter description								Unit	Default setting	Attribute	Mailing address
F17.28	Control options of virtual output terminal	D7	D6	D5	D4	D3	D2	D1	D0	0: depending on the status of terminal X1-X5 (without VY6-8) 1: depending on the output function status	111 11111	○	0x111C
		VY8	VY7	VY6	VY5	VY4	VY3	VY2	VY1				

● F17.28=xxxxxxx0: the VY1 status is the same as the actual input status of X1.



The status of the virtual output terminal VY1 is synchronized with that of the actual input terminal X1. This can be applied in programming of multiple functions such as status confirmation or enabling of one switch.

- F17.28=xxxxxxx1: the VY1 status depends on the selected function status of the function code F17.19.

The status of the virtual output terminal depends on the set function status, and its main output is for software programming. The PID can be controlled via “reaching the upper limit of PID feedback” as follows: outputting the signal “19: reach the upper limit of PID feedback” through the virtual output terminal VY1 (F17.19=19), collecting it through the virtual input terminal VX1 and then setting the VX1 function to “41: process PID pause” (F17.00=41).

Note: The D7 bit of the VY8 option must be set to 1. That is, the VY8 function is always dependent on the output function status.

Function code	Function code name	Parameter description								Unit	Default setting	Attribute	Mailing address
F17.37	Virtual input terminal status	VX8	VX7	VX6	VX5	VX4	VX3	VX2	VX1		000 00000	×	0x1125
		0: invalid 1: valid											
F17.38	Virtual output terminal status	VY8	VY7	VY6	VY5	VY4	VY3	VY2	VY1		000 00000	×	0x1126
		0: invalid 1: valid											

The real-time status of the current virtual terminal is displayed.

### 7.19 Monitoring Parameter Group of F18 Group

This group of parameters is used only to view the current status of the inverter and cannot be changed.

Function code	Function code name	Parameter description	Unit	Mailing address
F18.00	Output frequency	Display the current output frequency of the inverter. Scope: 0.00 to upper frequency limit. ★: This parameter will be updated promptly in the speed control mode.	Hz	0x1200
F18.01	Set frequency	Display the current set frequency of the inverter. Scope: 0.00 to maximum frequency F00.16. ★: This parameter will be updated promptly in the speed control mode.	Hz	0x1201

F18.02	Reserved			0x1202
F18.03	Estimate feedback frequency	Display the estimated feedback frequency in the SVC control mode. Scope: 0.00 to upper frequency limit. ★: This parameter will be updated promptly in the SVC control mode.	Hz	0x1203
F18.04	Output torque	Display the current output torque of the inverter. Scope: -200.0 ~ 200.0.	%	0x1204
F18.05	Torque setting	Display the current set torque of the inverter. Scope: -200.0 ~ 200.0. ★: This parameter will be updated promptly in the torque control mode.	%	0x1205
F18.06	Output current	Display the current output current of the inverter. Depending on the rated power level of the motor, the range is as follows: 0.00 to 650.00 (rated power of motor: ≤ 75 kW) 0.0 to 6500.0 (rated power of motor: > 75 kW)	A	0x1206
F18.07	Output current percentage	Display the current output current as a percentage (relative to the rated current of the inverter). Range: 0.0 to 300.0.	%	0x1207
F18.08	Output voltage	Display the current output voltage of the inverter. Scope: 0.0 ~ 690.0.	V	0x1208
F18.09	DC bus voltage	Display the current bus voltage. Scope: 0 - 1200.	V	0x1209
F18.10	Simple PLC running times	When the auxiliary frequency source B is involved in setting (F00.06 ≠ 0), the setting mode is “11: simple PLC” (F00.05=11) and the simple PLC runs in the mode of limited cycles (F08.15=1/2), the real-time number of cycles will be displayed. “0” indicates that the first operation is being performed, and “1” indicates that the first operation has been completed and the second operation is being carried out. Scope: 0 - F08.16.		0x120A
F18.11	Simple PLC operation stage	When the auxiliary frequency source B is involved in setting (F00.06 ≠ 0), and the setting mode is “11: simple PLC” (F00.05=11), the real-time PLC running status will be displayed. Scope: 1-15, corresponding to the multi-segment speed 1 (F08.00) to multi-segment speed 15 (F08.14).		0x120B
F18.12	PLC running time at the current stage	When the auxiliary frequency source B is involved in setting (F00.06 ≠ 0) and the setting mode is “11: simple PLC” (F00.05=11), the PLC running time at the current stage will be displayed in a real-time manner. Scope: 0.0 to the set time of the corresponding segment (example: the time of the first segment is dependent on F08.20).	s / min	0x120C
F18.13	Reserved			0x120D

F18.14	Load rate	Display the current load speed. For the correct display, please set the load speed display factor (F12.09). Scope: 0 ~ 65535.	rpm	0x120E										
F18.15	UP/DOWN offset frequency	Display the UP/DOWN offset frequency. See the UP/DOWN function description of F12.10 to F12.12.	HHz	0x120F										
F18.16	PID setting	Display the current PID setting, except for the current setting percentage (F09.03).		0x1210										
F18.17	PID feedback	Display the current PID feedback, except for the current feedback percentage (F09.03).		0x1211										
F18.18	Power meter: MWh	Display the cumulative input (output + fan) power consumption in MWh (thousand KWh). The current power consumption can be obtained in conjunction with F18.19.	MWh	0x1212										
F18.19	Watt-hour meter: kWh	Display the cumulative input (output + fan) power consumption in kWh (kilowatt-hour). The current power consumption can be obtained in conjunction with F18.18.	kWh	0x1213										
F18.20	Output power	Display the current output power of the inverter. Scope: -650.00~650.00.	kW	0x1214										
F18.21	Output power factor	Display the current output power factor of the inverter. Scope: -1.00 ~ 1.00.		0x1215										
F18.22	Digital input terminal status 1	<p>Display the current valid status of the input terminals X1 to X5. The five-bit digit tubes from left to right are:</p> <table border="1" style="margin-left: 20px;"> <tr> <td>X5</td> <td>X4</td> <td>X3</td> <td>X2</td> <td>X1</td> </tr> <tr> <td>0/1</td> <td>0/1</td> <td>0/1</td> <td>0/1</td> <td>0/1</td> </tr> </table> <p>The actual display effect is: 00000.                      ★ : “0” means that the current terminal function is invalid; and “1” means that the current terminal function is valid.</p>	X5	X4	X3	X2	X1	0/1	0/1	0/1	0/1	0/1		0x1216
X5	X4	X3	X2	X1										
0/1	0/1	0/1	0/1	0/1										
F18.23	Digital input terminal status 2	<p>Display the current valid status of the input terminals AI1 and AI2. The five-bit digit tubes from left to right are:</p> <table border="1" style="margin-left: 20px;"> <tr> <td>*</td> <td>AI2</td> <td>AI1</td> <td>*</td> <td>*</td> </tr> <tr> <td>0/1</td> <td>0/1</td> <td>0/1</td> <td>0/1</td> <td>0/1</td> </tr> </table> <p>The actual display effect is: 0000.                      ★ : The analog input terminals AI1 and AI2 of the EM730 series inverter can be used for digital input only.                      “0” means that the current terminal function is invalid; and “1” means that the current terminal function is valid.</p>	*	AI2	AI1	*	*	0/1	0/1	0/1	0/1	0/1		0x1217
*	AI2	AI1	*	*										
0/1	0/1	0/1	0/1	0/1										
F18.25	Output terminal state	<p>Display the current valid status of the output terminals R1/Y1. The five-bit digital tubes from left to right are:</p> <table border="1" style="margin-left: 20px;"> <tr> <td>*</td> <td>*</td> <td>R1</td> <td>*</td> <td>Y1</td> </tr> <tr> <td>0/1</td> <td>0/1</td> <td>0/1</td> <td>0/1</td> <td>0/1</td> </tr> </table> <p>The actual display effect is: 000.                      “0” means that the current function terminal is invalid;</p>	*	*	R1	*	Y1	0/1	0/1	0/1	0/1	0/1		0x1219
*	*	R1	*	Y1										
0/1	0/1	0/1	0/1	0/1										

		and “1” means that the current function terminal is valid.		
F18.26	AI1	Display the per-unit value of the current analog input channel 1 (AI1) relative to 100.0%. Scope: -100.0~100.0	%	0x121A
F18.27	AI2	Display the per-unit value of the current analog input channel 2 (AI2) relative to 100.0%. Scope: 0.0 ~100.0.	%	0x121B
F18.30	Reserved			0x121E
F18.31	High-frequency pulse input frequency: kHz	0.00~100.00	kHz	0x121F
F18.32	High-frequency pulse input frequency: Hz	0~65535	Hz	0x1220
F18.33	Count value	0~65535		0x1221
F18.34	Actual length	0~65535	m	0x1222
F18.35	Remaining time of regular running	Display the remaining time of regular running. For specific function, see the description of the F16.05 regular running function. Scope: 0.0~F16.05.	min	0x1223
F18.36	Rotor position of synchronous motor	0.0~359.9°		0x1224
F18.37 ~ F18.38	Reserved			0x1225 ~ 0x1226
F18.39	VF separation target voltage	Display the VF separation target voltage in a real-time manner. Scope: 0.0 to rated voltage of the motor	V	0x1227
F18.40	VF separation output voltage	Display the actual output voltage of VF separation in a real-time manner. Scope: 0.0 to rated voltage of the motor	V	0x1228
F18.41 ~ F18.44	Reserved			0x1229 ~ 0x122C
F18.45	Speed setting	0~65535	rmp	0x122D
F18.46	Output frequency symbol	0~65535		0x122E
F18.47 ~ F18.50	Reserved			0x122F ~ 0x1232
F18.51	PID output	-100.0~100.0	%	0x1233
F18.60	Inverter temperature	-40 ~ 200	°C	0x123C
F18.67	Cumulative energy saving	0~65535	MWh	0x1243

	MWH			
F18.68	Cumulative energy saving KWH	0.0 ~ 999.9	kWh	0x1244
F18.69	High cumulative cost saving (*1000)	0 ~ 65535		0x1245
F18.70	Low cumulative cost saving	0.0 ~ 999.9		0x1246
F18.71	Power-frequency power consumption MWH	0~ 65535	MWh	0x1247
F18.72	Power-frequency power consumption KWH	0.0~999.9	kWh	0x1248

## 7.20 F19 protection record parameter group

These parameters are used only to view the types of recent three protections of the inverter and the inverter status in protection. They cannot be changed.

- The function codes related to the last protection are as follows:

Function code	Function code name	Parameter description	Unit	Default setting	Attribute	Mailing address
F19.00	Category of last protection	Display the type of the last protection, as detailed in Table 7-24 List of Protection Types.		0	×	0x1300
F19.01	Output frequency in protection	Display the output frequency of the last protection.	Hz	0.00	×	0x1301
F19.02	Output current in protection	Display the output current of the last protection.	A	0.00/0.0	×	0x1302
F19.03	Bus voltage in protection	Display the bus voltage of the last protection.	V	0	×	0x1303
F19.04	Operating status in protection	Display the running status of the last protection, as detailed in Table 7-25 List of Running Statuses during Protection.		0	×	0x1304
F19.05	Working time in protection	Display the working time of the last protection.	h	0	×	0x1305

- The function codes related to the previous protection are as follows:

Function code	Function code name	Parameter description	Unit	Default setting	Attribute	Mailing address
F19.06	Category of previous protection	Display the type of the previous protection, as detailed in Table 7-24 List of Protection Types.		0	×	0x1306
F19.07	Output frequency in protection	Display the output frequency of the previous protection.	Hz	0.00	×	0x1307
F19.08	Output current in protection	Display the output current of the previous protection.	A	0.00/0.0	×	0x1308
F19.09	Bus voltage in protection	Display the bus voltage of the previous protection.	V	0	×	0x1309
F19.10	Operating status in protection	Display the running status of the previous protection, as detailed in Table 7-25 List of Running Statuses during Protection.		0	×	0x130A
F19.11	Working time in protection	Display the working time of the previous protection.	h	0	×	0x130B

- The function codes related to the previous two protections are as follows:

Function code	Function code name	Parameter description	Unit	Default setting	Attribute	Mailing address
F19.12	Category of two previous protections	Display the type of the previous two protections, as detailed in Table 7-24 List of Protection Types.		0	×	0x130C
F19.13	Output frequency in protection	Display the output frequency of the previous two protections.	Hz	0.00	×	0x130D
F19.14	Output current in protection	Display the output current of the previous two protections.	A	0.00 /0.0	×	0x130E
F19.15	Bus voltage in protection	Display the bus voltage of the previous two protections.	V	0	×	0x130F
F19.16	Operating status in protection	Display the running status of the previous two protections, as detailed in Table 7-25 List of Running Statuses during Protection.		0	×	0x1310
F19.17	Working time in protection	Display the working time of the previous two protections.	h	0	×	0x1311

Different types of protection of EM730 series inverters are explained in Table 7-24.

Table 7-24 List of Protection Types

Protection Type	Keyboard display	Protection Type	Keyboard display
0: no protection	0	E01: output short circuit protection	E01
E02: instantaneous overcurrent	E02	E03: reserved	E03
E04: steady-state overcurrent	E04	E05: steady-state overvoltage	E05
E06: steady-state undervoltage	E06	E07: input phase loss	E07
E08: output phase loss	E08	E09: inverter overload	E09
E10: inverter overheat protection	E10	E11: parameter setting conflict	E11
E12: reserved	E12	E13: motor overload	E13
E14: external protection	E14	E15: inverter memory protection	E15
E16: communication abnormality	E16	E17: temperature sensor abnormality	E17
E18: disengaged soft start relay	E18	E19: current detection circuit abnormality	E19
E20: stall protection	E20	E21: PID feedback disconnection	E21
E20: reserved	E22	E23: keyboard memory protection	E23
E24: parameter identification abnormality	E24	E25: reserved	E25
E26: off-load protection	E26	E27: up to the cumulative power-on time	E27
E28: up to the cumulative running time	E28	E29: internal communication protection	E29
E44: cable protection	E44	E43: material cutoff protection	E43
E57: overpressure in pipeline network	E57	E58: under-pressure in pipeline network	E58
E68: SVC start failure (synchronous motor)	E68	E76: short circuit to ground	E76

The running status of EM730 series inverters during protection is explained in Table 7-25:

Table 7-25 List of Running Statuses during Protection

Keyboard display	Detailed Explanation of Running Status of Inverter
0	Not running
1	Forward acceleration
2	Reverse acceleration
3	Forward deceleration
4	Reverse deceleration
5	Forward constant speed
6	Reverse constant speed

### 7.21 F27 winding and unwinding application macro parameter group

Function code	Function code name	Parameter description	Unit	Default setting	Attribute	Mailing address
F27.00	Application macro	0: winding mode 1: unwinding mode 2: wire drawing mode 3: straight wire drawing machine mode		0	○	0x1B00

**F27.00=0 Winding mode:**

This mode can be used for winding. After the default settings are restored, the parameters will be restored for winding applications.

**F27.00=1 Unwinding mode:**

This mode can be used for unwinding. After the default settings are restored, the parameters will be restored for unwinding applications.

**F27.00=2 Wire drawing mode:**

This mode can be used for wire drawing. After the default settings are restored, the parameters will be restored for wire drawing applications.

**F27.00=3 Straight wire drawing machine mode:**

This mode can be used for the straight wire drawing machine. After the default settings are restored, the parameters will be restored for the straight wire drawing machine.

Function	Note	0: Winding	1: Unwinding	2: Wire	3: Straight wire



code		mode	mode	drawing mode	drawing machine mode
Set F16.00=3, select the operation mode and restore the default settings. The application parameters are automatically set to the following default values.					
<b>Basic parameters</b> (the motor parameters need to be set manually and subject to static self-learning)					
F00.02	Command source	1: Terminal control	1: Terminal control	1: Terminal control	1: Terminal control
F00.03	Terminal control mode	0: terminal RUN	0: terminal RUN	0: terminal RUN	0: terminal RUN
F00.04	Main frequency A	1: AI1 setting	0: Digital setting	1: AI1	1: AI1 setting
F00.05	Auxiliary frequency B	10: process PID	10: process PID		10: process PID
F00.06	Frequency source	6: Auxiliary frequency B + feedforward calculation	6: Auxiliary frequency B + feedforward calculation		6: Auxiliary frequency B + feedforward calculation
F00.07	Main frequency A setting		75.00Hz		
F00.14	Acceleration time	1.00s	1.00s	70.00s	1.00s
F00.15	Deceleration time	1.00s	1.00s	70.00s	1.00s

F00.16	Maximum frequency	75.00Hz	75.00Hz	75.00Hz	50.00Hz
F00.18	Upper frequency limit	75.00Hz	75.00Hz	75.00Hz	50.00Hz
F00.20	Reverse control	1: Prohibit reversing	0: Allow forward/reverse running	1: Prohibit reversing	0: Allow forward/reverse running
F02.00	X1 terminal	1: RUN	1: RUN	1: RUN	1: RUN
F02.01	X2 terminal	89: Reset feedforward	89: Reset feedforward	19: acceleration and deceleration time terminal 1	2: FR reverse
F02.02	X3 terminal	121: External material cutoff signal	121: External material cutoff signal	10: Reset protection	10: Reset protection
F02.03	X4 terminal	10: Reset protection	10: Reset protection	4: FJOG	26: Frequency source switching
F02.04	X5 terminal	9: free stop	9: free stop	9: free stop	121: External material cutoff signal
F02.57	AI1 filtering	0.05s	0.05s	0.05s	0.05s
F02.58	AI2 filtering	0.00s	0.00s	0.00s	0.00s
F03.00	Y1 Output	3:FDT1	3:FDT1	3:FDT1	68: Material cutoff detection

F03.02	R1 output	7: Inverter protection	7: Inverter protection	7: Inverter protection	7: Inverter protection
F03.08	Jog output control			0b01100: FDT jog without output	
F04.19	Stop mode	1: free stop	1: free stop	0: slow down to stop	1: free stop
F04.20	Starting frequency of DC braking in stop			2.50Hz	
F04.22	DC braking time in stop	3.00s	3.00s	3.00s	
F04.23	Demagnetization time for DC braking in stop	0.00s	0.00s	0.00s	
F05.11	Slip compensation gain	0.00%	0.00%	0.00%	
F05.00	VF curve selection				1
F05.02	VF voltage point V1				3.0%
F05.04	VF voltage				6.0%

	point V2				
F05.06	VF voltage point V3				15.0%
F07.11	Current limit				0: Invalid
F15.01	Jog acceleration time			8.00s	
F15.02	Jog deceleration time			8.00s	
F15.03	Acceleration time 2			70.00s	
F15.04	Deceleration time 2			5.00s	
F15.21	FDT1 setting	1.00Hz	1.00Hz	2.00Hz	1.00Hz
F15.22	FDT1 hysteresis	-1.50Hz	-1.50Hz	-1.00Hz	-1.50Hz
F15.23	FDT2	1.00Hz	1.00Hz	2.00Hz	1.00Hz
F15.24	FDT2 hysteresis	-1.50Hz	-1.50Hz	-1.00Hz	-1.50Hz
F15.30	Energy consumption braking	1: valid	1: valid	1: valid	1: valid
<b>PID parameters</b>					
F09.01	PID setting	5.0	5.0		5.0

F09.02	Feedback channel	2: AI2	2: AI2		2: AI2
F09.03	PID range	10.0	10.0		10.0
F09.05	Proportion 1	0.06	0.30		0.03
F09.06	Integral 1	0.000s	0.000s		4.000s
F09.07	Differential 1	30.000ms	30.000ms		30.000ms
F09.08	Proportion 2	0.10	0.40		0.07
F09.09	Integral 2	0.000s	0.000s		4.000s
F09.10	Differential 2	30.000ms	30.000ms		50.000ms
F09.11	Parameter switching mode	2: automatic switching according to deviation	3: Automatic switching by frequency		2: automatic switching according to deviation
F09.12	Deviation 1	5.00%	0.00%		5.00%
F09.13	Deviation 2	45.00%	100.00%		45.00%
F09.16	Upper limit of PID output				40.0%
F09.17	Lower limit of PID output	-50.0%	-50.0%		-40.0%
F09.19	Differential limit	1.00%	1.00%		0.50%
F09.21	PID setting change time	2.000s	2.000s		0.500s
F09.35	Upper limit	9.50V	9.50V		9.50V

	of feedback voltage				
F09.36	Lower limit of feedback voltage	0.50V	0.50V		0.50V
F09.37	Options of integral action of PID change setting				2: Start when the error is less than F09.38

**Feedforward parameters and other settings**

F27.01	Feedforward channel	1:Feed-forward * main A	2: Feedforward *10V		1: Feedforward * main A
F27.02	Feedforward range	1:0.00 to upper limit	2: -upper limit to upper limit		0: No change in feedforward gain
F27.04	Upper limit of feedforward	500.00%	100.00%		500.00%
F27.05	Initial feedforward	50.00%	0.00%		100.00%
F27.13	Soft start increment	0.60%/s	0.70%/s		
F27.14	Feedforward increment 1	0.11%/s	0.18%/s		
F27.15	Feedforward increment 2	0.30%/s	0.50%/s		

F27.16	Feedforward increment 3	0.75%/s	1.30%/s		
F27.17	Feedforward increment 4	1.55%/s	2.75%/s		
F27.18	Feedforward increment 5	4.00%/s	7.40%/s		
F27.19	Feedforward increment 6	11.00%/s	20.50%/s		
F27.20	Material cutoff control	1201	101	1201	201

**Wiring diagram of double-frequency wire drawing machine:**

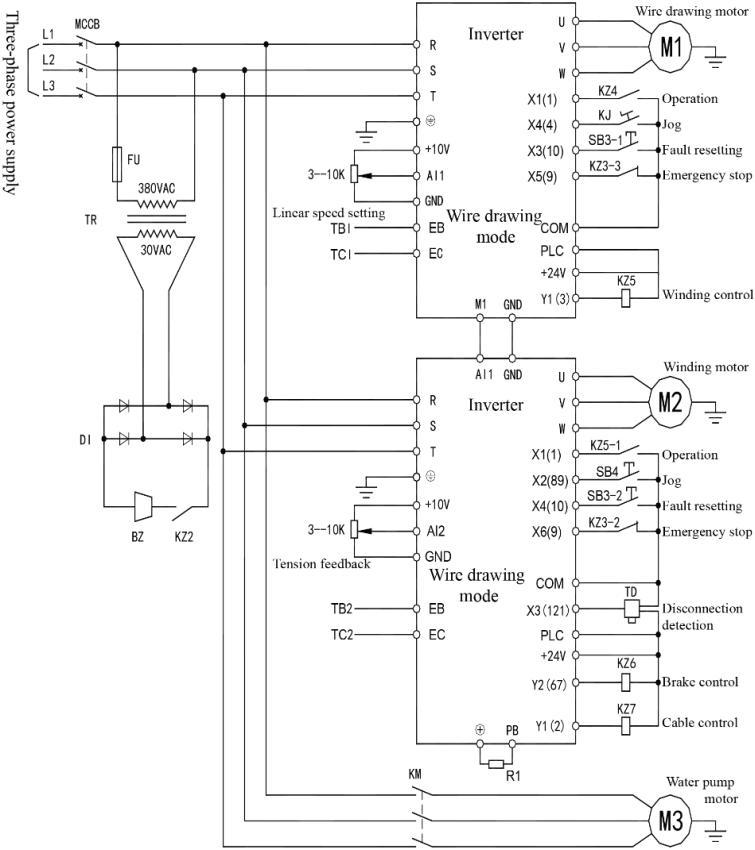

**Note:**

1. The output terminal function is not set to 67 by default (brake control function). For brake control of the inverter, set the related terminal function, and check whether F27.25 to F27.26 are appropriate.
2. The unwinding function is similar to the straight wire drawing machine. Refer to the wiring diagram of winding and list of parameter macros for wiring.

**Electrical connection diagram:**



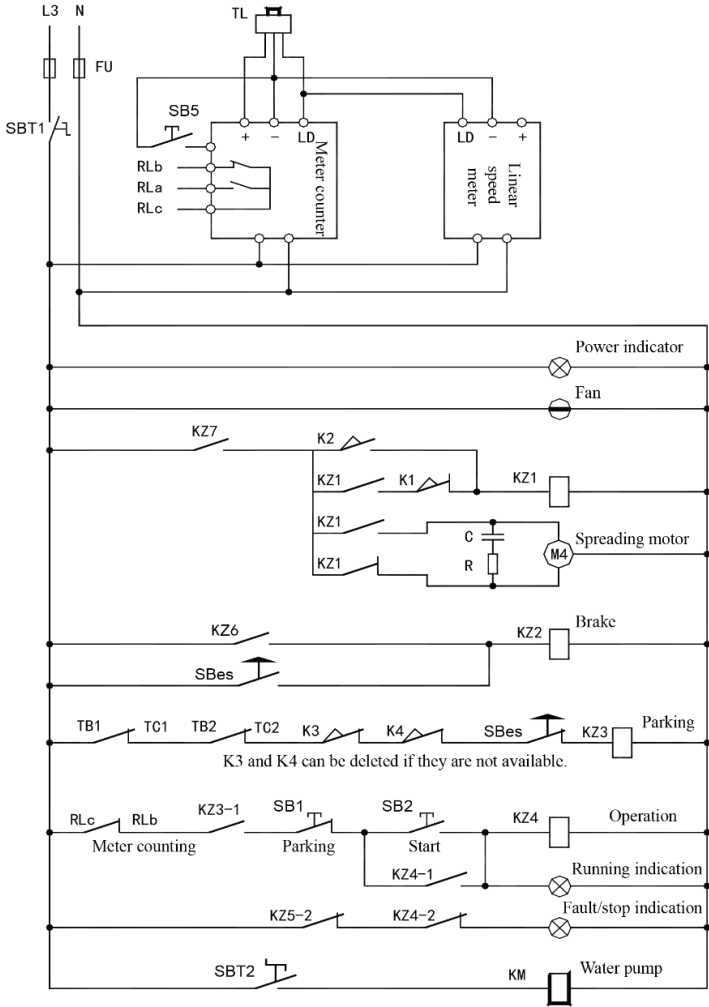

Function code	Function code name	Parameter description	Unit	Default setting	Attribute	Mailing address
F27.01	Feedforward gain action channel	0: feedforward gain * set source B 1: feedforward gain * set source A 2: feedforward gain * 10V		1	○	0x1B01

**F27.01=0 Feedforward gain \* set source B:**

The feedforward gain acts on the set source B.

**F27.01=1 Feedforward gain \* set source A A:**

The feedforward gain acts on the set source A.

**F27.01=2 Feedforward gain \*10V:**

The feedforward gain is directly multiplied by Fmax and then superimposed on the output.

Function code	Function code name	Parameter description	Unit	Default setting	Attribute	Mailing address
F27.02	Feedforward gain input mode	0: no change in feedforward gain 1: 0.00 to upper limit of feedforward gain 2: - upper limit of feedforward gain to + upper limit of feedforward gain		1	○	0x1B02

**F27.02=0 Unchanged feedforward gain:**

The feedforward gain is always the set value of F27.05.

**F27.02=1 0.00 to upper limit of feedforward gain:**

The feedforward gain will be automatically adjusted between 0.00 and F27.04 settings.

**F27.02=2 - Upper limit of feedforward gain to + upper limit of feedforward gain:**

The feedforward gain will be automatically adjusted between -F27.04 and + F27.04 settings.



The unmarked settings are the same as those of F27.00=0 by default.

Function code	Function code name	Parameter description	Unit	Default setting	Attribute	Mailing address
F27.03	Feedforward control	Ones place: feedforward reset option 0: automatic resetting 1: terminal resetting Tens place: feedforward power-off stop option 0: save after power-off 1: do not save after power-off Hundreds place: continuous feedforward calculation 0: not calculate		10	○	0x1B03

		1: continuous calculation				
--	--	---------------------------	--	--	--	--

**Set the ones place of F27.03 to 0: automatic reset**

Automatic reset: The feedforward gain is reset automatically after shutdown.

**Set the ones place of F27.03 to 1: terminal reset**

Terminal reset: The feedforward gain is reset by the terminal.

**Set the tens place of F27.03 to 0: save after power failure**

Save after power failure: When the feedforward gain is powered off and then powered on, the value before power failure will be restored.

**Set the tens place of F27.03 to 1: not save after power failure**

Not save after power failure: When the feedforward gain is powered off and then powered on, the initial feedforward gain will be restored.

**Set the hundreds place of F27.03 to 0: not calculate (only for the straight wire drawing machine)**

No calculation: When the DI input function “26: frequency source switching” of the external terminal is enabled, the feedforward calculation will not be continued.

**Set the hundreds place of F27.03 to 1: calculate (only for the straight wire drawing machine)**

No calculation: When the DI input function “26: frequency source switching” of the external terminal is enabled, the feedforward calculation will be continued.

Function code	Function code name	Parameter description	Unit	Default setting	Attribute	Mailing address
F27.04	Upper limit of feedforward gain	0.00~500.00	%	500.00	○	0x1B04

Upper limit of feedforward gain setting or change

Function code	Function code name	Parameter description	Unit	Default setting	Attribute	Mailing address
F27.05	Initial feedforward gain	0.00~500.00	%	50.00	●	0x1B05

Initial value of feedforward gain

User Manual of EM730 Series Inverter

Function code	Function code name	Parameter description	Unit	Default setting	Attribute	Mailing address
F27.06	Feedforward gain filter time	0~1000	ms	0	●	0x1B06

Under normal circumstances, it is not necessary to set the filtering of feedforward gain.

Function code	Function code name	Parameter description	Unit	Default setting	Attribute	Mailing address
F27.07	Feedforward range 0	0.00 to feedforward range 1	%	4.00	●	0x1B07
F27.08	Feedforward range 1	Feedforward range 0 to feedforward range 2	%	12.00	●	0x1B08
F27.09	Feedforward range 2	Feedforward range 1 to feedforward range 3	%	23.00	●	0x1B09
F27.10	Feedforward range 3	Feedforward range 2 to feedforward range 4	%	37.00	●	0x1B0A
F27.11	Feedforward range 4	Feedforward range 3 to feedforward range 5	%	52.00	●	0x1B0B
F27.12	Feedforward range 5	Feedforward range 4 to 100.00	%	72.00	●	0x1B0C
F27.13	Soft start increment	0.00 ~ 50.00	%/s	0.60	●	0x1B0D
F27.14	Feedforward increment 1	0.00 ~ 50.00	%/s	0.11	●	0x1B0E
F27.15	Feedforward increment 2	0.00 ~ 50.00	%/s	0.30	●	0x1B0F
F27.16	Feedforward increment 3	0.00 ~ 50.00	%/s	0.75	●	0x1B10
F27.17	Feedforward increment 4	0.00 ~ 50.00	%/s	1.55	●	0x1B11
F27.18	Feedforward increment 5	0.00 - 50.00	%/s	4.00	●	0x1B12
F27.19	Feedforward increment 6	0.00 - 50.00	%/s	11.00	●	0x1B13

**F27.13 Soft start increment:**

Feedforward change rate within the first period of F09.21.

**F27.07 Feedforward increment 1:**

Feedforward change rate corresponding to the deviation of F27.07 ~ F27.08.

**F27.12 Feedforward increment 6:**

Feedforward change rate corresponding to the deviation of F27.12 ~ 100.00%..

Function code	Function code name	Parameter description	Unit	Default setting	Attribute	Mailing address
F27.20	Material cutoff control mode	<p><b>Ones place:</b> disconnection detection mode                      0: automatic detection                      1: external signal</p> <p><b>Tens place:</b> material cutoff detection control                      0: detect when the output is greater than the lower limit of material cutoff detection                      1: no detection</p> <p><b>Hundreds place:</b> material cutoff handling mode                      0: protection of terminal action only                      1: delayed stop and protection report</p> <p>2: material cutoff protection                      3: automatic reset of material cutoff protection                      4: material cutoff detection terminal output only                      5: automatic reset of material cutoff detection terminal</p> <p><b>Thousands place:</b> brake mode                      0: mode 0                      1: mode 1</p> <p><b>Myriabit:</b> reverse unwinding mode                      0: no speed limit                      1: reverse speed limit by F27.24</p>		11211	○	0x1B14

**Ones place of F27.20 = 0: automatic detection**

Wire disconnection is detected automatically by the inverter. In this mode, F09.35 and F09.36 must be set accurately.

**Ones place of F27.20 = 1: external signal**

Wire disconnection is detected by the external proximity switch.

**Tens place of F27.20 = 0: Detection with the output greater than the lower limit of material cutoff detection**

When the stop command is received, and the output frequency is less than the set value of

F27.22, wire disconnection will not be detected.

**Tens place of F27.20 = 1: no detection**

Wire disconnection will not be detected.

**Hundreds place of F27.20 = 0: Protection terminal action only**

In case of wire disconnection, the inverter will continue to run at the set frequency of F27.24, and only the 68# function terminal and protection output terminal will act.

**Hundreds place of F27.20 = 1: Delayed stop and trip protection**

In case of wire disconnection, the 68# function terminal and protection output terminal will act, the inverter will stop after running at the frequency of F27.24 for the time of F27.23 and then the protection will be enabled.

**Hundreds place of F27.20 = 2: Material cutoff protection**

In case of wire disconnection, the inverter will be in the protection status.

**Hundreds place of F27.20 = 3: Automatic reset of material cutoff protection**

In case of wire disconnection, the inverter will be in the protection status and reset automatically after the set delay time of F27.26.

**Hundreds place of F27.20 = 4: Only output of material cutoff detection terminal**

In case of wire disconnection, the inverter will not be subject to trip protection, and only the output terminal for material cutoff detection output will be valid.

**Hundreds place of F27.20 =5: Automatic resetting of material cutoff detection terminal**

This is the same as the option 4. The terminal of material cutoff detection output is invalid only when the swing rod returns to the normal range.

**Thousands place of F27.20 = 0: Mode 0**

Mode 0: When the output frequency is within the brake signal output frequency (F27.25) from top to bottom, the brake will not work.

**Thousands place of F27.20 = 1: Mode 1**

Mode 1: When the output frequency is within the brake signal output frequency (F27.25) from top to bottom, the brake will work.

**Ten hundreds places of F27.20 = 0: no speed limit**

There is no reverse speed limit.

**Ten hundreds places of F27.20 = 1: reverse speed limit by F27.24**

There is no reverse speed limit by F27.24.

Function code	Function code name	Parameter description	Unit	Default setting	Attribute	Mailing address
F27.21	Material cutoff detection delay	0.0~10.0	s	6.0	●	0x1B15

When the inverter receives the running command, wire disconnection detection will be performed after the set time.

Function code	Function code name	Parameter description	Unit	Default setting	Attribute	Mailing address
---------------	--------------------	-----------------------	------	-----------------	-----------	-----------------

F27.22	Lower limit of material cutoff detection after parking	0.00~60.00	Hz	5.00	●	0x1B16
--------	--	------------	----	------	---	--------

If the tens place of F27.20 is set to 0 and the inverter decelerates to this frequency, wire disconnection will not be detected.

(This function will not be enabled until the output frequency of the inverter must exceed this frequency after the soft start time and be lower than this frequency after deceleration.)

Function code	Function code name	Parameter description	Unit	Default setting	Attribute	Mailing address
F27.23	Time of continuous running after material cutoff	0.0 ~ 60.0	s	10.0	●	0x1B17
F27.24	Frequency of continuous running after material cutoff	0.00~Fmax	Hz	5.00	●	0x1B18

The set time of F27.23 is calculated when the wire disconnection is identified. According to the setting of F27.24, the operating frequency in this period is reverse during unwinding and positive during winding.

Function code	Function code name	Parameter description	Unit	Default setting	Attribute	Mailing address
F27.25	Brake signal output frequency	0.00~Fup	Hz	2.50	●	0x1B19
F27.26	Braking signal duration	0.0~100.0	s	5.0	●	0x1BA

F27.25 and F27.26 are not valid until one output terminal is defined as “brake control” (67# function).

When the output frequency of the inverter drops to the set value of F27.25, the brake control terminal will be valid and maintained (the brake mode 1 is enabled).

It will be invalid after the set time of F27.26. When the brake control terminal is valid, the inverter will stop freely.

There is no response to the running command when the brake control terminal is valid.

If F27.26 is set to 0.0, the brake control terminal will remain valid and can be reset by the brake reset terminal or protection reset terminal.

Function code	Function code name	Parameter description	Unit	Default setting	Attribute	Mailing address
---------------	--------------------	-----------------------	------	-----------------	-----------	-----------------

F27.27	Minimum frequency of wiring detection	0.00~20.00	Hz	10.00	●	0x1B1B
F27.28	Judgment time for invalid cable signal	0.1 ~ 20.0	s	10.0	●	0x1B1C
F27.29	Judgment time for valid cable signal	0.1 ~ 20.0	s	2.0	●	0x1B1D

When the input terminal is set to “122: wiring detection signal”, F27.27 ~ F27.29 will be valid.

When the output frequency of the inverter reaches the set value of F27.27, wiring detection will be started.

If the wiring detection terminal is valid within the set time of F27.28, the wiring switch will be considered invalid.

If the wiring detection terminal is always valid within the set time of F27.29, the wiring pole will stop moving.

If the wiring pole protection is detected, the inverter will report E44 protection and stop freely.

Function code	Function code name	Parameter description	Unit	Default setting	Attribute	Mailing address
F27.30	Filtering time for material cutoff detection	1 ~ 100	ms	5	●	0x1B1E

The set time of this function is the filtering time of material cutoff detection. It is valid simultaneously for automatic material cutoff detection and external material cutoff detection.

Function code	Function code name	Parameter description	Unit	Default setting	Attribute	Mailing address
F27.36	Current value of feedforward gain	-500.0~500.0	%		×	0x1B24

This function code is used to view the current feedforward gain.

## 7.22 F45 Modbus free mapping parameter group

Function code	Function code name	Parameter description	Unit	Default setting	Attribute	Mailing address
F45.00	Modbus	0: invalid		0	●	0x2D00



	communication mapping	1: valid				
F45.01	Source address 1	0~65535		0	●	0x2D01
F45.02	Destination address 1	0~65535		0	●	0x2D02
F45.03	Mapping coefficient 1	0.00~100.00		1.00	●	0x2D03

### (1) Modbus communication free mapping function

By mapping any function code to the internal function code of the inverter, the Modbus communication function can be used normally without changing the original PLC program.

To use the communication mapping function, F45.00=1 must be set. Otherwise, the function is invalid. To disable the mapping function, it can directly set F45.00=0.

In total, it can be mapped 30 groups of function codes, and 3 function codes need to be set for each group:

1. Source address: Indicates the source address to be mapped
2. Destination address: the source address is mapped to an internal function code address
3. Mapping coefficient: If the source address and destination address data have different decimal points, you can adjust the mapping coefficient. If the decimal points are the same, you do not need to change them.

### (2) Rules of Mapping address translation

The mapping addresses are all set in base 10, and the conversion rules are as follows: Map F15.38 to F18.22. First, the source address F15.38 index 15 is converted to hexadecimal 0FH, and the sub-index 38 is converted to hexadecimal 26H, which is combined to 0F26H, and then converted to the corresponding decimal 3878. Convert destination address F18.22 index 18 to hexadecimal 12H, sub-index 22 to hexadecimal 16H, synthesized to 1216H, and then converted to the corresponding hexadecimal 4630, then the function code is set as follows:

F45.00=1 (mapping function valid)

F45.01=3878 (source address F15.38)

F45.02=4630 (destination address F18.22)

### (3) Mapping coefficient

When the decimal points of the source address and destination address are inconsistent, it can be adjusted by the mapping coefficient. All parameters are readable. Therefore, the mapping coefficient is set by default when reading parameters, which is automatically converted internally when writing parameters, and does not need to set the write coefficient separately.

When reading inverter parameters, the data is multiplied by the mapping coefficient and sent to PLC; when writing parameters, the inverter receives the data and divides it by the

mapping coefficient.

If read the output frequency of the inverter, the source address is F10.00=50.0Hz, and the destination address is F00.07=50.00Hz, the mapping coefficient needs to be set to 0.10. The data returned to PLC by inverter: destination address data \* mapping coefficient = 5000 \* 0.1 = 500, consistent with the number of decimal places of source address F10.00. When writing the output frequency of the inverter, PLC sends data 500, and the inverter receives data as: 500/0.1 = 5000, consistent with the destination address F00.07 decimal places.

The principle of mapping coefficient setting: Regardless of whether a parameter is read or written, the mapping coefficient is set according to reading the parameter.

**(4) Examples of mapping functions**

**4.1 Mapping an External Address to an Internal Address with the Same Function**

When replacing the communication function of EM303B inverter, it is necessary to write the acceleration and deceleration time. The EM303B acceleration and deceleration time function codes are F00.09 and F00.10, and the EM730 acceleration and deceleration time function codes are F00.14 and F00.15. The original PLC program communication to F00.09 and F00.10 address write deceleration time, in the case of PLC program does not change, EM730 and PLC can be achieved through the mapping function of normal communication. Map F00.09 and F00.10 to F00.14 and F00.15 respectively.

Source address 1	F00.09 (0009H/9D)	Destination address 1	F00.14 (000EH/14D)	Acceleration time
Source address 2	F00.10 (000AH/10D)	Destination address 2	F00.15 (000FH/15D)	Deceleration time

Mapping parameters are set as follows:

F45.00=1 (mapping function valid)

F45.01=9 (source address 1)

F45.02=14 (Destination address 1)

F45.04=10 (source address 2)

F45.05=15 (Destination address 2)

After the above parameters are set, the EM730 inverter converts internally to F00.14 when receiving the PLC write address F00.09, and to F00.15 when receiving the PLC write address F00.10, realizing normal acceleration and deceleration time modification. If the address mapping is incorrectly set, the acceleration and deceleration time of EM730 inverter cannot be changed, and the function codes F00.09 and F00.10 of EM730 will be incorrectly changed.

#### 4.2 Sending a frame of discontinuous addresses using the address mapping function

PLC needs to read EM730 inverter data, including output frequency, output current, PID given, digital input terminal state. As the above four data addresses are discontinuous, PLC needs to send 4 frames of data to read respectively, through the address mapping function can realize PLC send a frame of data to read the above 4 original discontinuous data. Map F18.00, F18.01, F18.02, and F18.03 to F18.00, F18.06, F18.16, and F18.22 respectively.

Source address 1	F18.00 (1200H/4608D)	Destination address 1	F18.00 (1200H/4608D)	Output frequency
Source address 2	F18.01 (1201H/4609D)	Destination address 2	F18.06 (1206H/4614D)	Output current
Source address 3	F18.02 (1202H/4610D)	Destination address 3	F18.16 (1210H/4624D)	PID given
Source address 4	F18.03 (1203H/4611D)	Destination address 4	F18.22 (1216H/4630D)	Digital input terminal state

Mapping parameters are set as follows:

F45.00=1 (mapping function is valid)

F45.01=4608 (Source address 1)

F45.02=4608 (destination address 1)

F45.04=4609 (Source address 2)

F45.05=4614 (destination address 2)

F45.07=4610 (Source address 3)

F45.08=4624 (Destination ADDRESS 3)

F45.10=4611 (source address 4)

F45.11=4630 (destination address 4)

## 7.22 Water supply application macro description

### Function introduction

1. After selecting the water supply macro, the status parameters that need to be paid attention to in water supply have been preset: output frequency, set pressure, feedback pressure, output current, analog feedback AI2 value (%), press the shift key to switch.

2. After selecting the water supply macro, you can adjust the given pressure by rotating the

potentiometer (unit light: Hz+A represents bar).

3. The unit of water supply pressure is kilogram force (bar). Water pressure conversion relationship: 1bar (bar) = 0.1Mpa (megapascal) = 100kPa (kilopascal) ≈ 1kg/cm<sup>2</sup> (kilogram/square centimeter)

4. Use acceleration time 1 to accelerate at startup, and preset P and I parameters to make the water pump motor accelerate quickly.

5. Added a special sleep frequency (F09.45), the factory value is closed, please set F09.27 sleep control if necessary  
 Selection = 3 sealed pipe sleep.

**Wiring diagram for water supply application macro**

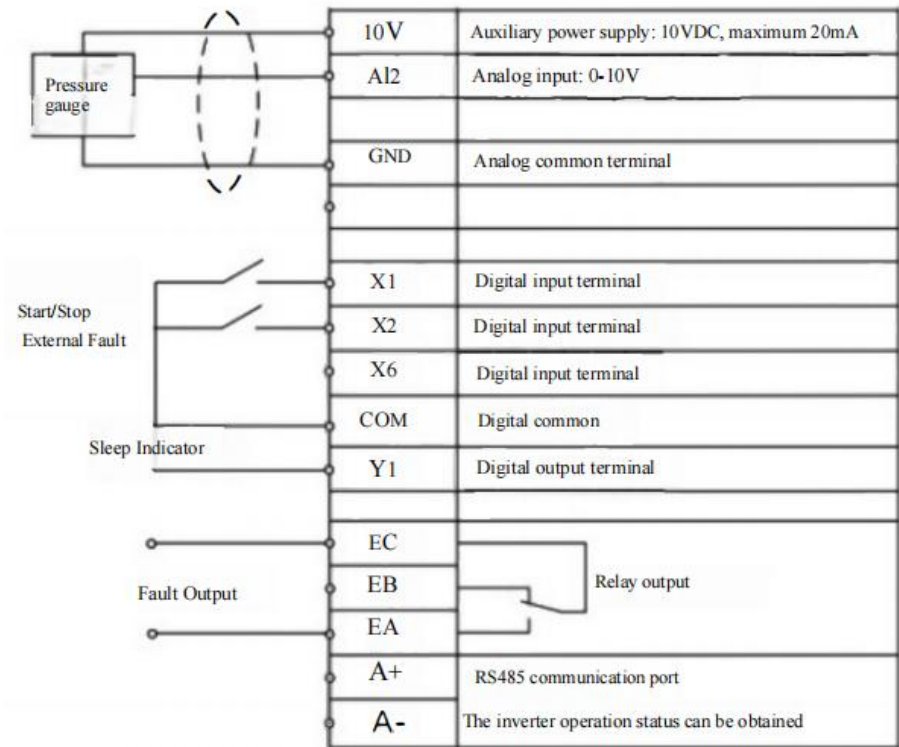

Wiring corresponding to application macro F16.00=1 (remote pressure gauge voltage feedback mode)

Note: The factory command source is keyboard control. If you need to change to terminal control, please modify F00.02

## **Debugging process**

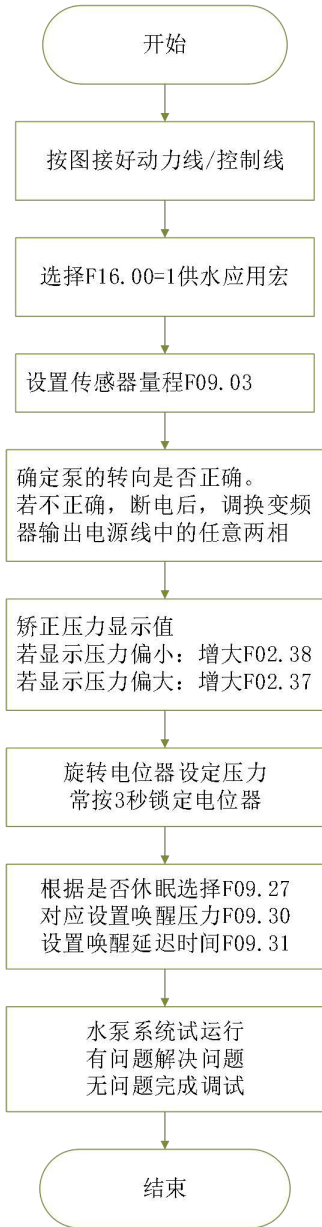

**Improve the usability of water supply**

1. After selecting the water supply macro, the status parameters that need to be paid attention to in water supply have been preset. They are: output frequency, setting

Pressure, feedback pressure, output current, the shift key can cyclically switch the above state values. You can skip the set parameters by setting 0.00 through F12.33- F12.37 to reduce the length of the shift key switching cycle. The set pressure and feedback pressure units are bar, and the corresponding Hz+A lights are on at the same time. The set pressure Hz+A light flashes, and the feedback pressure Hz+A light is always on.

2. After selecting the water supply macro, the rotary potentiometer becomes to adjust the given pressure. The setting is effective immediately. If you do not press the confirmation key, the power will not be saved. Press the confirmation key to save the set pressure value and update the F09.01 target pressure setting. The external LCD keyboard can adjust the given pressure through the up and down keys in the monitoring interface. After the given value is set, the power will be turned off by default to save the given value.

3. After the rotary potentiometer changes the set pressure, in the running state, it will immediately switch to the output frequency display state if there is no operation for about 1.5 seconds.

4. Press and hold the confirmation key on the EM730 potentiometer for 3 seconds to lock the digital potentiometer's ability to adjust the given pressure. The keyboard displays Lock to prevent the set pressure from being changed by mistake. If the rotary potentiometer displays Lock, the potentiometer setting pressure has been locked. Press and hold the confirmation key for 3 seconds again to unlock the pressure setting of the digital potentiometer. The keyboard displays uLock. The pump startup process is based on the acceleration time. Acceleration time 1 is used for acceleration at startup. F00.14 acceleration time 1 = 10s, F00.15 deceleration time 1 = 15s are preset at the factory, and P and I parameters are preset to accelerate the pump motor quickly. For faster acceleration, you can appropriately reduce acceleration time 1, but do not set acceleration time 1 too small. Sleep wake-up logic

Sleep logic: When the feedback pressure is greater than the set pressure, the frequency starts to decrease. When the output frequency is less than the sleep frequency (F09.45),

then after the sleep delay time (F09.29, the constant pressure PID adjustment is performed throughout the process), the tube is sealed and the sleep state is entered (the factory value turns off the sleep state. If you need to sleep, please set F09.27=3). After entering the sleep state, the

keyboard displays SLEEP, and SLEEP disappears automatically after wake-up.

It has a sleep indication digital output signal (the Y1 output terminal has been set to: No. 59 function sleep indication), which can be used to control the sleep small pump.

Wake-up logic: When the feedback pressure is less than the wake-up pressure (F09.30), after the wake-up delay time (F09.31), wake up.

The entire sleep wake-up logic is shown in the figure below.

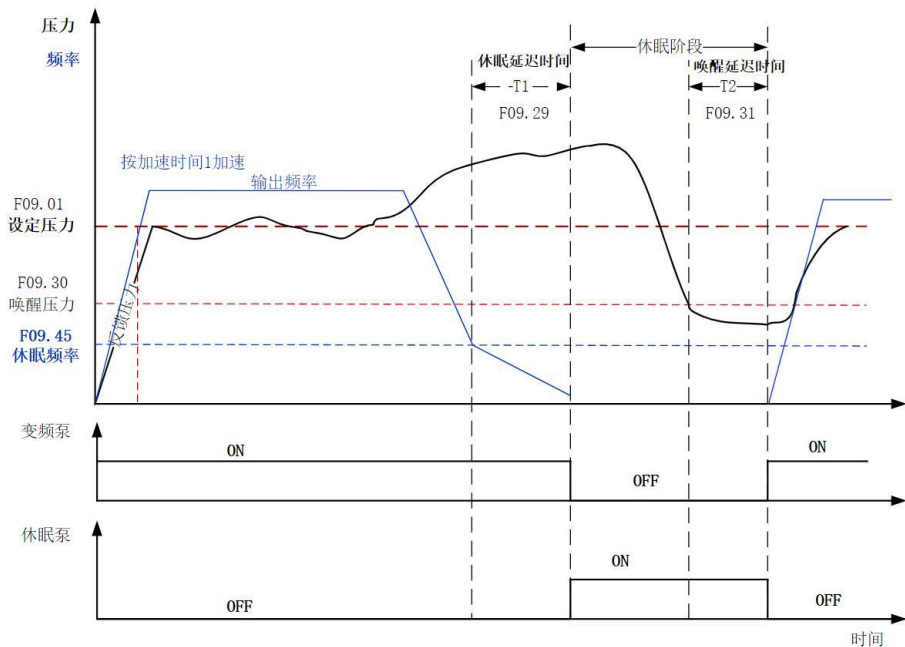

**Sleep wake-up logic diagram**

**Notes**

If you want to select sleep to be effective, please modify F09.27=3 in the shutdown state to seal the dormant pipe. Modification in the running state is invalid.

If debugging finds that the time to enter the dormant state is too long, the F09.46 pressure feedback increment value can be appropriately increased.

If F09.27=3 is modified in the shutdown state and it still does not sleep, the PID adjustment dead zone value of F09.47 can be appropriately increased.

**Complete parameter table corresponding to the EM730 water supply application macro**



Open the water supply application macro default startup process PID (F00.05), instantaneous stop without stopping (F07.06), and normal fault retry(F07.14). The sleep/wake-up (F09.27) and pipe network overpressure alarm functions (F09.42) are turned off by default. If there are functions that need to be adjusted, refer to the following table for changes.

Function code	Function code name	Parameter description	Unit	Default setting
F00.02	Options of command source	F00.02=0: keyboard control (LOC/REM indicator ON) 1: terminal control (LOC/REM indicator: OFF) 2: communication control (LOC/REM indicator: flicker)		0
F00.05	Options of auxiliary frequency source B	0: digital frequency setting F00.07 1: AI1 2: AI2 3: reserved 4: reserved 5: high frequency pulse input (X5) 6: percent setting of auxiliary frequency communication 7: direct setting of auxiliary frequency communication 8: digital potentiometer setting 9: reserved 10: process PID 11: simple PLC		0
F00.06	Options of frequency source	0: main frequency source A 1: auxiliary frequency source B 2: main and auxiliary operation results 3: switching between main frequency source A and auxiliary frequency source B 4: switching between main frequency source A and main and auxiliary operation results 5: switching between auxiliary frequency source B and main and auxiliary operation results 6: auxiliary frequency source B + feedforward calculation (winding application)		0
F00.14	Acceleration time 1	0.00 ~ 650.00 (F15.13=0) 0.0 ~ 6500.0 (F15.13=1)	s	15.00

		0 ~ 65000 (F15.13=2)		
F00.15	Deceleration time 1	0.00 ~ 650.00 (F15.13=0) 0.0 ~ 6500.0 (F15.13=1) 0 ~ 65000 (F15.13=2)	s	15.00
F00.16	Maximum frequency	1.00~600.00/1.0~3000.0	Hz	50.00
F00.18	Upper frequency limit	lower frequency limit F00.19 to maximum frequency F00.16	Hz	50.00
F00.19	Lower frequency limit	0.00 to upper frequency limit F00.18	Hz	0.00
F00.21	Reverse control	0: allow forward/reverse running 1: prohibit reversing		1
F00.30	Load Type	1: Light load		1
F02.00	X1 Digital input function selection	1: Run terminal RUN		1
F02.01	X2 Digital input function selection	23: External fault input Can be connected to the external water shortage signal terminal		23
F02.37	Curve 2 Minimum Input	-10.00V~F02.39	V	0.00
F02.38	Curve 2 Minimum input corresponding to Given	- 100.0~+100.0	%	0.0
F02.39	Curve 2 Maximum Input	F02.37~10.00V	V	10.00
F02.40	Curve 2 Maximum input corresponding to Given	- 100.0~+100.0	%	100.0
F02.62	Analog input AI1 type selection	0: 0~10V 4: 0~5V		0
F02.63	Analog input AI2 type selection	0: 0~10V 1: 4~20mA 2: 0~20mA 4: 0~5V		0
F03.00	Y1 output function	59: Sleep indication		59

	selection	Can be connected to the relay that controls the sleep pump		
F03.02	R1 output function selection	7: Fault output		7
F05.00	V/F curve setting	4: Square V/F curve		4
F07.06	Bus voltage control selection	Units: Instantaneous stop without stopping function selection 0: Invalid 1: Deceleration Tens: Overvoltage stall function selection 1: Valid		11
F07.14	Failure retry times	0 to 20 times, 0: Retry is prohibited 5 retries are allowed for normal faults		5
F07.16	Failure retry interval	30s		30.00
F09.00	PID given source	0: Digital PID given F09.01		
<b>F09.01</b>	<b>Target pressure setting</b>	<b>0.00~Pressure sensor range F09.03</b>	<b>bar</b>	3.00
F09.02	PID feedback source	1: AI1 2: AI2		2
F09.03	Pressure sensor range	<b>0.01~600.00</b>	<b>bar</b>	10.00
F09.05	Proportional gain 1	0.00~100.00		3.00
F09.06	Integration time 1	0.000~30.000, 0.000: no integration	s	1.00
F09.07	Derivative time 1	0.000~30.000	ms	0.000
F09.27	Sleep control selection	0: No sleep 3: Sealed tube sleep		0
F09.29	Sleep delay time	0.0~6500.0	s	60.0
F09.30	Wake-up stress	0.00~Pressure sensor range F09.03	<b>bar</b>	2.00
F09.31	Wake-up delay time	0.0~6500.0 (0.0 turns off wake-up)	s	0.5
F09.39	Wake-up method selection	0: Target pressure F09.01*wake-up pressure Coefficient 1: Wake-up pressure (F09.30)		1

F09.40	Wake-up stress coefficient	0.0~100.0 (100.0 corresponds to F09.01)	%	80.0
F09.41	Pipeline network overpressure alarm pressure	0.00~Pressure sensor range F09.03	bar	8.00
F09.42	Overpressure protection action time	0~3600 (0 is invalid)	s	0
F09.44	Sleep mode selection	0: Sleep according to sleep frequency (F09.45) 1: Sleep according to sleep action point Sleep (F09.28)		0
F09.45	Sleep frequency	0.00~Upper frequency limit F00.18	Hz	30.00
F09.46	Pressure feedback increment	0~100		5
F09.47	PID adjustment dead zone	0.00~600.00	bar	0.02
F12.33	Running status display parameter 1	Display output frequency F18.00	Hz	F18.00
F12.34	Running status display parameter 2	Display set pressure F18.16	bar	F18.16
F12.35	Running status display parameter 3	Display feedback pressure F18.17	bar	F18.17
F12.36	Running status display parameter 4	Display output current F18.06	A	F18.06
F12.37	Running status display parameter 5	Display analog feedback AI2 value F18.27	V	F18.27

# Chapter 8 Motor Parameter Self-identification

## 8.1 Motor Parameter Self-identification

When the vector control mode is selected, the motor parameters must be self-identified. For non-vector control, it is recommended to perform parameter self-identification during the first run in order to improve the control accuracy.

The motor parameters required for calculation in vector control are usually not available to users. The EM730 series inverter has the function of motor parameter self-identification. When the self-identification is enabled, the inverter will automatically test the relevant parameters of the connected motor and store them into the internal memory. Fig. 8-18 shows the specific meanings of the parameters of the three-phase asynchronous motor.

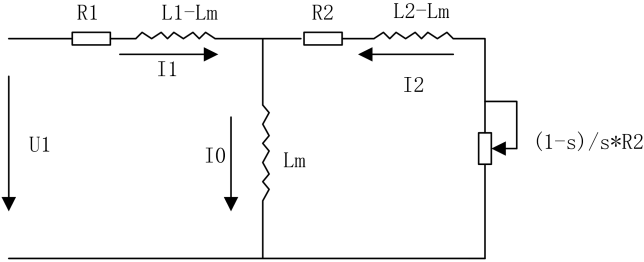

Fig. 8-18 Equivalent Circuit of Three-phase Asynchronous Motor



$R_1$ ,  $R_2$ ,  $L_1$ ,  $L_2$ ,  $L_m$ , and  $I_0$  in the figure represent: stator resistance, rotor resistance, stator self-inductance, rotor self-inductance, mutual inductance, and no-load excitation current. The leakage inductance is  $L_s = L - L_m$ .





## 8.2 Precautions before Self-identification

- Motor parameter self-identification is a process of automatically measuring motor parameters. The EM730 series inverter can perform the static and rotary self-identification of motor parameters.
  - The static self-identification is applicable when the motor load cannot be removed but the motor parameters are available.

- The rotary self-identification is suitable when the motor load can be removed. The motor shaft needs to be disconnected from the load before operation. The rotary self-identification must not be performed when the motor is under load.
- Prior to self-identification, make sure that the motor is stopped; otherwise, self-identification cannot be performed properly.
- Self-identification is valid only in the keyboard control mode (eg. F00.02=0).
- In order to ensure the normal self-identification of motor parameters, the nameplate parameters (F01.00: motor type; F01.01: rated power of the motor; F01.02: rated voltage of the motor; F01.03: rated current of the motor; F01.04: rated frequency of the motor; F01.05: rated speed of the motor; F01.06: winding connection of the motor; F01.07: rated power factor of the motor) of the controlled motor should be set correctly. When the Y series motor is used based on the specified power of the inverter, its default settings can meet most requirements.
- In order to ensure the control performance, the power of the motor should match with that of the inverter, or the former should be one level lower than the latter under normal circumstances.
- After the normal self-identification of motor parameters, the set values of F01.09 to F01.13 and F01.19 to F01.22 will be updated and automatically saved.
- When F12.14=1 is restored to the default setting, the values of the function codes F01.00 to F01.13 and F01.19 to F01.22 remain unchanged.

### 8.3 Self-identification Steps

- Set F00.02=0 in the parameter setting status and disconnect the motor from the load.
- According to the motor nameplate parameters, set F01.00 (motor type), F01.01 (rated power of the motor), F01.02 (rated voltage of the motor), F01.03 (rated current of the motor), F01.04 (rated frequency of the motor), F01.05 (rated speed of the motor), F01.06 (winding connection of the motor) and F01.07 (rated power factor of the motor), respectively.
- For the asynchronous motor:  
Set F01.34=1 and press . The inverter will start the static self-identification of the motor. Or, set F01.34=2 and press . The inverter will start the rotary self-identification of the motor.

- For the synchronous motor:  
Set F01.34=11 and press . The inverter will start the static self-identification of the motor. Or, set F01.34=12 and press . The inverter will start the rotary self-identification of the motor.
- It takes about two minutes to complete the self-identification of the motor. Then the system will return to the initial power-on status.
- During the self-identification, if you press the STOP/RESET key , “E24” (parameter identification abnormality) will be displayed; and if you press the STOP/RESET key , the system will return to the parameter setting status.  
If the self-identification fails, “E24” (parameter identification abnormality) will be displayed. If the STOP/RESET key is pressed , the system will return to the parameter setting status.

## Chapter 9 Protection/Warning Solutions

### 9.1 Protection content

When the inverter is in the abnormal status, the digital tube display will show the corresponding protection code and its parameters, the protection relay and protection output terminal will work, and the inverter will stop the output. In case of protection, the motor will stop rotating normally or slow down until it is stopped. The protection contents and solutions of the EM730 series inverter are shown in Table 9-26.

Table 9-26 Protection Contents and Solutions of EM730 Series Inverter

Protection code	Protection Type	Protection Cause	Protection Solution
E01	Short circuit protection	<ol style="list-style-type: none"> <li>1. Short circuit to the ground.</li> <li>2. Inter-phase short circuit</li> <li>3. Short circuit of the external braking resistor.</li> <li>4. The acceleration and deceleration time is too short.</li> <li>5. The inverter module is damaged.</li> <li>6. There is excessive on-site interference.</li> </ol>	<ol style="list-style-type: none"> <li>1. Check the wiring for short circuits.</li> <li>2. Properly increase the acceleration and deceleration time.</li> <li>3. Investigate the cause and reset the controller after implementing the corresponding solutions.</li> <li>4. Seek technical support.</li> </ol>
E02	Instantaneous overcurrent	<ol style="list-style-type: none"> <li>1. The acceleration and deceleration time is too short.</li> <li>2. In the V/F drive mode, the V/F curve setting is unreasonable.</li> <li>3. The motor is running during startup.</li> <li>4. The motor used is beyond the capacity of the inverter or the load is too heavy.</li> <li>5. Motor parameters are not suitable and need to be identified.</li> <li>6. The phases on the output side of the inverter are short-circuited.</li> <li>7. The inverter is damaged.</li> </ol>	<ol style="list-style-type: none"> <li>1. Increase the acceleration and deceleration time.</li> <li>2. Reasonably set the V/F curve.</li> <li>3. Enable speed tracking or start DC braking.</li> <li>4. Use the appropriate motor or inverter.</li> <li>5. Identify the motor parameters.</li> <li>6. Check the wiring for short circuits.</li> <li>7. Seek technical support.</li> </ol>
E04	Steady-state overcurrent	The same as E02	The same as E02



E05	Overvoltage	<ol style="list-style-type: none"> <li>1. The deceleration time is too short, and the motor has too much regenerated energy.</li> <li>2. The braking unit or braking resistor forms an open circuit.</li> <li>3. The braking unit or braking resistor does not match.</li> <li>4. The power voltage is too high.</li> <li>5. The energy consumption braking function is not enabled</li> </ol>	<ol style="list-style-type: none"> <li>1. Increase the deceleration time.</li> <li>2. Check the wiring of the braking unit and braking resistor.</li> <li>3. Use a suitable braking unit/braking resistor.</li> <li>4. Reduce the power voltage to the specified range.</li> <li>5. For the model of the built-in braking unit, set F15.30 to 1, and enable the energy consumption braking.</li> </ol>
E06	Undervoltage	<ol style="list-style-type: none"> <li>1. The input power supply is subject to phase loss.</li> <li>2. The terminals of the input power supply are loose.</li> <li>3. The voltage of the input power supply drops too much.</li> <li>4. The switch contacts of the input power supply are aging.</li> </ol>	<ol style="list-style-type: none"> <li>1. Check the input power supply and wiring.</li> <li>2. Tighten the screws of input terminals.</li> <li>3. Check the air circuit breaker and contactor.</li> </ol>
E07	Input phase loss	<ol style="list-style-type: none"> <li>1. The input power supply is subject to phase loss.</li> <li>2. The input power supply fluctuates greatly.</li> </ol>	<ol style="list-style-type: none"> <li>1. Check the input power supply.</li> <li>2. Check the wiring of the input power supply.</li> <li>3. Check whether the terminal is loose</li> <li>4. Use a voltage regulator on the input side.</li> </ol>
E08	Output phase loss	<ol style="list-style-type: none"> <li>1. The output terminals U, V and W have phase losses.</li> </ol>	<ol style="list-style-type: none"> <li>1. Check the connection between the inverter and motor.</li> <li>2. Check whether the output terminal is loose.</li> <li>3. Check whether the motor winding is disconnected.</li> </ol>
E09	Inverter overload	<ol style="list-style-type: none"> <li>1. The acceleration and deceleration time is too short.</li> <li>2. In the V/F drive mode, the V/F curve setting is unreasonable.</li> <li>3. The load is too heavy.</li> <li>4. The braking time is too long, the braking intensity is too high, or DC braking is enabled repeatedly.</li> </ol>	<ol style="list-style-type: none"> <li>1. Increase the acceleration and deceleration time.</li> <li>2. Reasonably set the V/F curve.</li> <li>3. Use the inverter that matches the load.</li> <li>4. Reduce the braking time and braking intensity. Do not enable DC braking repeatedly.</li> </ol>

E10	Inverter overheat	<ol style="list-style-type: none"> <li>1. The ambient temperature is too high.</li> <li>2. The inverter is subject to poor ventilation.</li> <li>3. The cooling fan fails.</li> </ol>	<ol style="list-style-type: none"> <li>1. The operating environment of the inverter should meet the specifications.</li> <li>2. Improve the ventilation environment and check whether the air duct is blocked.</li> <li>3. Replace the cooling fan.</li> </ol>
E11	Parameter setting conflict	<ol style="list-style-type: none"> <li>1. There is a logic conflict in parameter settings.</li> </ol>	<ol style="list-style-type: none"> <li>1. Check whether parameters set is illogical before the protection.</li> </ol>
E13	Motor overload	<ol style="list-style-type: none"> <li>1. The acceleration and deceleration time is too short.</li> <li>2. In the V/F drive mode, the V/F curve setting is unreasonable.</li> <li>3. The load is too heavy.</li> </ol>	<ol style="list-style-type: none"> <li>1. Increase the acceleration and deceleration time.</li> <li>2. Reasonably set the V/F curve.</li> <li>3. Use a motor matching the load.</li> </ol>
E14	External protection	<ol style="list-style-type: none"> <li>1. The protection terminal of the external device acts.</li> </ol>	<ol style="list-style-type: none"> <li>1. Check the external device.</li> </ol>
E15	Inverter memory protection	<ol style="list-style-type: none"> <li>1. Interference results in memory reading and writing errors.</li> <li>2. The internal memory of the controller is read and written repeatedly, causing damage to the memory.</li> </ol>	<ol style="list-style-type: none"> <li>1. Press the STOP/RESET key to reset the controller and try again.</li> <li>2. For the parameters (e.g. frequency setting) to be modified frequently, set F10.56 to 11 after debugging.</li> </ol>
E16	Communication error	<ol style="list-style-type: none"> <li>1. Communication timeout is enabled in the discontinuous communication system.</li> <li>2. Communication is disconnected.</li> </ol>	<ol style="list-style-type: none"> <li>1. F10.03 is set to 0.0 in the discontinuous communication system.</li> <li>2. Adjust the F10.03 communication timeout.</li> <li>3. Check whether the communication cable is disconnected.</li> </ol>
E17	Abnormality of inverter temperature sensor	The inverter temperature sensor is disconnected or short-circuited.	<ol style="list-style-type: none"> <li>1. Check whether the inverter temperature sensor is connected properly.</li> <li>2. Seek technical support.</li> </ol>
E18	The soft start relay is not engaged.	<ol style="list-style-type: none"> <li>1. The power supply fails during operation.</li> <li>2. The input power supply is subject to phase loss.</li> <li>3. The terminals of the input power supply are loose.</li> <li>4. The voltage of the input power supply drops too much.</li> <li>5. The switch contacts of the input power supply are aging.</li> </ol>	<ol style="list-style-type: none"> <li>1. Stop the inverter before power-off, or directly reset the protection.</li> <li>2. Check the input power supply and wiring.</li> <li>3. Tighten the screws of input terminals.</li> <li>4. Check the air circuit breaker and contactor.</li> </ol>

E19	Error of current detection circuit	The detection circuit of the drive board or control board is damaged.	1. Seek technical support.
E20	Stall protection	<ol style="list-style-type: none"> <li>1. The deceleration time is too short.</li> <li>2. Error of dynamic brake for deceleration.</li> <li>3. The load is too heavy.</li> </ol>	<ol style="list-style-type: none"> <li>1. Increase the deceleration time.</li> <li>2. Check the dynamic brake.</li> <li>3. Check whether the motor cannot be stopped as it is driven by another load.</li> </ol>
E21	PID feedback disconnection	<ol style="list-style-type: none"> <li>1. The PID feedback is greater than the upper limit (F09.24) or less than the lower limit (F09.25), depending on the type of the feedback sensor.</li> </ol>	<ol style="list-style-type: none"> <li>1. Check whether the feedback line falls off.</li> <li>2. Check whether the sensor is working abnormally.</li> <li>3. Adjust the detection value of feedback disconnection to a reasonable level.</li> </ol>
E24	Self-identification error	<ol style="list-style-type: none"> <li>1. Press the STOP/RESET key during parameter identification.</li> <li>2. The external terminal stops working (FRS = ON) properly during parameter identification.</li> <li>3. The motor is not connected.</li> <li>4. The rotary self-learning motor is not disconnected from the load.</li> <li>5. The motor fails.</li> </ol>	<ol style="list-style-type: none"> <li>1. Press the STOP/RESET key to reset.</li> <li>2. The external terminal should not be operated during parameter identification.</li> <li>3. Check the connection between the inverter and motor.</li> <li>4. Disconnect the rotary self-learning motor from the load.</li> <li>5. Check the motor.</li> </ol>
E26	Load loss protection	<ol style="list-style-type: none"> <li>1. The motor is not connected or does not match the load.</li> <li>2. Load loss occurs.</li> <li>3. The parameters of load loss protection are not set reasonably.</li> </ol>	<ol style="list-style-type: none"> <li>1. Check the wiring and use the appropriate motor</li> <li>2. Check the equipment.</li> <li>3. Change the off-load detection level F07.22 and detection time F07.23.</li> </ol>
E27	Up to cumulative power-on time	<ol style="list-style-type: none"> <li>1. The inverter maintenance time is up.</li> </ol>	1. Please contact the dealer for technical support.
E28	Up to cumulative running time	<ol style="list-style-type: none"> <li>1. The inverter maintenance time is up.</li> </ol>	1. Please contact the dealer for technical support.
E44	Wiring protection	<ol style="list-style-type: none"> <li>1. The valid time of the wiring detection terminal is too long.</li> <li>2. The invalid time of the wiring detection terminal is too long.</li> </ol>	<ol style="list-style-type: none"> <li>1. Check whether the sensor can work normally.</li> <li>2. Check whether the terminal is capable of properly judging the closing and opening.</li> </ol>
E57	Overpressure in pipeline network	<ol style="list-style-type: none"> <li>1. The feedback pressure in the water supply application is too</li> </ol>	1. Check whether the sensor is in the abnormal status.

		high.	2. Check the analog terminal for normal detection of analog input. 3. Check the external device.
E58	Under-pressure in pipeline network	1. The feedback pressure in the water supply application is too low.	1. Check whether the sensor is in the abnormal status. 2. Check the analog terminal for normal detection of analog input. 3. Check the external device.
E76	Short circuit to the ground	1. The output is short-circuited to ground. 2. The inverter module is damaged.	1. Check whether the output cable is broken or whether the motor shell is broken down. 2. Investigate the cause and reset the controller after implementing the corresponding solutions. 3. Seek technical support.

When the inverter is subject to the aforesaid protection, press the STOP/RESET key  to reset/clear protection or use the protection resetting terminal to exit the protection status. If the protection has been eliminated, the inverter will return to the function setting status; otherwise, the digital tube will continue to display the current protection information.

The protection number corresponds to the digit behind the letter “E”. For example, the digit corresponding to “EXX” is “XX”.

For example, E01 corresponds to 1, and E10 corresponds to 10.

**Comparison table of digital font display:**

1	2	3	4	5	6	7	8	9	0
1	2	3	4	5	6	7	8	9	0

**The prompt codes and description of inverter operation are as follows:**

Prompt Code	Description
P. -ON	The inverter is in the power-on status.
P. -OFF	The inverter is in the power-off status.
SOFT. E	If the soft starter is not engaged, the inverter will show the SOFT.E prompt after startup. When the voltage is restored and the soft starter is engaged, the inverter will work normally.

## 9.2 Protection analysis

If the motor does not work as expected due to errors in function setting and external control terminal connection after the inverter is powered on, refer to the analysis in this section for the corresponding solutions. If a protection code is displayed, see the solutions in 9.1.

### 9.2.1 Failure in parameter setting of function codes

- The displayed parameters remain unchanged during the forward or reverse spinning of the digital potentiometer.

When the inverter is in the running status, some code parameters cannot be modified without stopping the inverter.

- The displayed parameters can be modified but cannot be stored during the forward or reverse spinning of the digital potentiometer.

Some function codes are locked and cannot be modified.

When F12.02 is set to 1 or 2, parameter changes are restricted. Please set F12.02 to 0. Or, this occurs after the user password is set.

### 9.2.2 Abnormality of motor rotation

- When the RUN key  on the keyboard is pressed, the motor does not rotate.
  - Terminal control of the start and stop: Check the setting of the function code F00.02.
  - The free stop terminal FRS and COM are closed: Disconnect the free stop terminal FRS from COM.
  - Switching of the running command to terminal is valid. In this case, the running command is only subject to terminal control. This will be invalid if modified.
  - The status combination of the running command channel is terminal control: Change it to keyboard control.
  - The reference input frequency is set to 0: Increase the reference input frequency.
  - The input power supply is abnormal or the control circuit fails.
- The control terminals RUN and F/R are ON, and the motor does not rotate.
  - Enabling of the stop function by the external terminal is invalid: Check the setting of function code F00.02.
  - Free stop terminal FRS=ON: Change the free stop terminal to FRS=OFF.
  - Control switch failure: Check the control switch.

- The reference input frequency is set to 0: Increase the reference input frequency.
- The motor can only rotate in one direction.

Reverse running is prohibited: When the reverse running prohibition code F00.21 is set to 1, the inverter is not allowed for reverse running.
- The motor rotates in the opposite direction.

The output phase sequence of the inverter is inconsistent with the input phase sequence of the motor: Exchange any two of the motor wires in the power-off status to change the rotation direction of the motor.

### 9.2.3 Too long acceleration time of motor

- The current limit level is too low.

When the overcurrent limit setting is valid, and the output current of the inverter reaches the set current limit, the output frequency will remain unchanged during acceleration, until the output current is less than the limit. Then the output frequency will continue to rise. This makes the acceleration time of the motor longer than the set time. Check whether the set current limit of the inverter is too low.
- The set acceleration time is too long. Please check the acceleration time code.

### 9.2.4 Too long deceleration time of motor

- When energy consumption braking is valid:
  - The resistance of the braking resistor is too high, and the energy consumption braking power is too low, which extends the deceleration time.
  - The set value of braking rate (F15.32) is too small, which extends the deceleration time. Increase the set value of braking rate.
  - The set deceleration time is too long. Check the deceleration time code.
- When the stall protection is valid:
  - When the overvoltage stall protection is enabled, and the DC bus voltage exceeds the voltage of overvoltage stall (F07.07), the output frequency will remain unchanged; and when the DC bus voltage is lower than F07.07, the output frequency will continue to drop, which extends the deceleration time.
  - The set deceleration time is too long. Check the deceleration time code.

### 9.2.5 Electromagnetic interference and RF interference

- Since the inverter works in the high-frequency switching status, electromagnetic

interference and RF interference will be generate to the control device. The following measures can be taken.

- Reduce the carrier frequency (F00.23) of the inverter.
- Install a noise filter on the input side of the inverter.
- Install a noise filter on the output side of the inverter.
- Install a metal tube outside the cables. Install the inverter in a metal casing.
- Make the inverter and motor grounded reliably.
- Connect the main circuit and control circuit separately. Use the shielded cables in the control circuit, and connect them according to the wiring method in Chapter 3.

### 9.2.6 Action of leakage circuit breaker

- When the inverter is running, the leakage circuit breaker works.

Since the inverter outputs high-frequency PWM signals, a high-frequency leakage current will be generated. Please use the dedicated leakage circuit breaker with the current sensitivity above 30 mA. If an ordinary leakage circuit breaker is used, use a leakage circuit breaker with the current sensitivity above 200 mA and action time of more than 0.1 s.

### 9.2.7 mechanical vibration

- The inherent frequency of the mechanical system resonates with the carrier frequency of the inverter.

The motor is not faulty, but the mechanical system produces sharp resonant sounds. This is caused by the resonance between the inherent frequency of the mechanical system and carrier frequency of the inverter. Please adjust the carrier frequency (F00.23) to avoid resonance.

- The inherent frequency of the mechanical system resonates with the output frequency of the inverter.

Resonance between the inherent frequency of the mechanical system and output frequency of the inverter will lead to mechanical noise. Please use the vibration suppression function (F05.13), or install the anti-vibration rubber or take other anti-vibration measures on the motor base.

- PID control oscillation

The adjustment parameters P, Ti and Td of the PID controller are not set correctly. Please set the PID parameters again.

### **9.2.8 Motor rotation in the absence of inverter output**

- Insufficient DC braking for stop
  - The DC braking torque for stop is too small. Please increase the set value of the DC braking current for stop (F04.21).
  - The DC braking time for stop is short. Please increase the set value of the DC braking time for stop (F04.22). Under normal circumstances, please give priority to increase in the DC braking current for stop.

### **9.2.9 Inconsistency between output frequency and set frequency**

- The set frequency exceeds the upper frequency limit.

When the set frequency exceeds the set value of the upper frequency limit, the output frequency will be the upper frequency limit. Set the frequency again within the upper frequency limit range; or check whether F00.16, F00.17 and F00.18 are appropriate.



## Maintenance

### 9.3 Daily Maintenance of Inverter

The inverter may be subject to various faults due to changes in its operating environment, such as the impact of temperature, humidity, smoke, dust and the like, and ageing of internal components. Thus, daily inspection and regular maintenance should be carried out to the inverter during storage and operation.

- Check whether the components of the inverter are intact and whether the screws are tightened after transportation and before operation.
- During the normal operation of the inverter, clean dust on a regular basis and check whether the screws are tightened.
- If the inverter is not in use for a long time, it is recommended to power it on (preferably 30 min) once every six months during storage, to prevent the failure of electronic components.
- The inverter should not be used in the humid place or place with metal dust. If necessary, use the inverter in an electrical cabinet with protective measures or an on-site protective cabin.

Please check the following items during the normal operation of the inverter:

- Check the motor for abnormal sound and vibration.
- Check the inverter and motor for abnormal heating.
- Check whether the ambient temperature is too high.
- Check whether the output current is normal.
- Check whether the cooling fan of the inverter works properly.

Depending on the usage, the user needs to check the inverter on a regular basis to eliminate faults and safety hazards. Prior to the inspection, turn off the power supply and wait until the LED indicator of the keyboard is OFF, and then wait for 10min. The check content is shown in Table Table 4-27.

Table 4- 27 Content of Regular Inspection

Check Item	Check Content	Solution
Screws of main circuit terminals and control circuit terminals	Check whether the screws are loose.	Tighten the screws with a screwdriver.
Cooling fins PCB (printed circuit board)	Check whether there is dust or foreign objects.	Purge them with dry compressed air (pressure: 4-6 kg/cm <sup>2</sup> ).
Cooling fan		
Power components	Check whether there is dust.	Purge them with dry compressed air (pressure: 4-6 kg/cm <sup>2</sup> ).
Electrolytic capacitor	Check it for color changes, odor and bubbles.	Replace the electrolytic capacitor.

In order to make the inverter work properly in a long time, regular maintenance and replacement must be performed regularly based on the service life of its internal components. The service life of the components of the inverter varies depending on the operating environment and conditions. The replacement period of the inverter in Table 4-28 is for reference only.

Table 4- 28 Replacement Intervals of Inverter Components

Name of Part	Standard Replacement Interval (Year)
Cooling fan	2-3 years
Electrolytic capacitor	4-5 years
Printed circuit board	5-8 years

The operating conditions for replacement of the inverter components listed in the above table are as follows:

Ambient temperature: Annual average 30°C.

Load factor: Less than 80%.

Operating time: less than 12 hours per day.

## 9.4 Instructions for Inverter Warranty

Our company will provide warranty services for the inverter in the following cases.

The warranty applies to the inverter body only. Our company is responsible for the warranty of the inverter that fails or is damaged within 12 months during normal operation, and will charge reasonable maintenance fees after 12 months.

Certain maintenance fees will also be charged within one year in the following cases:

- The inverter is damaged due to noncompliance with the instructions in this manual during operation;
- The inverter is damaged due to flood, fire, abnormal voltage, etc.;
- The inverter is damaged as a result of incorrect wiring;
- The inverter is damaged due to unauthorized modification.

Relevant service fees will be calculated based on the actual costs.

If any, the additional agreement shall prevail.

## Chapter 10 Select accessories

### 10.1 Braking Resistor

If the speed of the controlled motor drops too fast or the motor load shakes too fast during the inverter operation, its electromotive force will charge the internal capacitor reversely via the inverter, resulting in the voltage boost at two ends of the power module. This is likely to cause damage to the inverter. The internal control of the inverter will suppress this based on the load. If the braking performance does not meet the customer requirements, an external braking resistor is needed to release energy in a timely manner. Due to the external braking resistor of energy consumption braking type, the energy will be completely dissipated to the power braking resistor. Hence, the power and resistance of the braking resistor must be selected reasonably and effectively.

The power of the braking resistor can be calculated by the following formula:

$$\text{Resistor power } P_b = \text{inverter power } P \times \text{braking frequency } D$$

D - Braking frequency. This is an estimated value, depending on the load conditions. Under normal circumstances, D is as follows:

D=10% under ordinary loads

D=5% for occasional braking loads

D = 10% to 15% for elevators

D = 5% to 20% for centrifuges

D = 10% to 20% for oilfield kowtow machines

D = 50% to 60% for unwinding and winding. It should be calculated based on the system design indicators.

D = 50% to 60% for lifting equipment with a lowering height over 100m

The recommended power and resistance for the braking resistor of the EM730 series inverter are given in the table below. The recommended resistor power is calculated based on the braking rate (10% to 20%). It is for reference only. If the inverter is used in the case of frequent acceleration/deceleration or continuous braking, the power of the braking resistor needs to be increased. The user can change the value according to the load conditions, but within the specified range.

Inverter Model	Motor (kW)	Resistance ( $\Omega$ )	Resistor Power (W)	Wire (mm <sup>2</sup> ) Connected to Resistor
EM730-0R4-2B	0.4	$\cong 360$	$\cong 200$	1
EM730-0R7-2B	0.75	$\cong 180$	$\cong 400$	1.5
EM730-1R5-2B	1.5	$\cong 180$	$\cong 400$	1.5
EM730-2R2-2B	2.2	$\cong 90$	$\cong 800$	2.5
EM730-0R7-3B	0.75	$\cong 360$	$\cong 200$	1
EM730-1R5-3B	1.5	$\cong 180$	$\cong 400$	1.5
EM730-2R2-3B	2.2	$\cong 180$	$\cong 400$	1.5
EM730-4R0-3B	4	$\cong 90$	$\cong 800$	2.5
EM730-5R5-3B	5.5	$\cong 60$	$\cong 1000$	4
EM730-7R5-3B	7.5	$\cong 60$	$\cong 1000$	4
EM730-011-3B	11	$\cong 30$	$\cong 2000$	6
EM730-015-3B	15	$\cong 30$	$\cong 2000$	6
EM730-018-3B	18.5	$\cong 30$	$\cong 2000$	6
EM730-022-3B	22	$\cong 15$	$\cong 4000$	6
EM730-030-3B	30	$\cong 10$	$\cong 4000$	6
EM730-037-3B	37	$\cong 10$	$\cong 6000$	6

- ★ The wires listed above refer to the outgoing wires of a single resistor. If resistors are connected in parallel, the bus should be enlarged accordingly. The withstand voltage of the wires should be AC 300V or above for the single-phase model and AC 450V or above for the three-phase model. Cables should be resistant to 105°C.

## 10.2 Braking unit

For the EM730 series inverters (EM730-045-3 and above), use our BR100 series braking units (power range: 18.5 ~ 160kW). The models of our braking units are as follows.

Model and specification	Application	Minimum Resistance ( $\Omega$ )	Average Braking Current $I_{av}$ (A)	Peak Current $I_{max}$ (A)	Applicable Inverter Power (kW)
	Energy				

BR100-045	consumption braking	10	45	75	18.5 ~ 45
BR100-160	Energy consumption braking	6	75	150	55 ~ 160
BR100-200	Energy consumption braking	5	100	200	185 ~ 200
BR100-315	Energy consumption braking	3	120	300	220 ~ 315
BR100-400	Energy consumption braking	3	200	400	355 ~ 450

★ When BR100-160 works with the minimum resistance, the braking unit can work continuously at the braking frequency  $D=33\%$ .

In the case of  $D>33\%$ , intermittent operation will be performed; otherwise, the over-temperature protection will be enabled.

### 10.2.1 Selection of Connecting Wires

Since all braking units and braking resistors work at high voltage ( $>400\text{VDC}$ ) and in the discontinuous status, please select appropriate wires. See Table 4-29 for the wiring specifications of the main circuit. Use the cables with the conforming insulation levels and cross-sections.

Table 4-29 Wire Specifications of Braking Units and Braking Resistors

Specification and model	Average Braking Current $I_{av}(A)$	Peak Braking Current $I_{max}(A)$	Cross-section ( $\text{mm}^2$ ) of Copper-core Cable
BR100-045	45	75	10
BR100-160	75	150	16
BR100-200	100	200	25
BR100-315	120	300	25
BR100-400	200	400	35

Flexible cables have higher flexibility. Because cables may be in contact with high-temperature devices, it is recommended to use copper-core and heat-resistant flexible cables or flame-retardant cables. The braking unit should be close to the inverter as much as possible and no more than 2m far away from the inverter. Otherwise, the DC-side cables should be twisted and used with magnetic rings to reduce radiation and inductance.

The lengths of connecting wires of the braking unit, braking resistor and inverter are shown

in Fig. 4-19.

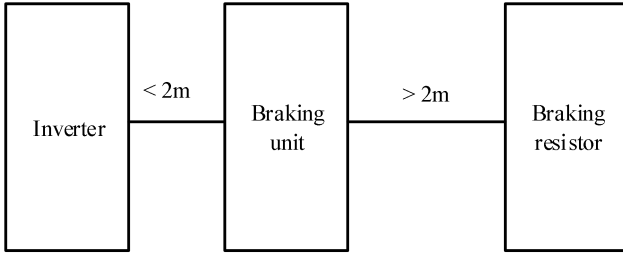

Fig. 4-19 Wire Length

### 10.3 Wi-Fi module

Applicable Wi-Fi module and model for EM730 series inverters: EM730-WIFI. The inverter can be controlled by the mobile phone APP, PC background software and the like for quick parameter setting, parameter copying and status monitoring of the inverter.

Installation of the Wi-Fi module: First unplug the keyboard from the inverter and then install the Wi-Fi module to the original keyboard position.

The external schematic diagram of the Wi-Fi module is as follows.



# Chapter 11 MODBUS Communication Protocol

## 11.1 Applicable scope

- 1、 Applicable series: EM730 series
- 2、 Applicable network: Support the “single-master multi-slave” communication network with MODBUS-RTU protocol and RS-485 bus.

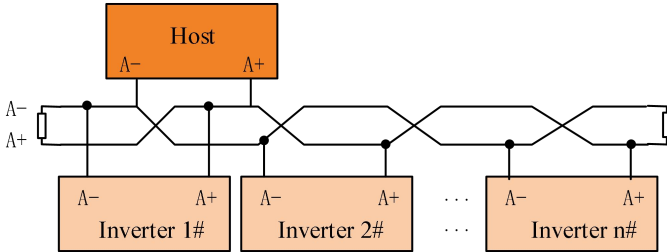

## 11.2 Interface mode

RS-485 asynchronous half-duplex communication mode, with the least significant bit sent first;

RS-485 network address: 1-247; 0 is the broadcast address;

Default data format of RS-485 terminal: 1-8-N-1<sup>[2]</sup> (options: 1-8-E-1, 1-8-O-1, 1-8-N-2, 1-8-E-2 and 1-8-O-2);

Default baud rate of RS-485 terminal: 9600bps (options: 4800bps, 19200bps, 38400bps, 57600bps and 115200bps)

It is recommended to use twisted-pair shielded cable as the communication cable to reduce the impact of external interference on communication.

[2]: 1-8-N-1, meaning 1 start bit - 8 characters per byte of data - no parity - 1 stop bit. E: even parity. O: odd parity.

## 11.3 Protocol Format

### 11.3.1 Message format

As shown in Fig. 12-20, a standard MODBUS message includes a start tag, RTU (Remote Terminal Unit) message, and end tag.



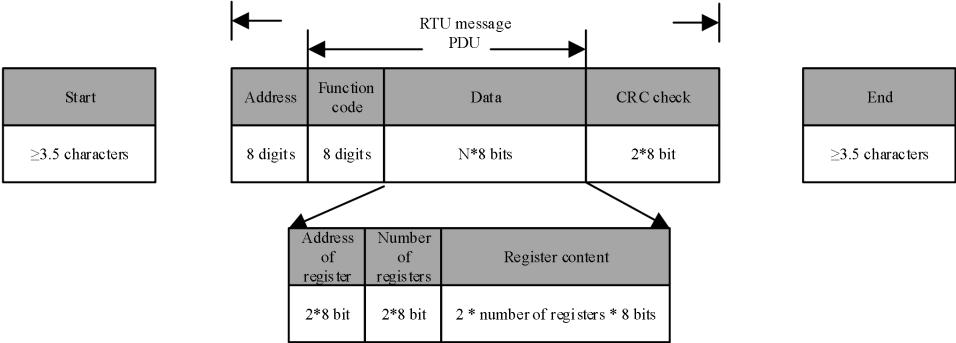

Fig. 12- 20 Schematic Diagram of Message Frame in RTU Mode

The RTU message includes the address code, PDU (Protocol Data Unit) and CRC<sup>[3]</sup> check. The PDU includes the function code and data part (mainly including the register address, number of registers, register content and the like; the detailed definitions of function codes are different, as shown in 11.3.3Function code).

[3]: the low byte of CRC check is in front of the high byte.

**11.3.2 Address code**

Address Range	Purpose
1 - 247	Slave
0	Broadcast

**11.3.3 Function code**

The classification of MODBUS function codes is shown in Fig. 12-21.

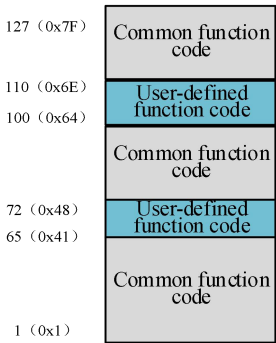

Fig. 12- 21 Classification of MODBUS Function Codes

As shown in Table 12- 30, EM730 series products mainly involve **common function codes**. For example, 0x03: function code used to read multiple registers or status words, **0x06**: function code used to write a single register or command, 0x10: function code used to write multiple registers or commands, and 0x08: function code for diagnosis.

In addition, for some specific functions, such as register writing (RAM) without EEPROM storage, the **user-defined function codes** include 0x41: function code used to write a single register or command (without saving), and 0x42: function code used to write multiple registers or commands (without saving).

When the abnormal valid data is received from a device, a related abnormality message will be returned (see 11.3.7 Exception **response**). The abnormality function code is defined to distinguish the abnormal data from normal communication data. Corresponding to the normal request function code, the **abnormality function code = request function code + 0x80**.

Table 12- 30 Function Code Definitions of EM730 series Product

Function code	Abnormality function code	Function
03	83	This function code is used to read multiple registers or status words.
41	C1	This function code is used to write a single register or command without saving.
42	C2	This function code is used to write multiple registers or commands without saving.
08	88	This function code is used for diagnosis.
06	86	This function code is used to write a single register or command.
10	90	This function code is used to write multiple registers or commands.

PDU parts are detailed in the following sections, depending on various functions.

### 1.1.1.1 0x03: function code used to read multiple registers or status words

In the remote terminal unit, this function code is used to read the content in the continuous block of the holding register. The request PDU describes the starting register address and the number of registers.

The register data in the response message is divided into two bytes in each register. The first byte of each register includes high-order bits and the second byte includes low-order bits.

● Request PDU

Function code	1 byte	<b>0x03</b>
Starting Address	2 bytes	0x0000 - 0xFFFF
Number of registers	2 bytes	1 - 16

● Response PDU

Function code	1 byte	<b>0x03</b>
Number of bytes	1 byte	2×N*
Register value	N*×2 bytes	

N\* = number of registers

● Error PDU

Error code	1 byte	<b>0x83</b>
Exception code	1 byte	01, 02, 03 or 04

Below is an example of a request to read the registers F19.00 to F19.05 (relevant information about the last protection):

Request		Respond			
Domain name	(0x)	Domain name (normal)	(0x)	Domain name (abnormal)	(0x)
Function code	03	Function code	03	Function	83
Starting address Hi	13	Number of bytes	0C	Exception code	03 (example, the same below)
Starting address Lo	00	Register value Hi (F19.00)	00		
Number (Hi) of registers	00	Register value Lo (F19.00)	11		
Number (Lo) of registers	06	Register value Hi (F19.01)	00		
		Register value Lo (F19.01)	00		
		Register value Hi (F19.02)	00		
		Register value Lo (F19.02)	00		

	Register value Hi (F19.03)	01	
	Register value Lo (F19.03)	2C	
	Register value Hi (F19.04)	00	
	Register value Lo (F19.04)	00	
	Register value Hi (F19.05)	00	
	Register value Lo (F19.05)	00	

According to the returned data, the “17 (0011H): temperature sensor abnormality protection” of the inverter is enabled, in which the output frequency is 0.00Hz, the output current is 0.00A, the bus voltage is 300V (012CH), the acceleration and deceleration status is “standby”, and the working time is 0 hour.

**★: At present, the function code 0x03 of MODBUS protocol supports the reading of multiple function codes across groups. However, it is recommended not to read them across groups in the case of no special requirements, so the customer’s software does not need to be upgraded after our products are upgraded.**

**1.1.1.2 0x41: function code used to write a single register or command (without saving)**

In the remote terminal unit, this function code is used to write a single non-holding register. The request PDU describes the address to be written to the register.

The normal response is the response made to the request, which is returned after the register content is written.

● Request PDU

Function code	1 byte	<b>0x41</b>
Address of register	2 bytes	0x0000 - 0xFFFF
Register value	2 bytes	0x0000 - 0xFFFF

● Response PDU

Function code	1 byte	<b>0x41</b>
Address of register	2 bytes	0x0000 - 0xFFFF
Register value	2 bytes	0x0000 - 0xFFFF

● Error PDU

Error code	1 byte	<b>0xC1</b>
Exception code	1 byte	SeeTable 4- 33

Below is an example of a request to change the main frequency source A (7001H) to “-50.00%”:

Request		Respond			
Domain name	(0x)	Domain name (normal)	(0x)	Domain name (abnormal)	(0x)
Function	41	Function	41	Function	C1
Register address Hi	70	Register address Hi	70	Exception code	03
Register address Lo	01	Register address Lo	01		
Register value Hi	EC	Register value Hi	EC		
Register value Lo	78	Register value Lo	78		

★ This function code cannot be used to change the parameters of the attribute “○” (it cannot be changed during operation). That is, only the parameters of the attribute “●” (it can be changed during operation) can be changed. Otherwise, the error code 1 will be returned.

**1.1.1.3 0x42: function code used to write multiple registers or commands (without saving)**

In the remote terminal unit, this function code is used to write consecutive non-holding register blocks (1 to 16 registers).

The value requested to be written is described in the request data field. The data of each register is divided into two bytes.

In the normal response, the function code, starting address and number of registers written will be returned.

● Request PDU

Function code	1 byte	<b>0x42</b>
Starting Address	2 bytes	0x0000 - 0xFFFF
Number of registers	2 bytes	1 - 16
Number of bytes	1 byte	2×N*
Register value	N*×2 bytes	

N\* = number of registers

● Response PDU

Function code	1 byte	<b>0x42</b>
Starting Address	2 bytes	0x0000 - 0xFFFF
Number of registers	2 bytes	1 - 16

● Error PDU

Error code	1 byte	<b>0xC2</b>
Exception code	1 byte	See Table 4-33

Below is an example of a request to set the acceleration time 1 (F00.14) to 5.00 and deceleration time 1 (F00.15) to 6.00:

Request		Respond			
Domain name	(0x)	Domain name (normal)	(0x)	Domain name (abnormal)	(0x)
Function	42	Function	42	Function	C2
Starting address Hi	00	Starting address Hi	00	Exception code	03
Starting address Lo	0E	Starting address Lo	0E		
Number (Hi) of registers	00	Number (Hi) of registers	00		
Number (Lo) of registers	02	Number (Lo) of registers	02		
Number of bytes	04				
Register value Hi (F00.14)	01				
Register value Lo (F00.14)	F4				
Register value Hi (F00.15)	02				
Register value Lo (F00.15)	58				

★ This function code cannot be used to change the parameters of the attribute “○” (it cannot be changed during operation). That is, only the parameters of the attribute “●” (it can be changed during operation) can be changed. Otherwise, the error code 1 will be returned.

**1.1.1.4 0x08: function code for diagnosis**

The Modbus function code 08 involves a series of tests to check the communication system between the client (master station) and server (slave station), or internal error statuses of the server.

The test to be executed is defined by the sub-function code fields of two bytes in the request. The server makes responses properly.

Copy the function codes and sub-function codes. Some diagnoses will enable the remote terminal unit to return the corresponding data through the data field in normal response.

Under normal circumstances, when the diagnosis function is sent to the remote terminal unit, the user program in this remote terminal unit will not be affected. The user logic cannot be accessed by diagnosis, such as: discrete magnitude and register. The error counter in the remote terminal unit can be remotely reset by applying some functions.

**The main diagnosis function used by our company is line diagnosis (0000), which is used to test the normal communication between the host and slave.** The normal response to a request to return query data is to return the same data. At the same time, the function codes and sub-function codes are also copied.

● Request PDU

Function code	1 byte	<b>0x08</b>
Sub-function code	2 bytes	0x0000 - 0xFFFF
Data	2 bytes	0x0000 - 0xFFFF

● Response PDU

Function code	1 byte	<b>0x08</b>
Sub-function code	2 bytes	0x0000 - 0xFFFF
Data	2 bytes	0x0000 - 0xFFFF

● Error PDU

Error code	1 byte	<b>0x88</b>
Exception code	1 byte	See Table 4-33

● Sub-function code

Sub-function	Meaning	Data field (request)	Data field (response)
0000	Return query data	Any	Copy request data
...			

**0000**: return the data transferred in the request data field in the response. All messages should be consistent with the request message.

The following table is an example of requesting the remote terminal unit to return query data. The sub-function code 0000 is used. The returned data is sent in the two-byte data field (0xA537).

Request		Respond			
Domain name	(0x)	Domain name (normal)	(0x)	Domain name (abnormal)	(0x)
Function	08	Function	08	Function	88
Sub-function code Hi	00	Sub-function code Hi	00	Exception code	03
Sub-function code Lo	00	Sub-function code Lo	00		
Data Hi	A5	Data Hi	A5		
Data Lo	37	Data Lo	37		

### 1.1.1.5 0x06: function code used to write a single register or command

In the remote terminal unit, this function code is used to write a single holding register.

The request PDU describes the address to be written to the register.

The normal response is the response made to the request, which is returned after the register content is written.

● Request PDU

Function code	1 byte	<b>0x06</b>
Address of register	2 bytes	0x0000 - 0xFFFF
Register value	2 bytes	0x0000 - 0xFFFF

● Response PDU

Function code	1 byte	<b>0x06</b>
Address of register	2 bytes	0x0000 - 0xFFFF
Register value	2 bytes	0x0000 - 0xFFFF



● Error PDU

Error code	1 byte	<b>0x86</b>
Exception code	1 byte	SeeTable 4- 33

Below is an example of a request to change the drive control mode of the motor 1 (F00.01) to “1: SVC”.

Request		Respond			
Domain name	(0x)	Domain name (normal)	(0x)	Domain name (abnormal)	(0x)
Function	06	Function	06	Function	86
Register address Hi	00	Register address Hi	00	Exception code	03
Register address Lo	01	Register address Lo	01		
Register value Hi	00	Register value Hi	00		
Register value Lo	01	Register value Lo	01		

★ The function code 0x06 cannot be used if modified frequently, in order to avoid damage to the inverter.

The user-defined function code 0x41 “change without saving” corresponds to the standard common function code 0x06. Its definition is the same as that of the corresponding standard function code (the same request, response and error PDU). The difference is that when the slave responds to this user-defined function code, the corresponding value of RAM is changed only and not stored in EEPROM (holding register).

For the function codes (e.g. F00.07) that are often modified, it is recommended to use the function code 0x41 (you can change the main frequency source A by directly setting 7001H, as detailed in 1.1.1.2 and 11.3.4), to avoid damage to the inverter. The specific operation is as follows.

Request		Respond	
Domain name	(0x)	Domain name (normal)	(0x)
Function	41	Function	41
Register address Hi	00	Register address Hi	00
Register address Lo	07	Register address Lo	07
Register value Hi	13	Register value Hi	13
Register value Lo	88	Register value Lo	88

Once the set frequency (F00.07) is set to 50.00Hz, the above data will be valid but not be stored in EEPROM. That is, the inverter will run at 50.00Hz after change but at the frequency before change if powered on again.

**1.1.1.6 0x10: function code used to write multiple registers or commands**

In the remote terminal unit, this function code is used to write consecutive register blocks (1 to 16 registers).

The value requested to be written is described in the request data field. The data of each register is divided into two bytes.

In the normal response, the function code, starting address and number of registers written will be returned.

● Request PDU

Function code	1 byte	<b>0x10</b>
Starting Address	2 bytes	0x0000 - 0xFFFF
Number of registers	2 bytes	1 - 16
Number of bytes	1 byte	2×N*
Register value	N*×2 bytes	

N\* = number of registers

● Response PDU

Function code	1 byte	<b>0x10</b>
Starting Address	2 bytes	0x0000 - 0xFFFF
Number of registers	2 bytes	1 - 16

● Error PDU

Error code	1 byte	<b>0x90</b>
Exception code	1 byte	SeeTable 4-33

Below is an example of a request to write 00 1 and 00 3 into two registers starting from F03.00 (i.e. setting the Y1 and Y2 output terminal function):

Request		Respond			
Domain name	(0x)	Domain name (normal)	(0x)	Domain name (abnormal)	(0x)
Function	10	Function	10	Function	90
Starting address Hi	03	Starting address Hi	03	Exception code	03

Starting address Lo	00	Starting address Lo	00		
Number (Hi) of registers	00	Number (Hi) of registers	00		
Number (Lo) of registers	02	Number (Lo) of registers	02		
Number of bytes	04				
Register value Hi (F03.00)	00				
Register value Lo (F03.00)	01				
Register value Hi (F03.01)	00				
Register value Lo (F03.01)	03				

★ The function code 0x10 cannot be used if modified frequently, in order to avoid damage to the inverter, as detailed in 1.1.1.5.

**11.3.4 Register address distribution**

Table 12- 31 Detailed Definition of Register Address of MODBUS Protocol

Address Space		Note	
Function code 0000H - 6F63H		For the function code FXX.YY, the high order is hexadecimal of XX and the low order is hexadecimal of YY. For example, the address of F00.14 is 000EH (00D=00H, 14D=0EH).	
Function code (not saved after power-down) 8000H-EF63H		When the parameters are set with the function code 0x06 or 0x10, the function that “the settings are valid immediately and not saved after power-down” can be realized in the form of “original address +8000H”. For example, the corresponding address of F00.14 is 800EH (=000EH+8000H).	
Control command (write only) 7000H ~ 71FFH	7000H control word	0000H	Invalid command
		0001H	Forward running
		0002H	Reverse running
		0003H	JOG forward
		0004H	JOG reverse
		0005H	Deceleration to stop
		0006H	Stop the controller quickly
		0007H	Free stop
		0008H	Reset protection
		0009H	+/- input switching
	000BH	JOG stop	

	Others to 00FFH	Reserved
7001H	Communication percentage setting of main channel frequency A	-100.00% to 100.00% (100% = maximum frequency)
7002H	Communication percentage setting of auxiliary channel frequency B	-100.00% to 100.00% (100% = maximum frequency)
7003H	Torque communication setting	-200.00% to 200.00% (100% = digital torque setting)
7004H	Communication setting of process PID setting	-100.00% ~ 100.00%
7005H	Communication setting of process PID feedback	-100.00% ~ 100.00%
7006H	Voltage setting of VF separation mode	0.00% to 100.00% (digital setting reference)
7007H to 7009H	Reserved	
700AH	Communication percentage setting of upper frequency limit	0.00% to 200.00% (digital setting reference)
700BH	Communication percentage setting of upper frequency limit of torque control	0.00% to 200.00% (digital setting reference)
700CH	Linear speed input for inertia compensation	0.00% to 100.00% (digital setting reference)
700DH to 700EH	Reserved	
700FH	Master-slave communication setting	-100.00% to 100.00% (maximum reference)
7010H to 7013H	Reserved	
7014H	External	Protection input of external device

		protection	(including option card)	
	7015H	Communication setting of main channel frequency A	0.00 to maximum frequency	
	7016H	Communication setting of auxiliary channel frequency B	0.00 to maximum frequency	
	7017H	Communication setting of upper frequency limit	0.00 to maximum frequency	
	7018H	Communication setting of upper frequency limit of torque control	0.00 to maximum frequency	
	7019H	Communication setting of upper torque limit of speed control	0.0 to 250.0% (based on 100.0% or direct sending)	
	701AH	Communication setting 1	Communication setting by M1 terminal, communication address option 701AH	
	701CH~71FFH	Reserved		
Working status 7200H ~ 73FFH	7200H status word 1	Bit7 to 0 running status	00H	Parameter setting
			01H	Slave running
			02H	JOG running
			03H	Self-learning running
			04H	Slave stop
			05H	JOG stop
			06H	Protection status
			07H	Factory self-inspection
			08H - 0FFH	Reserved
	7201H status word 2	Bit15-8 protection information	00H	Normal running of inverter
			xxH	Inverter protection status, where "xx" is the protection code
	Bit0 setting direction	1	- setting is valid	
		0	+ setting is valid	
	Bit1 running direction	1	Reverse frequency output	
		0	Forward frequency output	

		Bit3 to 2 running mode	00	Speed control mode					
			01	Torque control mode					
			10	Reserved					
			11	Reserved					
		Bit4 parameter protection	1	Valid parameter protection					
			0	Invalid parameter protection					
		Bit6 - 5	Reserved						
		Bit8 to 7 setting mode	00	Keyboard control					
			01	Terminal control					
			10	Communication control					
	11		Reserved						
	Bit9	Reserved							
	Bit10 warning	0	No warning						
		1	Warning status (see 7230H for details)						
	Bit15 - 10	Reserved							
7202H monitoring frequency +/- status word 1 (1: -; 0: +)	Bit0	Output frequency							
	Bit1	Input frequency							
	Bit2	Synchronization frequency							
	Bit3	Reserved							
	Bit4	Estimate feedback frequency							
	Bit5	Estimated slip frequency							
	Bit6	Load rate							
Bit15 to 7	Reserved								
7203H	Output frequency								
7204H	Output voltage								
7205H	Output power								
7206H	Running speed								
7207H	Bus voltage								
7208H	Output torque								
7209H	Digital input 1	15	14	13	12	11	10	9	8
		*	*	*	*	*	*	*	*
		7	6	5	4	3	2	1	0
		*	*	*	X5	X4	X3	X2	X1
720AH	Digital input 2	15	14	13	12	11	10	9	8
		VX8	VX7	VX6	VX5	VX4	VX3	VX2	VX1
		7	6	5	4	3	2	1	0
		*	*	*	*	*	*	AI2	AI1
720BH	Digital output 1	15	14	13	12	11	10	9	8
		*	*	*	*	*	*	*	*
		7	6	5	4	3	2	1	0
		*	*	*	*	*	Y1	*	R1

	720CH	Digital output 2	15	14	13	12	11	10	9	8
			VY8	VY7	VY6	VY5	VY4	VY3	VY2	VY1
			7	6	5	4	3	2	1	0
			*	*	*	*	*	*	*	*
	720DH	Previous two protections								
	720EH	Previous three protections								
	720FH	Last protection								
	7210H	Output frequency of the last protection								
	7211H	Output current of the last protection								
	7212H	Bus voltage of the last protection								
	7213H	Running status of the last protection								
	7214H	Working time of the last protection								
	7215H	Set acceleration time								
	7216H	Set deceleration time								
	7217H	Cumulative length								
	7218H	Reserved								
	7219H	UP/DOWN offset frequency symbol (0/1: +/-)								
	7224H	Output current								
	7225H	Set frequency								
	7228H	Cumulative power-on time								
722FH	The fault number									
7230H	Warning number	0: no warning; others: current warning sign								
Other - 73FFH	Reserved									
Product information 7500H ~ 75FFH	7500H	Performance software S/N1				Corresponding to the function code F12.22				
	7501H	Performance software S/N2				Corresponding to the function code F12.23				
	7502H	Functional software S/N 1				Corresponding to the function code F12.24				
	7503H	Functional software S/N 2				Corresponding to the function code F12.25				
	7504H	Keyboard software serial number 1				Corresponding to the function code F12.26				
	7505H	Keyboard software serial number 2				Corresponding to the function code F12.27				
	7506H	Serial No. 1				Corresponding to the function code F12.28				
	7507H	Serial No. 2				Corresponding to the function code F12.29				
	7508H	Serial No. 3				Corresponding to the function code F12.30				

	7509H~ 75FFH	Reserved	
Others	Reserved		

### 11.3.5 Definition of frame data length

The PDU part of the RTU frame of the MODBUS message is able to read/write 1-16 registers. For different function codes, the actual length of the RTU frame varies, as detailed in Table 12- 32.

Table 12- 32 Correspondence between RTU Frame Length and Function Code

Function code (0x)	RTU frame length (bytes)			Maximum length (Byte)
	Request	Normal response	Exception response	
03	8	$5+2N_r^{[4]}$	5	37
41 (06)	8	8	5	8
08	8	8	5	8
42 (10)	$9+2N_w^{[5]}$	8	5	41

[4]:  $N_r \leq 16$ , indicating the number of requests to read registers;

[5]:  $N_w \leq 16$ , indicating the number of requests to write registers.

[6]:  $N_w + N_r \leq 16$ ;

### 11.3.6 CRC check

The low byte of CRC check is in front of the high byte.

The transmitter first calculates the CRC value, which is included in the sent message. Upon receiving the message, the receiver will recalculate the CRC value and compare the calculated value with the received CRC value. If the two values are not equal, it means that there is an error in the sending process.

Calculation process of CRC check:

- (1) Define a CRC register and assign an initial value, FFFFH.
- (2) Perform the XOR calculation with the first byte of the transmitted message and the value of the CRC register, and store the result in the CRC register. Starting from the address code, the start bit and stop bit are not involved in calculation.
- (3) Extract and check the LSB (the least significant bit of the CRC register).
- (4) If the LSB is 1, each bit of the CRC register is shifted to the right by one bit, and the most significant bit is supplemented by 0. Perform the XOR calculation of the value of the CRC register and A001H, and store the result in the CRC register.



- (5) If the LSB is 0, each bit of the CRC register is shifted to the right by one bit, and the most significant bit is supplemented by 0.
- (6) Repeat the steps 3, 4, and 5 until 8 shifts are completed.
- (7) Repeat the steps 2, 3, 4, 5 and 6 to process next byte of the transmitted message, until all bytes of the transmitted message are processed.
- (8) After the calculation, the content of the CRC register is the value of CRC check.
- (9) In a system with limited time resources, it is recommended to perform CRC check by the table lookup method.

The simple function of CRC is as follows (programmed in C language):

```
unsigned int CRC_Cal_Value(unsigned char *Data, unsigned char Length)
{
    unsigned int crc_value = 0xFFFF;
    int i = 0;
    while(Length--)
    {
        crc_value ^= *Data++;
        for(i=0;i<8;i++)
        {
            if(crc_value & 0x0001)
            {
                crc_value = (crc_value>>1)^ 0xa001;
            }
            else
            {
                crc_value = crc_value>>1;
            }
        }
    }
    return(crc_value);
}
```

This only describes the theory of CRC check and requires a long execution time. Especially



```
0xA0,0x60,0x61,0xA1,0x63,0xA3,0xA2,0x62,0x66,0xA6,0xA7,0x67,0xA5,0x65,0x64,0xA4,  
0x6C,0xAC,0xAD,0x6D,0xAF,0x6F,0x6E,0xAE,0xAA,0x6A,0x6B,0xAB,0x69,0xA9,0xA8,0x68,  
0x78,0xB8,0xB9,0x79,0xBB,0x7B,0x7A,0xBA,0xBE,0x7E,0x7F,0xBF,0x7D,0xBD,0xBC,0x7C,  
0xB4,0x74,0x75,0xB5,0x77,0xB7,0xB6,0x76,0x72,0xB2,0xB3,0x73,0xB1,0x71,0x70,0xB0,  
0x50,0x90,0x91,0x51,0x93,0x53,0x52,0x92,0x96,0x56,0x57,0x97,0x55,0x95,0x94,0x54,  
0x9C,0x5C,0x5D,0x9D,0x5F,0x9F,0x9E,0x5E,0x5A,0x9A,0x9B,0x5B,0x99,0x59,0x58,0x98,  
0x88,0x48,0x49,0x89,0x4B,0x8B,0x8A,0x4A,0x4E,0x8E,0x8F,0x4F,0x8D,0x4D,0x4C,0x8C,  
0x44,0x84,0x85,0x45,0x87,0x47,0x46,0x86,0x82,0x42,0x43,0x83,0x41,0x81,0x80,0x40  
};
```

```
UInt16CRC(UInt8 * buffer, UInt8 crc_len)
```

```
{  
    UInt8  crc_i,crc_lsb,crc_msb;  
    UInt16 crc;  
    crc_msb = 0xFF;  
    crc_lsb = 0xFF;  
    while(crc_len--)  
    {  
        crc_i = crc_lsb ^ *buffer;  
        buffer ++;  
        crc_lsb = crc_msb ^ crc_l_tab[crc_i];  
        crc_msb = crc_h_tab[crc_i];  
    }  
    crc = crc_msb;  
    crc = (crc << 8) + crc_lsb;  
    return crc;  
}
```

- CRC16 lookup table for the 16-bit processor: (The high byte in the final result of this program is in front. Please reverse it during sending.)

```
const UInt16 crc_table[256] = {  
0x0000,0xC1C0,0x81C1,0x4001,0x01C3,0xC003,0x8002,0x41C2,0x01C6,0xC006  
,0x8007,0x41C7,0x0005,0xC1C5,0x81C4,0x4004,0x01CC,0xC00C,0x800D,0x41CD  
,0x000F,0xC1CF,0x81CE,0x400E,0x000A,0xC1CA,0x81CB,0x400B,0x01C9,0xC009
```

,0x8008,0x41C8,0x01D8,0xC018,0x8019,0x41D9,0x001B,0xC1DB,0x81DA,0x401A  
,0x001E,0xC1DE,0x81DF,0x401F,0x01DD,0xC01D,0x801C,0x41DC,0x0014,0xC1D4  
,0x81D5,0x4015,0x01D7,0xC017,0x8016,0x41D6,0x01D2,0xC012,0x8013,0x41D3  
,0x0011,0xC1D1,0x81D0,0x4010,0x01F0,0xC030,0x8031,0x41F1,0x0033,0xC1F3  
,0x81F2,0x4032,0x0036,0xC1F6,0x81F7,0x4037,0x01F5,0xC035,0x8034,0x41F4  
,0x003C,0xC1FC,0x81FD,0x403D,0x01FF,0xC03F,0x803E,0x41FE,0x01FA,0xC03A  
,0x803B,0x41FB,0x0039,0xC1F9,0x81F8,0x4038,0x0028,0xC1E8,0x81E9,0x4029  
,0x01EB,0xC02B,0x802A,0x41EA,0x01EE,0xC02E,0x802F,0x41EF,0x002D,0xC1ED  
,0x81EC,0x402C,0x01E4,0xC024,0x8025,0x41E5,0x0027,0xC1E7,0x81E6,0x4026  
,0x0022,0xC1E2,0x81E3,0x4023,0x01E1,0xC021,0x8020,0x41E0,0x01A0,0xC060  
,0x8061,0x41A1,0x0063,0xC1A3,0x81A2,0x4062,0x0066,0xC1A6,0x81A7,0x4067  
,0x01A5,0xC065,0x8064,0x41A4,0x006C,0xC1AC,0x81AD,0x406D,0x01AF,0xC06F  
,0x806E,0x41AE,0x01AA,0xC06A,0x806B,0x41AB,0x0069,0xC1A9,0x81A8,0x4068  
,0x0078,0xC1B8,0x81B9,0x4079,0x01BB,0xC07B,0x807A,0x41BA,0x01BE,0xC07E  
,0x807F,0x41BF,0x007D,0xC1BD,0x81BC,0x407C,0x01B4,0xC074,0x8075,0x41B5  
,0x0077,0xC1B7,0x81B6,0x4076,0x0072,0xC1B2,0x81B3,0x4073,0x01B1,0xC071  
,0x8070,0x41B0,0x0050,0xC190,0x8191,0x4051,0x0193,0xC053,0x8052,0x4192  
,0x0196,0xC056,0x8057,0x4197,0x0055,0xC195,0x8194,0x4054,0x019C,0xC05C  
,0x805D,0x419D,0x005F,0xC19F,0x819E,0x405E,0x005A,0xC19A,0x819B,0x405B  
,0x0199,0xC059,0x8058,0x4198,0x0188,0xC048,0x8049,0x4189,0x004B,0xC18B  
,0x818A,0x404A,0x004E,0xC18E,0x818F,0x404F,0x018D,0xC04D,0x804C,0x418C  
,0x0044,0xC184,0x8185,0x4045,0x0187,0xC047,0x8046,0x4186,0x0182,0xC042  
,0x8043,0x4183,0x0041,0xC181,0x8180,0x4040};

Uint16 CRC16(Uint16 \*msg , Uint16 len){

    Uint16 crcL = 0xFF , crcH = 0xFF;

    Uint16 index;

    while(len--){

        index = crcL ^ \*msg++;

        crcL = ((crc\_table[index] & 0xFF00) >> 8) ^ (crcH);

        crcH = crc\_table[index] & 0xFF;

    }

```
return (crcH<<8) | (crcL);
}
```

### 11.3.7 Exception response

When the master station sends a request to the slave station, the master station expects a normal response. Query of the master station may result in one of the following four events:

- If a request without communication error is received from the slave station and can be processed properly, a normal response will be returned by the slave station.
- If the slave station does not receive a request due to communication errors, no message will be returned. This will be regarded as a timeout by the slave station.
- If the slave station receives a request but detects a communication error (parity, address, frame error, etc.), no response will be returned. This will be regarded as a timeout by the slave station.
- If the slave station receives a request without communication error but cannot process the request (e.g. a request to read the non-existent register), the slave station will return an exception response and the master station will be informed of the actual error.

The exception response message has two fields different from those of the normal response:

- **Function code field:** In the normal response, the slave station copies the function code of the original request in the corresponding function code field. The MSB values of all function codes are 0. In the exception response, the MSB of the function code is set to 1 by the slave station. That is, **the exception response function code = normal response function code + 0x80.**
- **Data field:** The slave station can return the data from the data field in the normal response and exception code in the exception response. For the defined exception codes, Table 4-33 Definitions of Exception CodesTable 4-33.

Table 4-33 Definitions of Exception Codes

Exception code	Item	Meaning
01H	Illegal function	The function code received by the slave station (inverter) is beyond the configured range (see 11.3.3Function <b>code</b> ).
02H	Illegal data	The data address received by the slave station (inverter) is not

	address	allowed. In particular, the combination of the start address of the register and the transmission length is invalid (see 11.3.4Register <b>address distribution</b> ).
03H	Illegal data frame	The slave station (inverter) has detected the incorrect query data frame length or CRC check.
04H	Slave protection	When the slave station (inverter) tries to execute a requested operation, an unrecoverable error occurs. This may be caused by the logic error, failure to write to the EEPROM, etc.
05H	Data over-range	The data received by the slave station (inverter) is not between the minimum and maximum values of the corresponding register.
06H	Parameter read-only	The current register is read-only and cannot be written.
07H	Unchangeable parameter in running	When the inverter is in the running status, the current register cannot be written. If necessary, please shut down the inverter.
08H	Parameter protection by password	The current register is protected by a password.

## 11.4 Protocol Description

### 11.4.1 Definition of inter-frame and intra-frame time interval

A complete MODBUS message contains not only the necessary data units, but also the starting and ending tags. Thus, as shown in Fig. 12- 20 or Fig. 4- 22, the idle level with a transmission time of 3.5 characters or more is defined as the starting and ending tag. If there is an idle level with a transmission time of more than 1.5 characters during message transmission, the transmission will be deemed exceptional.

Specific starting/ending and exception intervals are related to the baud rate, as detailed in Table 4- 34. If the baud rate is 9600bps and the sampling period is 1ms, the starting and ending time interval is the idle level of 4ms or more ( $3.5 \times 10 / 9600 = 3.64 \approx 4$ ), and the exceptional data interval is the idle level in which the interval of data bits of one frame is greater than or equal to 2ms ( $1.5 \times 10 / 9600 = 1.56 \approx 2$ ) and less than 4m (the idle level of normal data bits is less than or equal to 1ms).

Table 4- 34 Correspondence between Time Interval and Baud Rate ( $t_{adjust}=1ms$ )

Correspondence between Time Interval and Baud Rate ( $t_{adjust}=1ms$ )	Starting and ending time interval $T_{interval}$ ( $t_{adjust}$ )	Exception interval $T_{exception}$ ( $t_{adjust}$ )	Remarks
---	---	---	---------

4800	8	4	The idle level of 3ms or less is allowed for a normal frame. When the idle level is 8ms or greater, it indicates the end of a frame of data.
9600	4	2	The idle level of 1ms or less is allowed for a normal frame. When the idle level is 4ms or greater, it indicates the end of a frame of data.
19200	2	1	The idle level of less than 1ms is allowed for a normal frame. When the idle level is 2ms or greater, it indicates the end of a frame of data.
<b>Higher</b>	<b>1</b>	<b>1</b>	<b>When an idle level of 1ms appears, it indicates the end of a frame.</b>

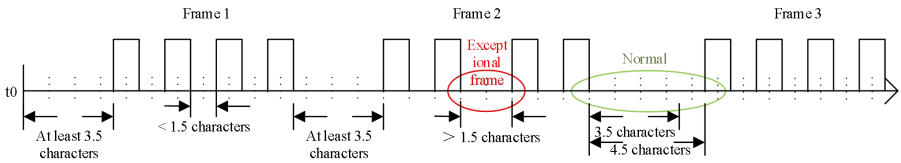

Fig. 4-22 Schematic Diagram of Normal and Exceptional Data Frames

### 11.4.2 Data frame processing

Upon receiving a frame data, the system will first perform preprocessing to determine whether it is a legal frame sent to this machine and check whether the data is correct, followed by final processing. If the received frame is not legal, the data will not be sent back. If the received frame is legal but incorrect, the corresponding exceptional message frame will be sent back.

**Legal frame:** Meet the address (local or broadcast) and length (not less than 3) requirements.

**Correct frame:** It is a legal frame with a correct memory address. The memory content is within the defined range and can be processed at present.

### 11.4.3 Response delay

The response delay (depending on the function code F10.04) is defined as the time interval from the reception of valid data frame<sup>[7]</sup> (data in the RS-485 network, different from the command sent by the keyboard) to data parsing and return. Since the starting and ending

characters are defined in the standard protocol, it is impossible to avoid response delay, at least “3.5-character time interval + 1 ms (chip stabilization time of 485 protocol,  $t_{wait2}$ )”. The specific minimum time interval is related to the baud rate. If the baud rate is 9600bps, the minimum response delay is 5ms ( $3.5 \times 10 / 9600 + 1 = 4.64 \approx 5$ ).

**If the communication data involves EEPROM operation, the time interval will be longer.**

[7]: Valid data frame: Sent by the external master station (not keyboard) to this machine. The function code, length and CRC of the data are correct.

Fig. 4-23 shows the data sending segment ( $t_{send}$ ), sending end segment ( $t_{wait1}$ ), 75176-to-sending wait segment ( $t_{wait2}$ ), data return segment ( $t_{return}$ ), and 75176-to-receiving wait segment ( $t_{wait3}$ ).

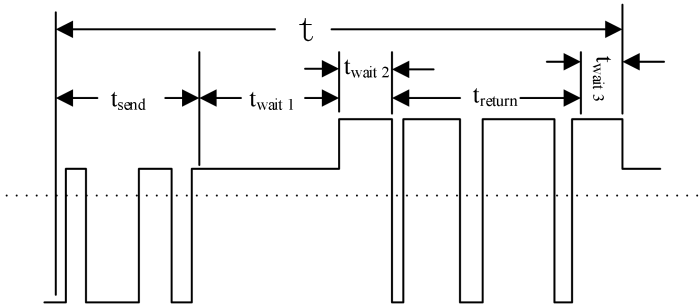

Fig. 4-23 Timing Parse Diagram of Complete Data Frame

**11.4.4 Communication timeout**

The communication time interval  $\Delta t$  is defined as the period from the previous reception of valid data frames by the slave station (inverter) to next reception of valid data frames. If  $\Delta t$  is greater than the set time (depending on the function code F10.03; this function is invalid if set to 0), it will be regarded communication timeout.



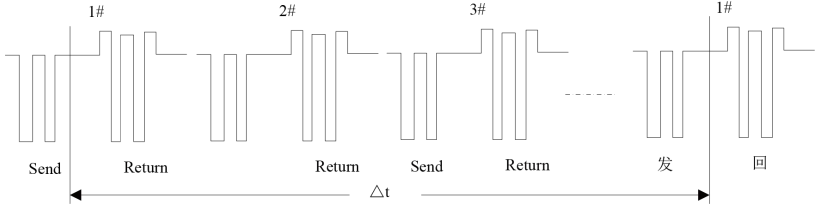

Fig. 4- 24 485 Schematic Diagram of Network Link Data

## 11.5 Examples

### 1) Forward running of inverter

Send: **01 41 70 0000 01 E6 C5**

Return: **01 41 70 0000 01 E6 C5 (normal)**

Return: **01 C1 04 70 53 (exception, assuming a slave protection)**

	Send the invoice to	Normal Return		Exception Return	
* Frame header	≥3.5 characters (idle)				
1 Address	01	Address	01	Address	01
2 Function code	41	Function code	41	Function code	C1
3 Register address Hi	70	Register address Hi	70	Exception code	04 (assumption)
4 Register address Lo	00	Register address Lo	00	CRC check Lo	70
5 Register value Hi	00	Register value Hi	00	CRC check Hi	53
6 Register value Lo	01	Register value Lo	01		
7 CRC check Lo	E6	CRC check Lo	E6		
8 CRC check Hi	C5	CRC check Hi	C5		
* Tail	≥3.5 characters (idle)				

### 2) Free stop of inverter

Send: **01 41 70 0000 07 66 C7**

Return: **01 41 70 0000 07 66 C7 (normal)**

Return: **01 C1 04 70 53 (exception, assuming a slave protection)**

	Send the invoice to	Normal Return		Exception Return	
* Frame header	≥3.5 characters (idle)				
1 Address	01	Address	01	Address	01
2 Function code	41	Function code	41	Function code	C1
3 Register address Hi	70	Register address Hi	70	Exception code	04 (assumption)
4 Register address Lo	00	Register address Lo	00	CRC check Lo	70
5 Register value Hi	00	Register value Hi	00	CRC check Hi	53
6 Register value Lo	07	Register value Lo	07		
7 CRC check Lo	66	CRC check Lo	66		

8	CRC check Hi	C7	CRC check Hi	C7	
*	Tail	≥3.5 characters (idle)			

**3) Command word for change of set frequency (e.g. 50.00Hz/1388H) (F00.04=7)**

Send: **01 41 70 15 13 88 3B 97**

Return: **01 41 70 15 13 88 3B 97 (normal)**

Return: **01 C1 04 70 53 (exception, assuming a slave protection)**

Send the invoice to		Normal Return		Exception Return	
*	Frame header	≥3.5 characters (idle)			
1	Address	01	Address	01	Address
2	Function code	41	Function code	41	Function code
3	Register address Hi	70	Register address Hi	70	Exception code
4	Register address Lo	15	Register address Lo	15	CRC check Lo
5	Register value Hi	13	Register value Hi	13	CRC check Hi
6	Register value Lo	88	Register value Lo	88	
7	CRC check Lo	3B	CRC check Lo	3B	
8	CRC check Hi	97	CRC check Hi	97	
*	Tail	≥3.5 characters (idle)			

**1) Read the information of last protection (read the function codes F19.00-F19.05)**

Send: **01 03 13 00 00 06 C1 4C**

Return: **01 03 0C 00 11 00 00 00 01 2C 00 00 00 0053 5B (normal)**

Return: **01 83 04 40 F3 (exception, assuming a slave protection)**

Send the invoice to		Normal Return		Exception Return	
*	Frame header	≥3.5 characters (idle)			
1	Address	01	Address	01	Address
2	Function code	03	Function code	03	Function code
3	Starting address Hi	13	Number of bytes	0C	Exception code
4	Starting address Lo	00	Register value Hi (F19.00)	00	CRC check Lo
5	Number (Hi) of registers	00	Register value Lo (F19.00)	11	CRC check Hi
6	Number (Lo) of registers	06	Register value Hi (F19.01)	00	
7	CRC check Lo	C	Register value Lo (F19.01)	00	
8	CRC check Hi	4	Register value Hi (F19.02)	00	
9			Register value Lo (F19.02)	00	
10			Register value Hi (F19.03)	01	
11			Register value Lo (F19.03)	2C	
12			Register value Hi (F19.04)	00	

13		Register value Lo (F19.04)	00	
14		Register value Hi (F19.05)	00	
15		Register value Lo (F19.05)	00	
16		CRC check Lo	53	
17		CRC check Hi	5B	
*	Tail	≥3.5 characters (idle)		

**2) Check whether the line is connected.**

Send: **01 08 00 00 AA 55 5E 94**

**Return: 01 08 00 00 AA 55 5E 94 (normal)**

**Return: 01 88 04 47 C3 (exception, assuming a slave protection)**

	Send the invoice to	Normal Return		Exception Return	
*	Frame header	≥3.5 characters (idle)			
1	Address	01	Address	01	Address
2	Function	08	Function	08	Function code
3	Sub-function code Hi	00	Sub-function code Hi	00	Exception code
4	Sub-function code Lo	00	Sub-function code Lo	00	CRC check Lo
5	Data Hi	AA	Data Hi	AA	CRC check Hi
6	Data Lo	55	Data Lo	55	
7	CRC check Lo	5E	CRC check Lo	5E	
8	CRC check Hi	94	CRC check Hi	94	
*	Tail	≥3.5 characters (idle)			

**3) Change the carrier frequency (F00.23) to 4.0kHz.** (use the function code 0x06 as such function codes are expected to be stored in EEPROM after change)

Send: **01 06 00 17 00 28 39 D0**

**Return: 01 06 00 17 00 28 39 D0 (normal)**

**Return: 01 86 04 43 A3 (exception, assuming a slave protection)**

	Send the invoice to	Normal Return		Exception Return	
*	Frame header	≥3.5 characters (idle)			
1	Address	01	Address	01	Address
2	Function code	06	Function code	06	Function code
3	Register address Hi	00	Register address Hi	00	Exception code
4	Register address Lo	17	Register address Lo	17	CRC check Lo
5	Register value Hi	00	Register value Hi	00	CRC check Hi
6	Register value Lo	28	Register value Lo	28	
7	CRC check Lo	39	CRC check Lo	39	
8	CRC check Hi	D0	CRC check Hi	D0	
*	Tail	≥3.5 characters (idle)			